



# EUROPEAN SOUTHERN OBSERVATORY

Organisation Européenne pour des Recherches Astronomiques dans l'Hémisphère Austral  
Europäische Organisation für astronomische Forschung in der südlichen Hemisphäre

ESO - European Southern Observatory  
Karl-Schwarzschild Str. 2, D-85748 Garching bei München

---

## Very Large Telescope

# SINFONI

## User Manual

**VLT-MAN-ESO-14700-3517**  
**Version 83, Date 2008/08/31**

Prepared ..... C. Dumas .....  
Date Signature

Approved ..... A. Kaufer .....  
Date Signature

Released ..... C. Dumas .....  
Date Signature

## **Change Record**

Issue/Rev.	Date	Section/Parag. affected	Reason/Initiation/Documents/Remarks
Issue 1	01/09/2004	all	First release, intended for phase 1 P75
Issue 1.1	21/10/2004	12	Template reference included for SV and GTO runs in Nov. 2004
Issue 1.2	05/01/2005		Version prepared for phase 2 of P75
Issue 1.3	24/05/2005	see section 1.3	Minor changes for phase 2 of P76
Issue 1.4	12/03/2006	all parts	Added information on availability of LGS and RRM modes for P78
Issue 78.1	2006/04/24	Cover & header	Issue number aligned with new format requirements for module archive
Issue 78.2	2006/06/07	Cover + templates	IP78 phase-2 (RRM, LGS, PRE-imaging. Also, the "AutoJitterOffset" template is not anymore offered.)
Issue 78.3	2006/06/25	Cover + throughout text	Small changes, mostly typos and english were corrected.
Issue 79.1	2006/09/09	all doc	Fixed some small inconsistencies wrt Period 79.
Issue 79.2	2006/11/27	all doc	Fixed some small inconsistencies throughout the text wrt grating wavelength range.
Issue 80.1	2007/02/17	all doc	Up-to-date for P80 (Phase 1)
Issue 80.2	2007/02/23	Section 5 & 12	Add availability of fast acquisition template in service mode (waiver required)
Issue 80.3	2007/05/25	All sections	Small changes for preparation of P80 (Phase 2), LGS info updated.
Issue 80.4	2007/06/13	2.1, 2.2, 12.2.3	Added info about orientation of field selector orientation and offsets in autojitter template.
Issue 81.1	2007/08/26	1.3, 2.1, 5.7, 8.2.2, 12.1	Some small updates for CfP81.
Issue 81.2	2007/09/06	2.1	Orientation of Field-Selector updated.
Issue 81.3	2007/09/10	2.1, 2.2, 8.2.2	Updated magnitude limite of TTS for LGS observations.
Issue 81.4	2007/12/04	12.2	Update for P81, Phase 2. Keyword change in auto_jitter template.
Issue 81.5	2007/12/05	12.2.2	Corrected sign error in caption of figure related to generic_offset sequence in SKY mode .
Issue 82.1	2008/02/28	1.3, 2.2, 3.3, 7.2, 12.0	Offering LGS without TTS on a best effort basis for P82 .
Issue 82.2	2008/05/28	5.6, 12.2	Explanation of PA convention and return to origin



### SINFONI in a Nutshell

SINFONI is a near-infrared ( $1.1 - 2.45 \mu\text{m}$ ) integral field spectrograph fed by a curvature sensing adaptive optics module. The spectrograph operates with 4 gratings (J, H, K, H+K) providing a spectral resolution around 2000, 3000, 4000 in J, H, K, respectively, and 1500 in H+K – each wavelength band fitting fully on the 2048 pixels of the Hawaii 2RG ( $2\text{k} \times 2\text{k}$ ) detector in the dispersion direction. The SINFONI field of view on the sky is sliced into 32 slitlets. Pre-optics allow to choose the angular size of the slices on the sky. The choices are 250 mas, 100 mas, 25 mas, leading to field of views on the sky of  $8'' \times 8''$ ,  $3'' \times 3''$ , or  $0.8'' \times 0.8''$  respectively. Each one of the 32 slitlets is imaged onto 64 pixels of the detector. Thus, one obtains  $32 \times 64 = 2048$  spectra of the imaged region of the sky. Typical limiting magnitudes ( $S/N=10$  in 1h on source) are around 17–18 mag in J,H,K.

SINFONI can be used without adaptive optics guide star, in which case the AO module just acts as relay optics and the spatial resolution is dictated by the natural seeing. In that case, the recommended slice width is 250 mas for an  $8'' \times 8''$  field of view. The full power of the instrument is, of course, achieved when an adaptive optics guide star is available. For best correction, the star should be brighter than  $R \sim 11$  mag. However, the AO can work (and will provide a moderate image quality improvement) with stars as faint as  $R \sim 17$  mag in the best seeing conditions. Ideally, the AO guide star should be as close as possible to the scientific target (if not the science target itself), and usually closer than  $10''$ . Depending on the atmospheric conditions (atmospheric coherence length) the AO guide star could be chosen as far as  $30''$  for the AO system to still provide a mild improvement of the encircled energy. SINFONI has started operation with the Laser Guide Star (LGS) in Period 79 (service mode only). The system is still evolving and currently provides Strehl ratio in the 10-20% range, under excellent seeing conditions. Tip-Tilt Stars (TTS) as faint as  $R \leq 18$  can be used, with a max separation of 1 arcmin from the science target. LGS requires CLEAR sky and is capable of non-negligible improvement in image quality under the best seeing conditions. It is expected to benefit a certain programs which could only be done in seeing limited mode before. Note that the LGS mode (resp. NGS mode) does not support differential tracking between the Tip Tilt Star (resp. NGS star) and the science target. As a result, observations of some solar system targets might be affected. A new LGS mode with no TTS (seeing enhancer) is currently being commissioned.

This page was intentionally left (almost) blank

# Contents

<b>1</b>	<b>Introduction</b>	<b>1</b>
1.1	Scope of this document . . . . .	1
1.2	Structure of this document . . . . .	1
1.3	Latest changes . . . . .	1
1.4	Glossary . . . . .	2
1.5	Abbreviations and Acronyms . . . . .	3
<b>I</b>	<b>Observing with SINFONI: from phase 1 to data reduction</b>	<b>4</b>
<b>2</b>	<b>SINFONI Performance overview</b>	<b>4</b>
2.1	Reference source for wavefront sensing . . . . .	4
2.2	Laser Guide Star (LGS) observations . . . . .	6
2.3	Spectrograph modes . . . . .	7
2.4	RRM mode . . . . .	7
2.5	Pre-Imaging mode . . . . .	7
2.6	Saturation limits . . . . .	7
2.7	Total instrument + telescope background . . . . .	8
2.8	Recommended DITs and NDITS, Object–Sky pattern . . . . .	8
<b>3</b>	<b>Phase 1: applying for observing time with SINFONI</b>	<b>9</b>
3.1	Is SINFONI the right instrument for your project? . . . . .	9
3.1.1	The AO guide star . . . . .	9
3.1.2	Limiting magnitudes . . . . .	9
3.2	The Exposure Time Calculator (ETC) . . . . .	10
3.3	Proposal form . . . . .	10
<b>4</b>	<b>Phase 2: Preparing your SINFONI observations</b>	<b>12</b>
4.1	Do you have all information in hand? . . . . .	12
4.2	SINFONI specifics to templates, OBs, and p2pp . . . . .	13
4.2.1	Templates . . . . .	13
4.2.2	Observing Blocks – OBs . . . . .	14
4.2.3	p2pp . . . . .	14
4.3	Finding Charts, README Files and OB Naming Conventions . . . . .	14
<b>5</b>	<b>Observing with SINFONI at the VLT</b>	<b>16</b>
5.1	Overview . . . . .	16
5.2	Visitor Mode Operations . . . . .	16
5.3	The influence of the Moon . . . . .	16
5.4	Target Acquisition . . . . .	17
5.5	Measuring the Strehl ratios, reference PSF stars . . . . .	17

5.6	Orientation convention . . . . .	17
5.7	Offset conventions and definitions . . . . .	18
5.8	Instrument and telescope overheads . . . . .	18
<b>6</b>	<b>The SINFONI data reduction pipeline</b>	<b>20</b>
6.1	Required Input Frames for the Pipeline . . . . .	20
6.1.1	Reference Files . . . . .	20
6.1.2	Raw frames . . . . .	20
6.1.3	Calibration Products . . . . .	21
6.2	Data Reduction Steps . . . . .	22
6.2.1	Detector Linearity and Bad Pixel Mask Determination . . . . .	22
6.2.2	Bad Pixel mask and Master Dark Determination . . . . .	22
6.2.3	Master Spatial Flat and bad pixel determination . . . . .	23
6.2.4	Detector's distortion and slitlet distances determination . . . . .	23
6.2.5	Wavelength solution determination . . . . .	23
6.2.6	Standard star data reduction . . . . .	24
6.2.7	PSF data reduction . . . . .	24
6.2.8	Science observations . . . . .	24
<b>II</b>	<b>SINFONI: a detailed description of the instrument</b>	<b>25</b>
<b>7</b>	<b>General description</b>	<b>25</b>
7.1	Observing with Adaptive Optics . . . . .	25
7.1.1	Atmospheric turbulence . . . . .	25
7.1.2	Adaptive Optics . . . . .	25
7.2	The Laser Guide Star mode . . . . .	27
7.2.1	Background information on LGS . . . . .	27
7.2.2	LGS mode at Paranal-UT4 . . . . .	27
7.3	Observing in the Near-Infrared . . . . .	28
7.3.1	Atmospheric Transmission . . . . .	28
7.3.2	Background Emission . . . . .	28
7.3.3	Spectrophotometric Calibration . . . . .	29
7.4	Integral Field Spectroscopy . . . . .	30
<b>8</b>	<b>The Adaptive-Optics Module</b>	<b>32</b>
8.1	AO-Module System Description . . . . .	32
8.1.1	The AO Adapter . . . . .	32
8.1.2	The Main Optics . . . . .	32
8.1.3	The Corrective Optics . . . . .	33
8.1.4	The Wavefront Sensor . . . . .	34
8.1.5	LGS mode elements . . . . .	35

8.1.6	Calibration Unit	37
8.2	AO-module System Performances	38
8.2.1	NGS performances	38
8.2.2	LGS performances	39
<b>9</b>	<b>The integral field spectrograph SPIFFI</b>	<b>41</b>
9.1	Pre-optics	41
9.2	Image slicer	41
9.3	Spectrometer collimator	41
9.4	Grating wheel	42
9.5	Spectrometer camera	43
9.6	Sky-spider	43
9.7	Detector characteristics	44
<b>10</b>	<b>Software Overview</b>	<b>45</b>
<b>III</b>	<b>Reference Material</b>	<b>47</b>
<b>11</b>	<b>The SINFONI scientific calibration plan</b>	<b>47</b>
11.1	The science calibrations in a nutshell	47
<b>12</b>	<b>SINFONI template reference</b>	<b>48</b>
12.1	Acquisition Templates	49
12.1.1	SINFONI_ifs_acq_NGS	51
12.1.2	SINFONI_ifs_acq_NGSfast	52
12.1.3	LGS acquisition template	53
12.1.4	SINFONI_ifs_acq_noAO	53
12.1.5	RRM acquisition templates	54
12.2	Science Templates	54
12.2.1	SINFONI_ifs_obs_FixedSkyOffset	56
12.2.2	SINFONI_ifs_obs_GenericOffset	57
12.2.3	SINFONI_ifs_obs_AutoJitter	59
12.2.4	SINFONI_ifs_obs_AutoJitterSpider	59
12.3	Nighttime Calibration Templates	60
12.3.1	SINFONI_ifs_cal_StandardStar	61
12.3.2	SINFONI_ifs_cal_PSF	61
12.3.3	SINFONI_ifs_cal_NGS	61
12.3.4	SINFONI_ifs_cal_ArcsAtt	62
12.3.5	SINFONI_ifs_cal_LampFlatsAtt	63
12.4	Daytime Calibration Templates	63
<b>13</b>	<b>The Spectral Resolution of SINFONI</b>	<b>65</b>

# 1 Introduction

## 1.1 Scope of this document

The SINFONI user manual provides comprehensive information about the technical characteristics of the instrument, observations procedures and the data reduction of SINFONI data. The actual version was updated with the latest information about the detector and observing modes offered. We welcome any comments and suggestions which should be addressed to our user support group – [usd-help@eso.org](mailto:usd-help@eso.org).

This release was prepared to support the Call for Proposal (CfP) for Period 83.

## 1.2 Structure of this document

The document is structured in 3 parts. Part 1 (I) takes you step by step through the essentials (writing your proposal in phase 1, preparing your observations in phase 2, conducting your observations at the telescope and reducing your data). If you want to learn more about the instrument itself, you might want to read through Part 2 (II). Finally, Part 3 (III) contains the SINFONI calibration plan, a description of the templates and collected useful reference material.

## 1.3 Latest changes

No changes done for P83: The new LGS mode named "seeing-enhancer", which will not require a TTS (only the high-orders of aberration are corrected, no tip-tilt) has still not been fully commissioned. It will be offered on a best effort basis for P83 (i.e. there is slight still a risk that it will not be ready for the start of the period). Because this mode is still being commissioned, no performances estimate are yet available, but this mode will provide some improvement with respect to the seeing-limited mode. As a result, we suggest that anyone interested in this mode should visit regularly the SINFONI webpage ( <http://www.eso.org/instruments/sinfoni>) for the latest update. Note that this mode will require seeing constraints of 0.8" or better.

Minor changes but important announcements had also been made for P81 Phase 1 & 2:

- The use of the fast acquisition template is offered in service mode, but a waiver needs to be submitted to the User Support Department at the time of preparation of the Phase 2 OBs (see <http://www.eso.org/observing/p2pp/SINFONI/SINFONI-P2PP.html> for additional information).
- The Paranal's Rapid Response Mode is offered for SINFONI since period 78 (see <http://www.eso.org/observing/p2pp/rrm.html> for more information about the RRM mode). The Rapid Response Mode (RRM), is offered for observations of transient phenomena such as gamma-ray bursts or supernovae in semi-automatic mode. The user (PI or Co-I of an approved target-of-opportunity program) submits an ftp file with the coordinates of the target to a specific ftp server on Paranal. A special program at the telescope continuously monitors this ftp directory; when it detects a file, it checks if the filename corresponds to an approved activation code, and if this is the case, and if the required instrument is currently used at the UT, the on-going observations are ended, and a new BOB starts an OB with the same name as the ftp file. The telescope automatically presets to the coordinates specified in the ftp file, and the requested observations are performed straight away. PIs of approved SINFONI ToO programs requesting this mode need to prepare their OBs in the usual way. However, these RRM programs use specific acquisition

templates described in the template section of this manual (12).

- Although commissioning activities occurred until Sep. 2007, the Laser Guide Star (LGS) facility has been offered in service mode as early as Period 79. This mode provides significant improvement for programs which were limited to the no-AO mode, due to the lack of adequate natural guide star for the AO system. Note nevertheless that LGS observations can only be done under clear sky conditions and still require the use of a Tip-Tilt Star (TTS) to reach optimal correction. At the time being, Strehl improvement up to  $\sim 20\%$  have been measured under the best seeing conditions. TTS with  $R \leq 18$  have been successfully used with separation from the science target as large as  $\sim 1$  arcmin. LGS can only be used for programs having specifically requested this mode in the phase 1 proposal, and after approval given by the OPC.

## 1.4 Glossary

**Active optics:** is the active control of the primary and secondary mirrors of the *telescope*. It is performed using a telescope guide star.

**Adaptive optics:** is the correction of wavefront errors induced by atmospheric turbulence. The wavefront is measured from a guide star (either NGS or LGS, see below), and the corrections are sent to the deformable mirror within the *instrument*. Although the instrument can run in closed loop without the active optics system controlling the primary and secondary mirrors, one gets better adaptive optics performance if the active optics system of the telescope is running.

- **Natural Guide Star, NGS:** The astronomical object used to close the AO loop, usually a star, but it can also be an extended object as long as it provides sufficient contrast at visible wavelengths and fits within the wavefront sensor field of view ( $\sim 2.5$  arcsec).

- **Laser Guide Star, LGS:** The artificial star created by the sodium laser at an altitude of  $\sim 90$  km.

- **Tip-Tilt Star, TTS:** The star used in LGS mode to sense and correct tip-tilt aberrations.

## 1.5 Abbreviations and Acronyms

<b>AO</b>	Adaptive Optics
<b>APD</b>	Avalanche Photo-Diode
<b>DM</b>	Deformable Mirror
<b>DMD</b>	Data Management Division
<b>ESO</b>	European Southern Observatory
<b>ETC</b>	Exposure Time Calculator
<b>FC</b>	Finding Chart
<b>FoV</b>	Field of View
<b>FWHM</b>	Full Width at Half Maximum
<b>LGS</b>	Laser Guide Star
<b>MPE</b>	Max-Planck Institut für Extraterrestrische Physik
<b>NACO</b>	NAOS–CONICA or Nasmyth AO System–COude Near-Infrared CAmera
<b>NGS</b>	Natural Guide Star
<b>NIR</b>	Near InfraRed
<b>NOVA</b>	Nederlandse Onderzoekschool Voor Astronomie
<b>OB</b>	Observing Block
<b>P2PP</b>	Phase II Proposal Preparation
<b>PSF</b>	Point Spread Function
<b>QC</b>	Quality Control
<b>RRM</b>	Rapid Response Mode
<b>RTC</b>	Real Time Computer
<b>SINFONI</b>	Spectrograph for INtegral Field Observations in the Near Infrared
<b>SPAXEL</b>	Spatial (resolution) Elements on the sky
<b>SM</b>	Service Mode
<b>SR</b>	Strehl Ratio
<b>TIO</b>	Telescope and Instrument Operator
<b>TTS</b>	Tip-Tilt Star
<b>USG</b>	User Support Group
<b>VLT</b>	Very Large Telescope
<b>VM</b>	Visitor Mode
<b>WF</b>	Wave Front
<b>WFS</b>	Wave Front Sensor

## Part I

# Observing with SINFONI: from phase 1 to data reduction

## 2 SINFONI Performance overview

The following section gives a brief overview of the SINFONI performances. We will present more information in Section 8.2 and we refer to the exposure time calculator (ETC) which should be used to estimate the feasibility of your science observations: The Exposure time calculator can be found at: <http://www.eso.org/observing/etc>

### 2.1 Reference source for wavefront sensing

For SINFONI (NGS or LGS), the curvature wavefront sensing occurs at optical wavelengths ( $<1\mu\text{m}$ ) with avalanche photo diodes (APDs), which show a high photon response over a very broad wavelength range.

A natural AO guide star (NGS) should ideally be bright, close and compact. We will present in this section a brief overview on what can be done with the available AO guide star for the user selected science targets.

Please note that there is no perfect correlation between seeing, NGS parameters (brightness, distance, ...) and the Strehl ratio of the obtained data. The coherence times and isoplanatic angles may be distributed over a relatively wide range for a given atmospheric optical seeing value (FWHM) and spectral range (J, H or K).

**The distance of the AO guide star:** Two identical field selectors, FS, (one for NGS, the other for LGS) allow to pick the AO guide star within a  $\sim 2' \times 1'$  field centered on the spectrograph field. **Note that the vertical axis of the FS field of view is rotated by  $\sim 25$  deg., i.e. the Y-axis is positioned  $\sim 25$  deg. clockwise from East (see Fig. 1). A check has been introduced in P2PP to inform the user in case the selected reference star is located outside the range of the FS, or if the sequence of offsets bring the FS beyond its mechanical limit.** However, it is important to note that the AO performance will strongly degrade for AO guide stars at distances greater than 10 to 15 seconds depending on the selected wavelength band (J,H or K). Under excellent conditions, bright stars as far as  $20'' - 30''$  can still be used to provide a mild improvement of the image quality.

**The brightness of the AO guide star:** The intra- and extra-focal pupil of the AO guide star is imaged on a lenslet array, and each lenslet fed to an Avalanche Photo Diode (APD) that ultimately forwards its signal to the Real Time Computer (RTC).

The flux on the APD is limited to 1 million counts (in order not to damage the devices) and thus, stars brighter than  $R \sim 11$  mag are dimmed by a set of neutral density filters (for up to  $\sim 9$  mag). Hence, stars brighter than  $R \sim 2$  mag cannot be used as AO guide star. Stars brighter than  $R \sim 11$  mag will not improve further the performance of the AO system.

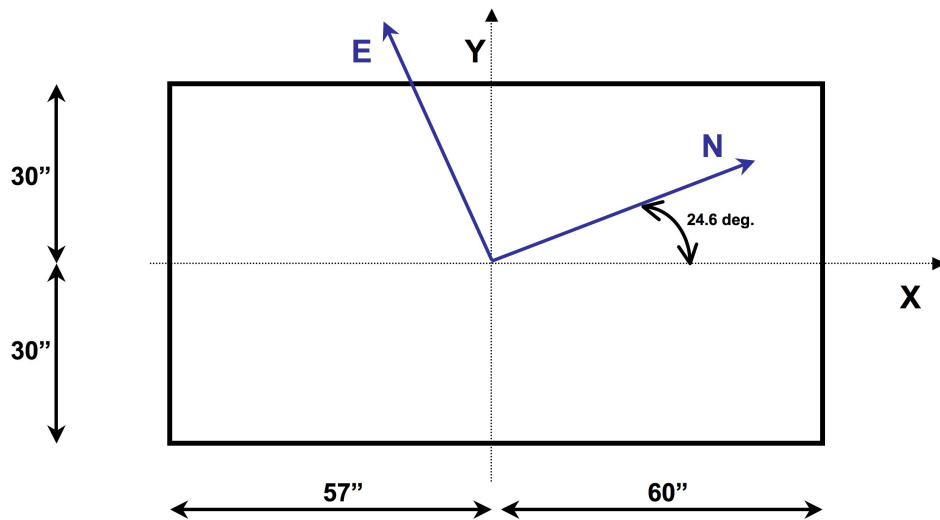

Figure 1: Orientation and size of the Field Selector field-of-view.

Good correction under average seeing is still obtained with stars as faint as  $R \sim 14$  mag. Any fainter guide star will then require very good or excellent atmospheric conditions to obtain diffraction limited images. Partial correction may be obtained down to  $R \sim 17$  magnitudes.

**In Service mode:** AO observations with AO guide stars much fainter than  $R \sim 14$  mag will require excellent observing conditions. The feasibility of such a project must be carefully evaluated and the derived observing constraints should be well selected in the proposal as well as in the later phase of observation preparation.

**In Visitor mode:** the above recommendation for service mode projects is also valid in visitor mode. In cases in which there is only a faint AO guide star, one would, in parallel, prepare observations for no AO, seeing limited observations. These backup projects for periods in which the AO loop cannot be closed on faint target should be authorized well in advance to the observation run, unless the science objectives as given in the proposal can be reached with seeing limited observations as well.

**The color of the AO guide star** The color of the guide star is important for two reasons:

- The very broad response curve of the APDs extends from 450nm to 900nm with the peak response around 650nm. Thus, the R band magnitude provides only a crude estimate of the number of photons detected by the Wave-Front Sensor (WFS). For M-stars and later spectral

types as well as for other very red objects ( $B-R > 2.2$ ) there will be less light detected by the APDs than for a guide star with a flat spectrum of the same magnitude.

- The color is also essential for atmospheric refraction compensation. The WFS corrects the telescope guiding for the atmospheric refraction difference between its (optical) guiding wavelength and the (near-infrared) central wavelength of the spectrograph set-up. Once the response curve of the WFS is taken into account, the optical guiding wavelength can be derived from the (B-R) color as follows:

$$\text{Guiding wavelength(nm)} = 590 + 40 * (B-R)$$

The observation software will take care of the guiding wavelength once the color is entered into the observation templates.

## 2.2 Laser Guide Star (LGS) observations

At the time of updating this manual, the performances of SINFONI in LGS mode have not been fully characterized. Strehl improvements have been measured in the 10% range under median seeing conditions and up to  $\sim 20\%$  under the best seeing conditions. Tip-Tilt stars with  $R \leq 18$  have been successfully used up to  $\sim 1$  arcmin from the science target (limit of the TTS field-selector mount). A new LGS mode (seeing enhancer) is tentatively offered on a best effort basis for P82. This mode does not require the use of a TTS.

This section provides the necessary information for Phase I preparation using LGS. More information will be provided on the SINFONI website (<http://www.eso.org/instruments/sinfoni>) as soon as they become available. **Note that LGS observations are only considered for service mode for the time being, and can only be carried out under clear (CLR) or photometric (PHO) conditions for sky transparency.**

In normal LGS mode, a Tip-Tilt Star (TTS) is required for tip-tilt measurements of the wavefront. The TTS needs to be located within a strict maximum distance of 1' from the science target (the field accessible to the Strap Field Selector is 1'x2', see previous section for a description of the field selector orientation). The TTS should also be brighter than  $R_{mag}=18$ , ideally in the  $R_{mag}$  12-18 range. Note nevertheless that the correction will be strongly degraded with increasing distance of the TTS from the science target, and decreasing brightness of the TTS. By comparison with the case of an on-axis NGS star, under median seeing conditions for Paranal, the achieved Strehl ratio will be degraded by a factor of two for a TTS that is 40" from the science target. It is also important to remember that due to the Cone effect, the maximum Strehl achievable with the LGS is significantly less than the one obtained with a bright NGS. The SINFONI ETC has now been updated to reflect observations with the LGS mode (see <http://www.eso.org/observing/etc>). FYI, one can expect the laser to create an artificial star whose magnitude will be  $V=12-13$ .

In summary, you must make sure that you have a TTS within 1 arcmin maximum from your object. You should clearly state why you need to use this mode, and include the characteristics of the TTS ( $V_{mag}$ , RA/DE, and spectral type if known). LGS observations can only be carried out under clear sky conditions (no cirrus or any type of clouds).

Starting P82, we also offer a new LGS mode not requiring the use of a TTS (no tip-tilt correction). Nevertheless, in addition to specifying CLR or better for the transparency, users requesting this mode must specify a seeing better than 0.8" in their phase I application.

## 2.3 Spectrograph modes

**Field of view** The pre-optics of the spectrograph allow to chose between 3 plate-scales, providing fields of  $8'' \times 8''$ ,  $3'' \times 3''$ ,  $0.8'' \times 0.8''$ . Each of these fields is then cut into 32 slices, and each slice is projected onto 64 detector pixels. Thus, the spatial resolution elements (spaxels) on the sky are rectangular.

Field of view	Spaxel size on the sky
$8'' \times 8''$	125mas $\times$ 250mas
$3'' \times 3''$	50mas $\times$ 100mas
$0.8'' \times 0.8''$	12.5mas $\times$ 25mas

**Wavelength bands** Four gratings are installed on a turret in the spectrograph: J,H,K, H+K. The dispersions are chosen such that the full wavelength range is covered by the detector in each case.

Band	Dispersion	FWHM of line	Resolution	$\lambda$ range
J	0.15nm/pix	$\sim$ 4pix	$\sim$ 2000	1.10 – 1.40 $\mu$ m
H	0.20nm/pix	$\sim$ 3pix	$\sim$ 3000	1.45 – 1.85 $\mu$ m
K	0.25nm/pix	$\sim$ 2pix	$\sim$ 4000	1.95 – 2.45 $\mu$ m
H+K	0.50nm/pix	$\sim$ 2pix	$\sim$ 1500	1.45 – 2.45 $\mu$ m

The characterization is complicated by the fact that the spectral PSF is different in each plate-scale, i.e. the FWHM of the spectral features (i.e. the spectral resolution) varies as a function of plate scale. See part III for details.

## 2.4 RRM mode

Rapid response Mode observations with SINFONI is offered starting period 78. Both NGS and no-AO modes are possible, although we expect most of the programs will not have a sufficiently bright nearby object to be used as NGS for the AO system. If AO can be used in NGS mode, please refer to the information available in section 2.1 to understand the limitation imposed by this mode. General information about Paranal's RRM observations is available at: <http://www.eso.org/observing/p2pp/rrm.html>

## 2.5 Pre-Imaging mode

In case of uncertainty concerning the feasibility of a program (source brightness, Strehl achieved for faint NGS star), you can request a pre-imaging run to obtain a small subset of data. Such dedicated pre-imaging run must be explicitly requested in the Phase 1 proposal.

## 2.6 Saturation limits

In open loop noAO observations the target should not be brighter than 5th magnitudes in J, H and K and 6th magnitude in H+K. In closed loop NGS observations neither the target nor the natural guide star must be brighter than these magnitudes (unless the fast acquisition template is used, in which case the limits are brighter by 1 and 2 magnitudes for the  $0.1''/\text{pix}$  and  $0.025''/\text{pix}$

scales respectively). These limits are set to avoid saturation during the acquisition which is by default taken with the widest  $8'' \times 8''$  scale. In visitor mode the acquisition on the widest scale may be avoided with the template SINFONI\_lifs\_acq\_NGS. This will however require excellent coordinates and additional precaution at the end of the observation when presetting to the next target.

**Note:** The detector can show a strong persistence effect, even after being illuminated below the saturation level (typically  $\sim 10\text{k}$  ADUs). This is being investigated. Note that if illumination was close or beyond saturation, the time scale to recover from the persistence is longer than an observing night!

## 2.7 Total instrument + telescope background

The total instrument + telescope background was measured in the 250 mas plate scale, as flux per pixel ( $250\text{mas} \times 125\text{mas}$ ) for the two cases “No OH avoidance” (averaging over the full spectral range), with “OH avoidance” (avoiding the brightest OH lines).

Band	incl. OH	between OH
J	0.14	$0.07 \text{ e}^-/\text{s}$
H	1.26	$0.11 \text{ e}^-/\text{s}$
K	3.64	$0.90 \text{ e}^-/\text{s}$
H+K	5.96	$0.80 \text{ e}^-/\text{s}$

This converts to the following magnitude per square arcseconds:

Band	incl. OH	between OH
J	15.9	16.7 mag
H	13.9	16.5 mag
K	12.6	14.2 mag
H+K	13.2	15.3 mag

## 2.8 Recommended DITs and NDITS, Object–Sky pattern

For long exposures on faint targets in which no saturation risk is given, we recommend to work with  $\text{NDIT}=1$ , and a DIT depending on the frequency with which the sky should be obtained. For exposure times longer than 150s it is mandatory in service mode to select the DIT from the recommended values of 150s, 300s, 600s or 900s.

For short exposures we recommend values of DIT of DIT0.83, 1, 2, 5, 10, 15, 20, 30, 60 or 100s to reduce the calibration load and to share the calibration data with other projects.

The standard templates support an ABBA pattern, that is Object and Sky frames are alternated with 50% of the total time spent on the Object. Observation sequences with Object–Sky patterns in which less time would be spent on the sky were tested as well (e.g. ABA or ABBA with different NDITS at the object and sky positions).

For sources smaller than the  $8'' \times 8''$  field of view there exists the possibility to obtain the sky background measurements within the field of view by applying offsets to place the targets into two or four corners of the field.

## 3 Phase 1: applying for observing time with SINFONI

This section will help you to decide whether SINFONI is the right instrument for your scientific project, take you through a quick evaluation of the observing time needed, and guide you through the particularities of SINFONI in the proposal form.

### 3.1 Is SINFONI the right instrument for your project?

#### 3.1.1 The AO guide star

In order to use the AO module in NGS mode, your target should be close ( $<10''$ ) to a bright ( $R < 14$  mag) guide star, or should be suitable as a guide star itself. Under these conditions the diffraction limit of the telescope can be approached or achieved.

Stars brighter than  $R \sim 11$  mag are dimmed using neutral density filters in order not to blind the APDs of the wave-front sensor.

Fainter guide stars can be used but the performance of the AO module degrades rapidly with fainter magnitudes. Under excellent conditions, guide stars with  $R \sim 17$  mag have been used providing a mild improvement of the image quality.

Guide stars as far as  $30''$  can also be used under very good conditions, but again, the patch of the atmosphere that will be corrected will not be the one located in front of your target, i.e. the image quality improvement on target will not be optimal. Guide stars further away than  $30''$  are generally not useful.

- **Seeing limited observations:** If no AO guide star is available or needed, the deformable mirror is flattened (using the calibration fiber during the target acquisition) and the AO module just acts as relay optics with 5 wave reflections. The shape of the deformable mirror has to be recalculated as soon as the telescope altitude (airmass) or parallactic angle has changed significantly (typically by more than 0.1 in airmass) since the last calibration of the mirror shape.

- **LGS observations:** Please refer to the information in Section 2.2 for LGS programs.

#### 3.1.2 Limiting magnitudes

Limiting magnitudes ( $S/N=5$  per spectral pixel, point sources, integrated over the typical size of the PSF, in 1h integration on source) are:

Field of View	Scale	mode	Limiting Magnitudes (continuum)
$8'' \times 8''$	250 mas	noAO	J=20.2, H=19.9, K=17.9, H+K=19.6
$3'' \times 3''$	100 mas	NGS	J=19.4, H=19.6, K=18.8, H+K=19.8
$0.8'' \times 0.8''$	25 mas	NGS	J=17.8, H=18.7, K=18.3, H+K=19.2

We have selected a seeing at visual wavelength of  $0.8''$  which would be equivalent to infrared seeing values of 0.67, 0.63, 0.59 and 0.61 for the central wavelength of the J, H, K and H+K spectral ranges respectively. For closed loop AO with natural guide star (NGS) we have assumed a NGS at a distance of  $10''$  and photometric brightness of  $R = 12$  and  $B-R = 1.5$  magnitudes.

For more detailed exposure time calculation, we encourage you to use the exposure time calculator.

## 3.2 The Exposure Time Calculator (ETC)

The SINFONI exposure time calculator can be found at:

<http://www.eso.org/observing/etc>

Exposure time calculator

It returns a good estimation of the integration time (on source!) needed in order to achieve a given S/N, as a function of atmospheric conditions.

A few words to the various *input parameters* (also read the online help provided on the ETC page):

- the parameters to be provided for the input target are standard. The input magnitude can be specified for a point source, for an extended source (in which case we compute an integration over the surface defined by the input diameter), or as surface brightness (in which case we compute values per square spaxel e.g.  $100 \times 100$  mas).
- if an AO guide star is used, do not forget to **tick the box AO** under instrument set-up, and provide the values for AO guide star distance, its R mag and (B-R) color. The two latter can be obtained from many of the online star catalogs (e.g. GSC II, USNO, UCAC, ...), and are used to compute how much photons will be available to the wavefront sensor (whose response curve ranges from 450nm to 900nm and peaks around 650nm).
- Sky conditions and instrument set-up should be trivial (if no AO guide star is available, reset the AO box!). Note that the seeing constraint in the proposal is at the observed wavelength for seeing limited observations, while the input to the ETC is always at V-band
- Results can be given as exposure time to achieve a given S/N or as S/N achieved in a given exposure time. In both cases, you are requested to enter a typical integration time DIT, and the S/N or the number of multiple reads (NDIT).

The *screen output from the ETC* will include the input parameters together with the calculated performance estimates. Here some additional notes about the ETC output values:

- The integration time is given on source: depending on your technique to obtain sky measurements, and accounting for overheads, the total observing time will be much larger.
- The S/N is given per spectral pixel, not per resolution element! i.e. to compute your S/N for a resolution element, make sure that you sum the right number of pixels (typically 2 in K and H+K bands, 3 in H band, 4 in J band).

Most of the other ETC parameters should be self-explanatory and well explained in the online help of the ETC.

## 3.3 Proposal form

SINFONI can be used with and without AO guide star. Your target list will not be checked for valid AO guide stars (as it is done e.g. for NACO).

Your choices of set-ups are given below. You are requested to tell us whether you will or will not use the AO. Note that we decided that it would make no sense to work with the 25 mas plate scale

if you are not using adaptive optics:

```
%\INSconfig{}{SINFONI}{PRE-IMG}{provide HERE list of setting(s) (J,H,K,H+K)}
%
%\INSconfig{}{SINFONI}{IFS 250mas/pix no-AO}{provide HERE list of setting(s) (J,H,K,H+K)}
%\INSconfig{}{SINFONI}{IFS 100mas/pix no-AO}{provide HERE list of setting(s) (J,H,K,H+K)}
%
% If you plan to use a NGS, please specify the NGS name and magnitude (Rmag preferred,
% otherwise Vmag) in target list.
%\INSconfig{}{SINFONI}{IFS 250mas/pix NGS}{provide HERE list of setting(s) (J,H,K,H+K)}
%\INSconfig{}{SINFONI}{IFS 100mas/pix NGS}{provide HERE list of setting(s) (J,H,K,H+K)}
%\INSconfig{}{SINFONI}{IFS 25mas/pix NGS}{provide HERE list of setting(s) (J,H,K,H+K)}
%
% If you plan to use the LGS, please specify the TTS name and magnitude (Rmag preferred,
% otherwise Vmag) in target list.
%\INSconfig{}{SINFONI}{IFS 250mas/pix LGS}{provide HERE list of setting(s) (J,H,K,H+K)}
%\INSconfig{}{SINFONI}{IFS 100mas/pix LGS}{provide HERE list of setting(s) (J,H,K,H+K)}
%\INSconfig{}{SINFONI}{IFS 25mas/pix LGS}{provide HERE list of setting(s) (J,H,K,H+K)}
%
% If you plan to use the LGS without TTS (seeing-enhancer mode) then please leave
% the TTS name blank in the target list.
%\INSconfig{}{SINFONI}{IFS 250mas/pix LGS-noTTS}{provide HERE list of setting(s) (J,H,K,H+K)}
%\INSconfig{}{SINFONI}{IFS 100mas/pix LGS-noTTS}{provide HERE list of setting(s) (J,H,K,H+K)}
%\INSconfig{}{SINFONI}{IFS 25mas/pix LGS-noTTS}{provide HERE list of setting(s) (J,H,K,H+K)}
%
%\INSconfig{}{SINFONI}{RRM}{yes}
```

## 4 Phase 2: Preparing your SINFONI observations

This section provides a preliminary guide for the observation preparation for SINFONI in phase 2, both for Service mode and Visitor mode.

We assume that you are familiar with the generic guidelines which can be found at:

- <http://www.eso.org/observing/observing.html> Proposal preparation
- <http://www.eso.org/observing/p2pp> Service mode informations
- <http://www.eso.org/paranal/sciops> Visitor mode informations

Nevertheless, we list here a few points that might be useful when thinking about your upcoming phase 2. The good news is that unlike several other instrument on the VLT, preparing observations for SINFONI does **not** require any special preparation software.

### 4.1 Do you have all information in hand?

A few considerations before starting the observation preparation phase:

- The **exact** coordinates of your targets. SINFONI has a very small field of view, and it is very easy to miss the target...
- If you observe in the NGS mode with a science target different from the AO guide star, it is *strongly recommended* to use coordinates for the AO guide star and science target from the same catalog/reference system. Further, the AO guide star coordinate should be accurate enough such that it is visible during the acquisition performed with the  $8'' \times 8''$  field of view (taking into account that the VLT pointing could be off by  $1'' - 2''$  ).
- If you observe in the LGS mode, please refer to section 2.2.
- If you observe a faint target without an AO guide star, you have two possibilities. 1) to specify the *telescope* guide star in your acquisition template, and provide the target coordinates in the same reference system – this will guarantee a pointing to typically 100–200 mas. Or 2) to point to a bright, nearby star and perform an offset from this star at the end of your acquisition. For this latter solution, the coordinates of your target and the bright star must be defined accurately and in the same reference system.
- You should put some careful thinking into the plate scale that you will use. Are your observations driven by the available field of view? Or do you need the highest possible spatial resolution available?
- You should have decided on the best strategy to obtain sky measurements. Note that unlike long slit spectrographs, the field of view (except maybe the largest one) is too small to nod and keep your object in the field of view. I.e. no “nod on slit” can be done. Thus, your sky measurements have usually to be obtained from offset fields, and the templates allow you several option (see Section 12). The frequency with which to obtain sky measurements depends on the band (more frequent in J,H, less in K) and on the accuracy with which you want to subtract them (variations of the order of minutes are usual, thus sky measurements could vary from anything between every 120s to every 600s, choose the same DIT, and vary the NDIT only if noise characteristics are not important for your subtraction.)

## 4.2 SINFONI specifics to templates, OBs, and p2pp

SINFONI follows very closely the philosophy set by the ISAAC (short wavelength) and NACO templates. It is simplified by the fact that SINFONI offers only one mode of observing: IFS – Integral Field Spectroscopy.

### 4.2.1 Templates

For an overview of the templates, we refer to Sec. 12. Only a rough outline of the templates is given below.

**Acquisition** Acquisition templates allow one to distinguish between the cases of observing without AO (`...acq_noAO`) and with an AO Guide Star (NGS or LGS) for AO corrections (`...acq_NGS`, `...acq_LGS`).

There are two particularities of the noAO acquisition templates:

- It allows to flag whether the Deformable Mirror (DM) should be flattened after the telescope preset, before the observations – this is mandatory to obtain the best image quality.
- It allows an end-offset to be made, i.e. to acquire a bright star and perform a known offset to the real target.

The acquisition for AO using a natural guide star has also a few particularities, concerning information on the AO guide star:

- It requires the absolute coordinates of the AO guide star. Unless you tick the box 'Target = AO Guide Star' in which case it will use the target.
- It also asks for the B-R color of the AO guide star. This is used to compute the guiding wavelength for the field selector holding the AO guide star. Which in turn is used to correct for atmospheric refraction effects.
- Finally, it requires the FWHM measured in R-band images (or at similar wavelength) of the AO Guide star in order to optimize a diaphragm in the AO system. This diaphragm is set as a function of the seeing such as to optimize the amount of light received from the object with respect to the amount of background light from the sky. If your object is a point source, leave this to be 0 (only the seeing will be taken into account). Only if your AO guide 'star' is significantly extended with respect to the seeing (i.e. comparable to the seeing value), this optimization parameter will have a noticeable effect.

Finally, both acquisition templates will usually acquire during the acquisition sequence a sky image to be subtracted from the object image (to enhance the contrast). The sky frame during the target acquisition may be skipped by the operator if the object is bright in the NIR (e.g. J,H or K<14 mag).

**Observing:** The observing templates are standard if you have observed with other NIR instruments at the VLT or NTT. They allow variations in the strategy of obtaining sky measurements.

**Calibration:** Darks, arc (wavelength calibration), and lamp (flat-field) exposures are taken during daytime as part of the calibration plan (see sect. 11).

If, for a particular reason, you wish to obtain arcs or lamps immediately after your exposure, you can attach the template `...cal_ArcsAtt` or `...cal_LampFlatsAtt` at the end of your OB. We have found during the commissioning phase that the instrument flexures were small and that night time calibrations may not be required.

If you wish to estimate exactly the image quality obtained on your AO guide star, you can insert in your OB the template `...cal_NGS` immediately after your acquisition. This will set back the AO guide star into the spectrograph field of view and obtain an image of the NGS which can later be used for performance/PSF analysis. Please note that such an image is *not* taken by default during the acquisition (unlike for NACO for example).

Telluric standard stars are part of the calibration plan for all your observations. PSF standard stars are *not*. If you wish to observe a PSF standard star, prepare a corresponding OB with the template `...cal_PSF`.

**Alignment of coadd images from different nights – faint targets, noAO only:** For the closed loop AO observation the position of the field selector mirror can be used to align coadd images taken in different nights. For open loop noAO observations of faint targets acquired with blind offsets it is recommended to add the template `SINFONI_ifs_cal_PSF` with the blind offset swapped in sign to take an image of the blind offset star.

#### 4.2.2 Observing Blocks – OBs

Any SINFONI science OB should contain one acquisition template, followed by a small number of science and optionally night time calibration templates.

There are only three calibration templates which may be attached to night time science SINFONI OBs:

- The special nighttime calibrations (`...cal_ArcsAtt` and `...cal_LampFlatsAtt`), that may only be attached at the end of the OB. OBs which include night time calibrations must contain only one instrument set-up (J, H, K or H+K) and the attached calibration templates at the end of the OB.
- And `...acq_NGS`, to be attached typically right after the acquisition template in order to record an image of the AO Natural Guide Star.

For the large majority of projects, the night time observation blocks will contain only one science template and the mandatory target acquisition template.

#### 4.2.3 p2pp

Using p2pp to prepare SINFONI observations does not require any special functions (no file has to be attached except for the finding chart, all other entries are typed).

### 4.3 Finding Charts, README Files and OB Naming Conventions

In addition to the general instructions on finding charts and README files that are available at:

<http://www.eso.org/observing/p2pp>

the following is recommended for SINFONI:

- The field of view of all finding charts should be 1' by 1' in size, with a clear indication of field orientation.
- Ideally, the finding chart should show the field in the NIR, or at least in the red, and the wavelength of the image should be specified in the FC or the README file.
- The AO guide star (if used) should be clearly marked.
- The bright star from which to offset (if used) should be clearly marked.
- The 8" × 8" field-of-view, as well as the final field-of-view should be marked.
- The OB names for PSF calibration stars should be prefixed with the string *PSF\_*. Other generic naming conventions common to all ESO instruments in service mode are PRE (pre-imaging), ToO (target of opportunity), MOV (moving target), CAL (calibration star for RV, flux, ...)
- The magnitude of the brightest object in all fields, including standard stars, should be explicitly given in the README file (or otherwise indicated on the Finding Charts).

## 5 Observing with SINFONI at the VLT

### 5.1 Overview

As with all other ESO instruments, users prepare their observations with the p2pp software. Acquisitions, observations and calibrations are coded via templates (Sec. 12) and two or more templates make up an Observing Block (OB). OBs contain all the information necessary for the execution of an observing sequence.

At the telescope, OBs are executed by the instrument operator. SINFONI and the telescope are setup according to the contents of the OB.

The SINFONI Real-Time Display is used to view the raw frame as well as the reconstructed images. During acquisition sequences, it is mostly used in reconstructed image mode, for a proper centering of the targets in the field. Scientific exposures are typically checked in the raw frame display mode, in order to view spectral features.

Beside a comprehensive overview of the instrument set-up, the wavefront pupil as well as other information on the AO system can also be displayed on a separate screen.

Daytime calibrations are executed the following morning by observatory staff.

### 5.2 Visitor Mode Operations

Information/policy on the Visitor Mode operations at the VLT are described at:

<http://www.eso.org/paranal/sciops>

Visitors should be aware that about 30 minutes of their time may be taken within the framework of the SINFONI calibration plan.

### 5.3 The influence of the Moon

Moonlight does not noticeably increase the background in any of the SINFONI modes, so there is no need to request dark or gray time for this reason. However, it is recommended not to observe targets closer than  $30^\circ$  to the moon to avoid problems linked to the telescope guiding/active optics system. The effect is difficult to predict and to quantify as it depends on too many parameters. Just changing the guide star often solves the problem. Visitors are encouraged to carefully check their target positions with respect to the Moon at the time of their scheduled observations. Backup targets are recommended whenever possible, and users are encouraged to contact ESO in case of severe conflict (i.e. when the distance to the Moon is smaller than  $30^\circ$ ). Visitors can use the tools that are available in <http://www.eso.org/observing/support.html> (select the link “airmass” which is under “User Support Tools”) to help determine the distance between targets and the moon for given dates.

However, the moon may affect the quality of the adaptive optics correction, if the source used for wavefront sensing is fainter than  $R=15$  mag. <sup>1</sup> In these cases, reducing the lunar illumination (FLI) constraint to approximately 0.7 and increasing the distance to the Moon to approximately 50 degrees is generally adequate. Even here, it is important not to over-specify the constraints, as this reduces the chances of the Observing Block to be executed.

---

<sup>1</sup>The aperture diameter of the wave front sensor is typically 3 times the measured value of the seeing.

## 5.4 Target Acquisition

We describe here very schematically the sequence of events occurring during the target acquisition.

The acquisition sequence for observation with AO-NGS is the following:

- Preset the telescope to the target coordinates
- Offset the telescope to the NGS guide star
- Interactively allow to center the NGS guide star
- Close the loop
- Change to final plate-scale, interactively allow to re-center the NGS (if final scale is different than large scale)
- Offset the telescope back to the target and re-center (if different from NGS)

The acquisition in AO-LGS is very similar to the acquisition in AO-NGS, with the differences that:

- The laser is first acquired (i.e. centered and focused) by the telescope operator
- The NGS guide star becomes the Tip-Tilt guide star (which can also be the target if bright enough)

The acquisition sequence for observation without AO is the following:

- Preset the telescope to the target coordinates
- Flatten the Deformable Mirror using the calibration fiber
- Offset the telescope to the reference (if science target is not visible) and interactively center it
- Change to final plate-scale, interactively allow to re-center the reference
- Offset the telescope back to the target and interactively center it

## 5.5 Measuring the Strehl ratios, reference PSF stars

The Strehl ratio is not measured by default during the AO acquisition. The real time computer returns an estimation of the Strehl ratio derived from its computations. This value is only an estimate and can be off by as much as  $\sim 20\%$  in some cases. We're currently investing a better calibration of the RTC Strehl.

If you wish to estimate the Strehl/PSF of the AO Guide Star, use the template `...cal_NGS` to record an image of the AO guide star.

Reference PSF stars can be obtained by preparing a dedicated OB using the `SINFONI_ifs_cal_PSF` template.

## 5.6 Orientation convention

Figure 2 shows the orientation convention used for SINFONI. A positive rotation of the Position Angle on sky, corresponds to a clockwise rotation of the orientation.

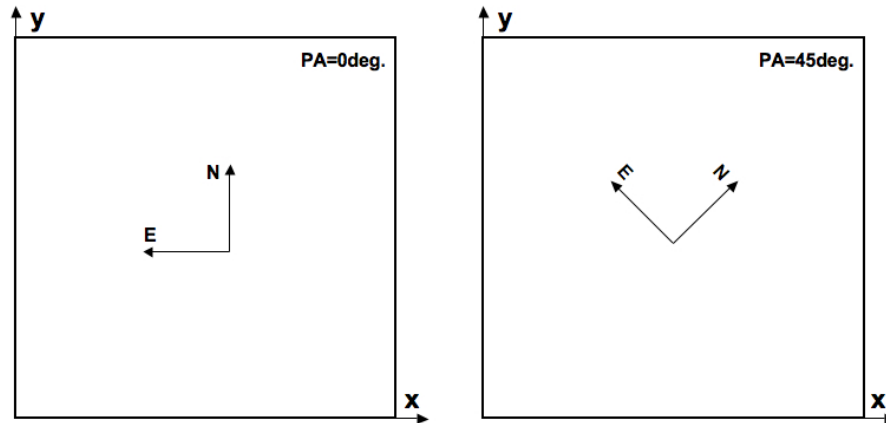

Figure 2: Illustration of the orientation convention of the Position Angle on Sky for a PA of 0deg. (left) and +45deg. (right).

## 5.7 Offset conventions and definitions

SINFONI follows the standard astronomical offset conventions and definitions.

All offsets are given in arc seconds, but the reference system can be chosen to be the sky (Alpha, Delta) or the Detector (X,Y).

For a position angle of 0, the reconstructed image on the RTD will show North up and East left. The positive position angle is defined from North to East.

Note that the templates use cumulative offsets!

That is, your position at a given time is derived from the *sum* of all offsets specified so far in the template.

For example, the series of offsets: 0, -10, 0, 10 brings you back to the original position for the last exposure. This could have been the definition of a series in which we define an exposure on object, followed by two sky exposures at -10'' of the original position, before pointing back on the object for the fourth exposure.

## 5.8 Instrument and telescope overheads

The telescope and instrument overheads are summarized below.

Hardware Item	Action	Time (minutes)
Paranal telescopes	Preset	6
Paranal telescopes	Offset	0.25
SINFONI	Acquisition no AO	3
SINFONI	Acquisition AO (NGS)	$2 + 4 * (\text{DIT} * \text{NDIT})$
SINFONI	Acquisition NGSfast	$\sim 2$
SINFONI	Acquisition LGS (added to AO (NGS) acq. time)	$\sim 9$
SINFONI	Centering of target (AO and no AO)	$4 + 4 * (\text{DIT} * \text{NDIT})$
SINFONI	Instrument setup (grating change)	2.5
SINFONI	Science exposure read-out (per DIT)	0.07
SINFONI	Detector setup overheads (per $\text{DIT} \times \text{NDIT}$ )	0.3

Note #1: for the Acquisition AO (NGS or LGS modes), the DIT and NDIT refer to the ones requested for the AO guide star (NGS or TTS).

Note #2: The instrument set-up is usually absorbed in the telescope preset. Changing the plate-scale within an OB is very fast (10s) and will not be charged as overhead. Changing grating within an OB is *very slow* (2.5 min on average).

The no AO acquisition takes 3 minutes, mostly used to drive in the calibration fiber, close the AO loop once in order to flatten the deformable mirror, and drive out the fiber. This way, you obtain the optimal image quality at the telescope preset for your observations.

## 6 The SINFONI data reduction pipeline

This section intends to provide a short overview of the frames required by the pipeline, as well as a very brief overview of the data reduction steps.

### 6.1 Required Input Frames for the Pipeline

#### 6.1.1 Reference Files

##### Reference Bad Pixel Map

The reference bad pixelmap marks the first and last four rows and columns of the detector as bad. This map must be combined with the other bad pixel maps created by recipes `si_rec_detlin` and `si_rec_bpmmap` to generate a master bad pixel map.

##### Line Reference Table

For distortion determination and wavelength calibration it is necessary to include a reference line table (`REF_LINE_ARC`). These are arc lamp and OH emission line lists (vacuum wavelength and relative intensities) obtained from the National Institute for Standard and Technology physical reference data or literature. Reference line lists should contain only those lines found within the band in question.

##### First column of first slitlet

If frame stacking is required a FITS table (`FIRST_COL`) giving the first column of the first slitlet for each spectral band and pre-optics is necessary. This value is assumed to be zero.

#### 6.1.2 Raw frames

##### Dark Frames

Produced by `SINFONI_ifs_cal_Darks`

Dark frames with exposure times corresponding to the exposure time of the object. Dark frames are used to correct for the instrument bias especially if no off- or sky-frames are available. They are also needed if the OH emission lines are used to track the instrumental flexure. In addition, dark frames are used to generate bad pixel maps.

##### Flat Fields

Produced by `SINFONI_ifs_cal_LampFlats`

Flat fields are used to correct for pixel to pixel sensitivity variations. A flat field should be generated for each spectral band and pre-optics.

There are several possible types of flat fields. Standard flat fields with constant intensities are used to generate master flat fields and static bad pixel maps. Linearity flat fields with increasing intensity are used to determine the detector's linearity and generate a bad pixel map for highly non-linear pixels.

Flats with an ad hoc DPR keyword (`FLAT_TEC`) are also taken together with fiber frames as part of the north south test to compute the detector's distortion.

##### Fiber Frames

Produced by `SINFONI_ifs_tec_NorthSouth`

Several frames obtained by placing a fiber at different positions. Used to determine the detector's geometric distortions and the slitlet distances for each spectral band.

### Arc Lamp Frames

Produced by SINFONI\_ifs\_cal\_Arcs

Arc lamp frames for wavelength calibration (neon+argon in *K*-band, xenon+argon in *H*, xenon in *H+K* and argon in *J*) or alternatively sky frames (OH lines) for each spectral band and pre-optics. These frames are used for wavelength calibration. The sky frames containing OH-lines can be used for a more precise wavelength calibration.

Arc lamp frames with an ad hoc DPR keyword (WAVE\_TECH) are also taken together with fiber frames as part of the north south test to compute the detector's distortion.

### Sky Frames

A sky frame must be subtracted from the object frames, since the nightsky emission lines are very bright and vary both spatially and in time in the near-infrared. The sky frame obtained closest in time and distance from the science field must be used - otherwise OH line remnants will appear in the final data cube. For this reason the sky frames must be included in the template definition.

Sky frames are produced by templates SINFONI\_ifs\_obs\_FixedSkyOffset, SINFONI\_ifs\_obs\_GenericOffset, SINFONI\_ifs\_cal\_StandardStar and SINFONI\_ifs\_cal\_PSF

### Standard star Frames

Produced by SINFONI\_ifs\_cal\_StandardStar

Standard star frames are used to flux calibrate the object frames and to remove the atmospheric transmission features. In some cases, they can also be used as PSF standards

### PSF standard Frames

Produced by SINFONI\_ifs\_cal\_PSF

PSF standard frames are used to generate PSF images. They can also be used for flux calibration and as telluric standards, similar to standard star frames.

When operating the pipeline in fully automatic mode, the PSF standard frames are reduced in recipe `si_rec_psf` and standard star frames in `si_rec_stdstar`. When manually using the pipeline through `esorex` or `gasgano`, they can be used interchangeably.

### Science Frames

Produced by SINFONI\_ifs\_obs\_AutoJitter, SINFONI\_ifs\_obs\_FixedSkyOffset and SINFONI\_ifs\_obs\_GenericOffset  
Science object frames. Can be used to generate publications.

## **6.1.3 Calibration Products**

### Bad Pixel Maps

Bad pixel maps determined with different methods may be combined to produce a more accurate bad pixel map. Static bad pixel masks are generated from dark frames or flatfields and they are used to interpolate the bad pixels. Dynamic bad pixels or cosmic rays are hopefully rejected by building clean means of several frames; if not, the reduction is highly affected by them due to error propagation during interpolation.

Quality of the bad pixel map is important to the quality of the end products, and especially the wavelength calibration and distortion determination are sensitive to the quality of the bad pixel maps. Since bad pixel maps are not expected to vary rapidly, maps from the calibration data base has been used with good results.

### Distortion

A fits table containing the coefficients for distortion correction. Geometric distortion depends on the spectral band used and is corrected for in stacked frames in North-South tests, wavelength calibrations and science data reduction.

In principle, distortion coefficients should be constant.

#### Slitlet Distances

A fits table describing the distances from one slitlet edge to another. Pixel distances of the slitlets depend on which spectral band is used. These distances are used in cube reconstruction.

Slitlet distances should remain constant unless the instrumental setup is changed.

#### Master Flat Field

Master flat fields are obtained by stacking on-off flat field frames. There is one master flat field for each band and preoptics.

Master flat fields should be generated each day.

#### Master Darks

Master darks are obtained by averaging dark frames with the same DIT. A master dark frame should be generated for each DIT used.

#### Slitlet edge position

Positions of the slitlet edges for each spectral band and pre-optics. These positions can be determined from a spectral arc lamp frame. Slitlet edge positions are used for bad pixel interpolation.

#### Wave Map

Wavelength calibration solution for each band and preoptics.

## **6.2 Data Reduction Steps**

In this subsection, methods used by the pipeline to generate calibration and science products are briefly described

### **6.2.1 Detector Linearity and Bad Pixel Mask Determination**

Recipe: `sinfo_rec_detlin`

Purpose: Bad/non-linear pixels determination

Linearity flat fields are sorted in a stack according to the intensity and on each pixel intensity variation through the stack is fit with a polynomial. A clean mean of the polynomials is computed, and pixels with polynomial coefficients deviating more than a user defined factor from the mean are flagged bad.

### **6.2.2 Bad Pixel mask and Master Dark Determination**

Recipe: `sinfo_rec_mdark`

Purpose 1: bad pixel mask generation

Frames are stacked, and on each pixel the standard deviation of intensity is computed. The clean mean of those values is calculated. The pixels which deviate more than a user defined factor times the standard deviation from the clean mean are flagged bad.

Purpose 2: Master Dark(s) creation. Input frames with same DIT are stacked together and clean mean is computed for each stack.

### 6.2.3 Master Spatial Flat and bad pixel determination

Recipe: `sinfo_rec_mflat`

Purpose: Generates a master flat field

Clean mean is computed for both on and off-frames, and off-frame is subtracted. Bad pixels are interpolated and the intensity of the master flat is normalized.

Additionally a bad pixel map can be generated. Pixels which deviate more than a user given factor from their neighbourhood are flagged bad. Furthermore, clusters of bad pixels can be detected.

### 6.2.4 Detector's distortion and slitlet distances determination

Recipe: `sinfo_rec_distortion`

Purpose 1: detector's distortion determination.

Fiber frames are stacked with different rejection thresholds to determine a fake slitlets-on and a fake slitlets-off frame. Fake off is subtracted from fake on-frame. LAMP\_FLAT frames are combined to determine a master flat and undistorted WAVE\_LAMP frames are used to determine a wavecal solution. Then distortions are determined on the fake on-off frame. Finally the fake on-off frame is distorted and the slitlet distances are determined with a north south test.

Purpose 2: calculating slitlet distances. Each of the 32 continuum slit spectra are fitted by a Gaussian along spatial direction at each row. This determines the position of the slitlets for each row. These positions are averaged for each slitlet, and the distance of each slitlet from the reference is computed.

### 6.2.5 Wavelength solution determination

Recipe: `sinfo_rec_wavecal`

Purpose: generates a wavelength calibration map.

Clean mean is computed for both on- and off-frames and off-frame is subtracted from on-frame. The resulting frame is flatfielded, corrected for bad pixels and distortion, and convolved with a gaussian.

Emission lines are searched by crosscorrelating with synthetic spectrum created from reference line table and approximate dispersion relation. Emission lines at each image column are fitted, and the found lines are stored in an output file.

At each column, a polynomial fit is carried out on the found emission lines. Within each slitlet, polynomial parameters are smoothed and stored in an output file. These smoothed polynomial parameters are used to generate a wavelength calibration map.

Furthermore, it is possible to compute the slitlet positions during wavelength calibration using either a Boltzmann relation or linear slope. However, this is not as robust a method as obtaining slitlet positions from north south test frames.

Note 1: a linearly offset map can be created using higher order polynomials from one wavelength map and the 0th order coefficient from another.

Note 2: wavelength calibration is sensitive to the quality of the bad pixel map. If a "bad" bad pixel map is used, it is very likely the recipe will fail

### 6.2.6 Standard star data reduction

Recipe: `sinfo_rec_jitter`

Purpose: Photometric calibration.

For each object frame the closest sky in time is selected and the pair is stacked. Objnod step is executed on the stacked frames and the resulting wavelength calibrated data cubes are combined. Standard star spectrum is optimally extracted from the cube. Optionally a mag to counts/sec conversion can be determined

### 6.2.7 PSF data reduction

Recipe: `sinfo_rec_jitter`

Purpose: PSF & Strehl analysis.

For each object frame the closest sky in time is selected and the pair is stacked. Image reconstruction is done by collapsing the image columns. The PSF file is generated and Strehl calculated

### 6.2.8 Science observations

Recipe: `sinfo_rec_jitter`

Purpose: Creating a wavelength calibrated data cube from object-sky frames obtained in jittering mode. Instrumental signatures are removed.

For each object frame the closest sky frame in time is selected and the pair is stacked. Objnod step is executed on the stacked frames generating wavelength calibrated data cubes. The resulting cubes are averaged together weighting by the integration times. A mask cube is produced containing the total integration time on each pixel of the result cube.

Additionally, OH sky emission lines can be used to track and correct the instrumental flexure

## Part II

# SINFONI: a detailed description of the instrument

## 7 General description

### 7.1 Observing with Adaptive Optics

The following section describes some basics on adaptive optics and atmospheric turbulences, essentially taken from the NACO user manual. Interested users could extend on the subject starting e.g. with “Adaptive optics in astronomy”, Rodier 1999, Cambridge University Press, or “Introduction to adaptive optics”, Tyson 2000, Bellingham/SPIE.

#### 7.1.1 Atmospheric turbulence

The VLT has a diffraction-limited resolution of  $\lambda/D = 0.057$  arcsec at  $\lambda = 2.2\mu\text{m}$ . But the resolution is severely limited by atmospheric turbulence to  $\lambda/r_0 \approx 1$  arcsec, where  $r_0$  is the Fried parameter. It is directly linked to the strength of the turbulence and depends on the wavelength as  $\lambda^{6/5}$ . For average observing conditions,  $r_0$  is typically 60cm at  $2.2\mu\text{m}$ .

Temperature inhomogeneities in the atmosphere induce temporal and spatial fluctuations in the air refractive index and therefore cause fluctuations in the optical path. This leads to random phase delays that corrugate the wavefront (WF). The path differences are, to a good approximation, achromatic. Only the phase of the WF is chromatic. The correlation time of WF distortions is related to the average wind speed  $V$  in the atmosphere and is typically of the order of  $r_0/V = 60\text{ms}$  at  $2.2\mu\text{m}$  and  $V = 10\text{m/s}$ .

#### 7.1.2 Adaptive Optics

A powerful technique in overcoming the degrading effects of atmospheric turbulence is real-time compensation of the deformation of the WF by adaptive optics (AO, Figure 3).

The wavefront sensor (WFS) measures WF distortions and these measurements are processed by a real-time computer (RTC). The RTC controls a deformable mirror (DM) which compensates the WF distortions. The DM is a continuous thin plate mirror mounted on a set of piezoelectric actuators that push and pull on the back of the mirror.

Because of the significant reduction in the WF distortions by continuous AO correction, it is possible to record near diffraction-limited images with exposure times that are significantly longer than the turbulence correlation time. The residual error from the WF compensation (WF error) directly determines the quality of the formed image. One of the main parameters characterizing this image quality is the Strehl ratio (SR), which corresponds to the amount of light contained in the diffraction-limited core relative to the total flux.

An AO system is a servo-loop system working in closed loop. The DM flattens the incoming WF and the WFS measures the residual WF error.

SINFONI (as well as CRIRES and the VLTI MACAO systems) is using a Curvature WFS. The curvature sensor is designed to measure the WF curvature (as opposed to the WF slope). This is

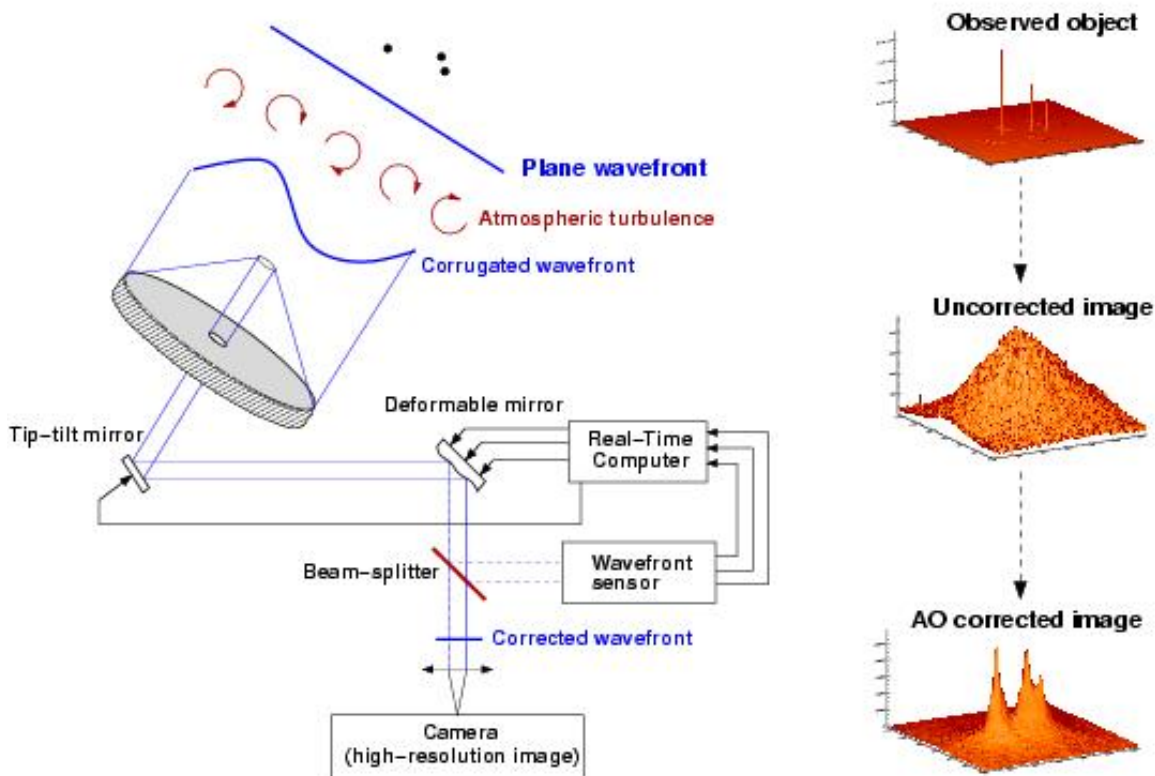

Figure 3: Principle of Adaptive Optics. Note that in practice, and contrary to this schematic design, SINFONI has no dedicated Tip-Tilt mirror, but performs low- and high-order corrections with a single deformable mirror (mounted on a tip-tilt stage).

achieved by comparing the plane irradiance distributions of two planes placed behind and before the focal plane. In practice, a variable curvature mirror (membrane) is placed in the telescope focus. By vibrating, inside and outside focus blurred pupil images can be imaged on a detector array (in SINFONI's case a lenslet array feeding avalanche photo-diodes (APDs)). The modulation frequency of the membrane corresponds to the temporal sampling frequency of the WFS. The difference between the inside and outside pupil image measures the local WF curvature.

The performance of an AO system is directly related to the number of lenslets in the lenslet array, the number of actuators behind the DM, and the rate at which WF errors can be measured, processed and corrected (the server-loop bandwidth).

The performance of an AO system is also directly linked to the observing conditions. The most important parameters are the seeing (or more explicitly  $r_0$  and  $V$ ), the brightness of the reference source used for WFS and the distance between the reference source and the object of interest.

In case of good conditions and a bright, nearby reference source, the correction is good and the resulting point spread function (PSF) is very close to the diffraction limit. A good correction in the K-band typically corresponds to a SR larger than 30%.

At shorter wavelengths (particularly in the J-band) or in the case of poor conditions or a faint, distant reference source, the correction is only partial - the Strehl ratio may only be a few percent.

## 7.2 The Laser Guide Star mode

### 7.2.1 Background information on LGS

Adaptive Optics operations are strongly affected by the size of the isoplanatic angle, usually  $\sim 20''$  at  $2\mu\text{m}$ , but only  $\sim 5''$  (in diameter) at  $0.6\mu\text{m}$ . However, even for observations at  $2.2\mu\text{m}$ , the sky coverage achievable by this technique (equal to the probability of finding a suitable reference star in the isoplanatic patch around the chosen target) is only of the order of 0.5 to 1%. The most promising way to overcome the isoplanatic angle limitation is to use artificial reference stars, or laser guide stars (LGS). Laser Guide Stars are artificial sources, potentially replacing Natural Guide Stars (NGS) as reference objects for Adaptive Optics (AO) image corrections. The rationale is the much higher sky coverage offered in principle by an LGS, as opposed to the standard NGS approach. Due to the bright ( $m \sim 12-13$ ) artificial star created near the centre of the field, the probability to achieve a given minimum AO correction on an arbitrary astronomical target, goes from a meager 3% with an NGS to 65% with an LGS, with a K-band Strehl ratio currently in the 10-20% range.

Nevertheless, there are still a number of physical limitations with a LGS. The first problem is the focus anisoplanatism, also called the Cone Effect. Because the artificial star is created at a relatively low altitude, light collected by the telescope forms a conical beam, which does not cross exactly the same turbulence-layer areas as the light coming from the distant astronomical source. This leads to a phase estimation error. The effect is roughly equivalent to the phase error experienced with a NGS that is  $10''$  away from the astronomical target. Contrary to the case of NGS-only AO, LGS-based corrections are expected to be lower due to the cone effect.

Even more severe is the image motion or tilt determination problem. Because the paths of the light rays are the same on the way up as on the way down, the centroid of the artificial light spot appears to be stationary in the sky, while the apparent position of an astronomical source suffers lateral motions (also known as tip/tilt). The simplest solution is to supplement the AO system using the LGS with a Tip-Tilt Star (TTS), which can be chosen much fainter than an AO star. Performance is then limited by the poor photon statistics for correcting the tip/tilt error. The need of a natural guide star for tip-tilt sensing is the reason why sky coverage cannot go up to 100% for LGS-AO.

Note that, for SINFONI, the LGS VLT system can also be used without TTS starting P82, that is in seeing-enhancer mode (no tip-tilt correction). Although the performances are still being evaluated at the time of updating this manual, we can expect improved image quality *wrt* the no-AO mode.

### 7.2.2 LGS mode at Paranal-UT4

The Laser Guide Star Facility (LGSF) at UT4 is a joint project in which ESO are building the laser room, beam relay and launch telescope while MPE and MPIA provide the laser itself.

The PARSEC project is based on a 4W CW Sodium Laser (589 nm), focused at 90 km altitude in the mesosphere. The thin layer of atomic sodium present at that height produces an  $V \sim 11$  artificial star to guide the AO servo loop. This artificial reference star can be created as close to the astronomical target as desired, and the MACAO visible wavefront sensor is used to correct the high order wavefront aberrations on the target object.

The laser is hosted in a dedicated laboratory under the Nasmyth platform of UT4. A custom-made single mode fibre carries the laser light to the 50cm launch telescope situated on top of the secondary mirror assembly, providing the best possible artificial source image quality. As a safety

measure, a twin whole-sky camera with specialized software is used to monitor incoming aircraft and shut down the beam accordingly.

## 7.3 Observing in the Near-Infrared

### 7.3.1 Atmospheric Transmission

The transmission of the Earth's atmosphere in the J, H and K bands is shown in Fig. 4, the amount of telluric absorption varies with zenith distance and the amount of precipitable water vapour.

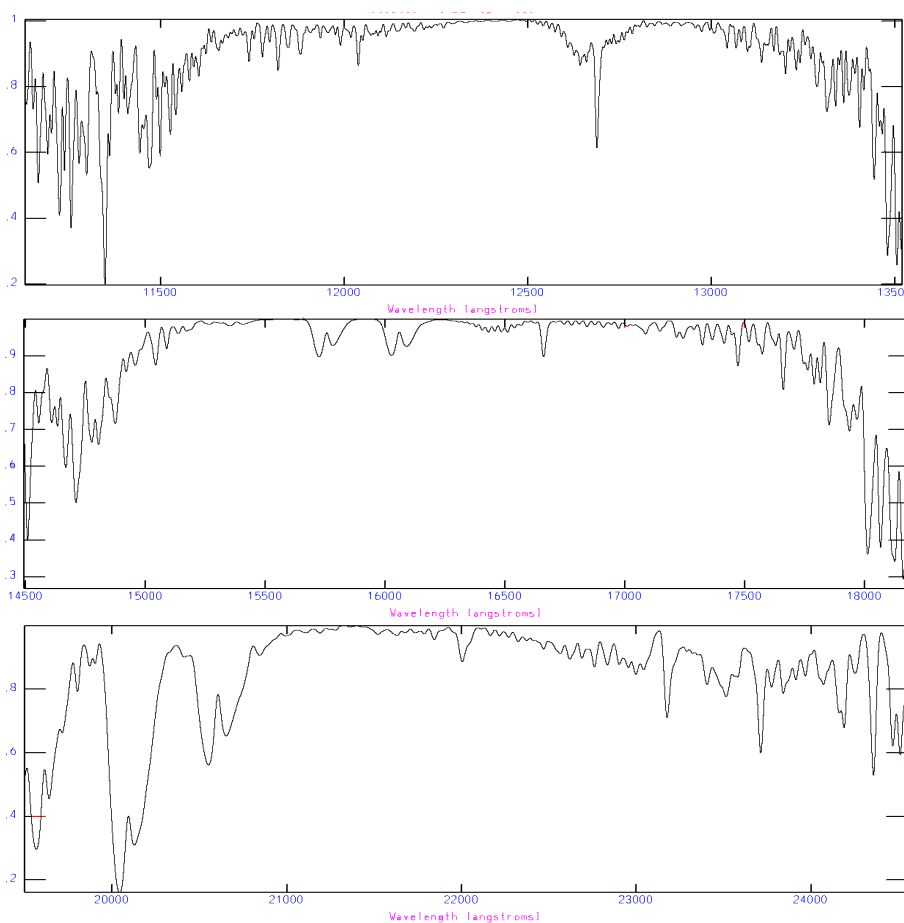

Figure 4: Atmospheric transmission in the J, H and K bands. These graphs are based on FTS data from Kitt Peak, produced by NSF/NOAO.

### 7.3.2 Background Emission

There are two regimes in the sky background emission. Below  $2.2 \mu\text{m}$ , the sky emission is dominated by OH emission, taking place at an altitude of 80 km. Detailed sky spectra with OH line identifications are available on the ISAAC web page. Beyond  $2.2 \mu\text{m}$ , the thermal background dominates. The thermal background consists of atmospheric and telescope emission.

### 7.3.3 Spectrophotometric Calibration

Calibration of spectroscopic data in the IR is a complicated procedure that requires care. It is generally done in three steps. The first step removes telluric features, with what is commonly called a telluric standard; the second step removes the spectral features of the telluric standard that are imprinted onto the science spectrum because of the first step; and the third step sets the absolute scale with what one may call a spectroscopic (flux) standard. In general the spectroscopic standard and the telluric standard are the same star, but this does not need to be the case.

The most prominent features in IR spectra are the telluric lines of the Earth's Atmosphere. Unfortunately, many of the telluric lines do not scale linearly with airmass, so it is necessary to observe a standard at the same airmass and with the same instrument setup as that used for of the science target. Furthermore, the strength of the telluric lines varies with time, so it is also necessary to observe the standard soon after or soon before the science target.

The spectrum of the telluric standard is divided directly into that of the science target. Ideally, the spectrum of the telluric standard should be known, so that features belonging to it can be removed. However, this is not normally the case, so one has to use standards in which the spectrum is approximately known.

In general, we use either hot stars or solar analogs as telluric standards and, generally, these stars are selected from the Hipparcos Catalog. The spectra of hot stars, those hotter than B4, are relatively featureless and are well fit by blackbody curves. So, by knowing the spectral type of the star, one uses a blackbody curve with the appropriate temperature to fit the continuum of the standard. The spectra of stars that are cooler than A0 start to have many more features and cannot be fit with a blackbody curve for wavelengths below 1.6 microns.

Unfortunately, hot stars do contain some features, usually lines of hydrogen and helium, that can be difficult to remove. If the region around the hydrogen and helium lines are of interest, then one can also observe a late type star, which should have weak hydrogen and helium lines. This star is then used to correct for the helium and hydrogen absorption in the spectrum of the hot star. Some hot stars also have emission lines or are in dusty regions. These stars should be avoided. The V-I colour of the star can be used as an indicator of dust. For stars hotter than A0, it should be negative. And lastly, hot stars tend to lie near the galactic plane, so there may be situations where there are no nearby hot stars.

Solar analogs, (for the purpose of removing telluric features) are stars with spectral type G0V to G4V. These standards have many absorption lines in the IR, particularly in the J band. The features can be removed by dividing by the solar spectrum that has been degraded to the resolution of the observations.

In addition to hot stars and solar analogs, IR astronomers have used other stellar types as telluric standards. For example, F dwarfs are commonly used.

We would like users to think carefully about which star is best for their program. Although the observatory will automatically observe a telluric standard for service programs, we cannot guarantee that we will make the best choice, as this depends on the science users wish to do. If you think that a specific spectral type suits your program better than others, we recommend that you submit calibration OBs.

The observatory selects telluric standards from four catalogs: the IRIS Photometric Standards, the MSSSO photometric standards, a composite list of bright spectroscopic standards and the Hipparcos Catalog. The majority of the standards come from the Hipparcos Catalog. Although, the Hipparcos Catalog is an excellent source of telluric standards for ISAAC, most of the stars in the catalog do not have IR magnitudes, which means that IR magnitudes have to be inferred from

the spectral type. Such an extrapolation leads to an uncertainty of 5-20% in the absolute flux calibration. If users wish to have a more certain absolute flux calibration, they should provide their own standards (and should have included these observations in their requested time in Phase 1). Alternatively, if the broad-band magnitudes of the object are known, the absolute flux calibration can be derived by convolving the measured spectrum with the broad-band filter curves. In this case, the IR magnitude of the standard is irrelevant, only the spectral type is important.

## 7.4 Integral Field Spectroscopy

The basic design of any Integral Field Unit (IFU) is a unit which splits the field of view into individual spatial elements (“spaxels”) and recombines them into pseudo longslit(s) which are then passed through a standard spectrometer. The SPIFFI IFU is an image slicing design, which uses a series of mirrors to slice the field of view into 32 sections which make a single pseudo longslit (Fig. 5). Each slice is imaged on 64 detector pixels. Thus, this design provides a square grid of  $32 \times 64$  rectangular spaxels (each  $1/2 \times 1$  the slice width).

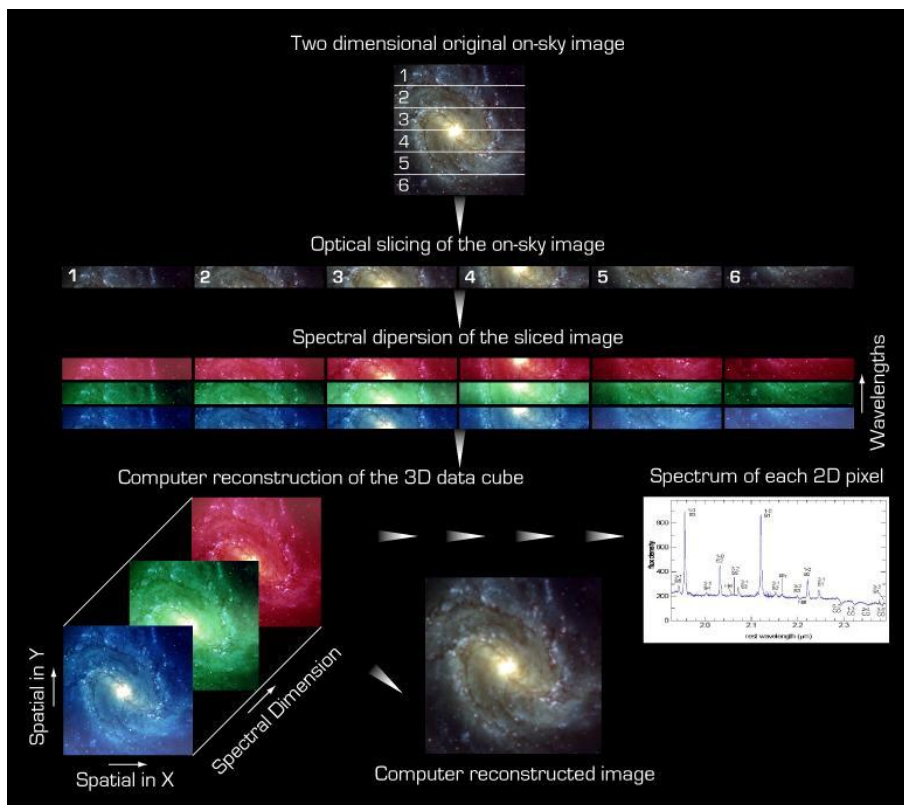

Figure 5: The function of the image slicer. The field of view (top) is slit into small slices which are recombined into a pseudo longslit before being dispersed. The dispersed planes can be recombined to an image, or used to extract spectra at a given point in the field of view.

The main benefits of using an IFU instrument are gained when observing extended objects. There are two typical cases in which IFU observations are much more efficient than those done with a single slit:

- Observing objects which are on a scale similar to that of the field of view: here the benefits are obvious, a single SINFONI observation will be equivalent to  $\approx 32$  single slit observations.

- Smaller objects with an unknown spectral structure: this refers to objects which are smaller than the field of view, but which contain an unobserved spectral structure (e.g. a velocity gradient). With a single slit, several observations would have to be made at different angles to ascertain the spectral structure. With SINFONI, one observation would be all that is needed.

## 8 The Adaptive-Optics Module

### 8.1 AO-Module System Description

#### 8.1.1 The AO Adapter

All the opto-mechanical elements described in this section are mounted to a single Aluminium structure, the AO-adapter, which also provides the mechanical interface to the electronic cabinets and to SPIFFI.

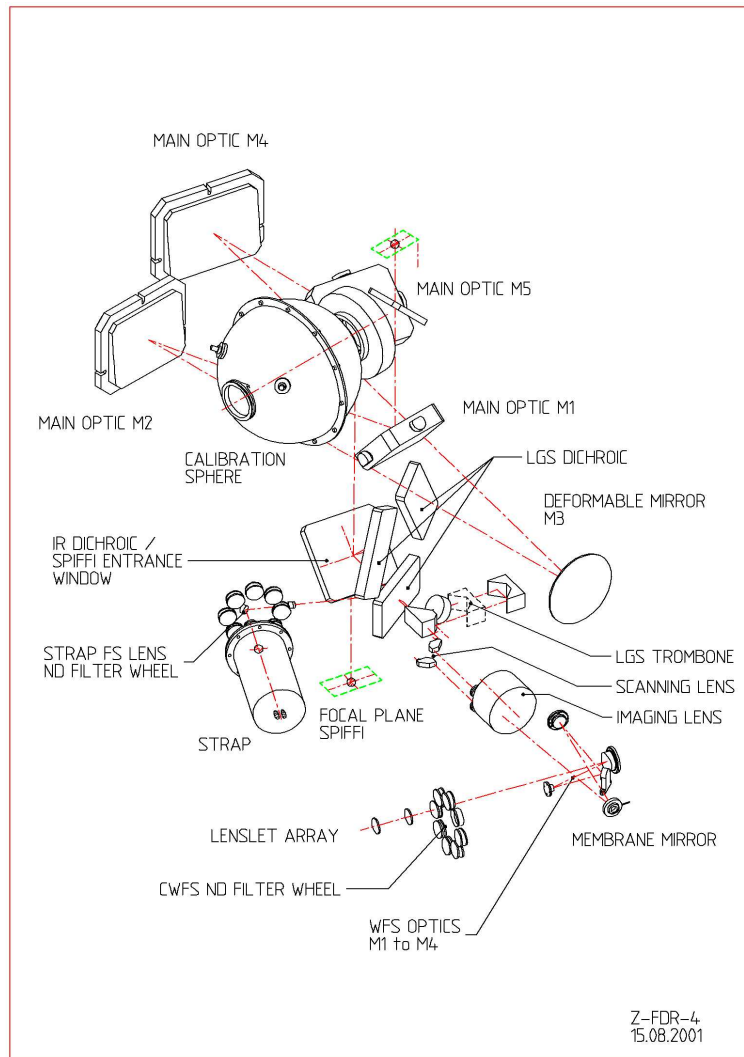

Figure 6: Optical layout of the AO module

#### 8.1.2 The Main Optics

The optical elements of the AO-Module are displayed in Fig. 6.

The input  $f/13.4$  beam is folded by a first flat mirror (M1) and then collimated by an off-axis parabola (M2), creating an image of the pupil on the Deformable Mirror (DM, M3). The output

f/17.1 focus is then created by a second off-axis parabola (M4) and reflected towards the SPIFFI focus by a second folding mirror (M5). Due to tight volume constraint, it has not been possible to find a solution with only one folding mirror, in order to reduce the thermal background contamination of SPIFFI.

Ahead of the SPIFFI focus, an IR Dichroic reflects the visible range (450-950nm) towards the wavefront sensor, while the IR science band (1.05-2.45  $\mu\text{m}$ ) is transmitted to SPIFFI. The dichroic is mounted to SPIFFI and serves also as an entrance window for the cryostat. The  $\sim 750$  mbar pressure difference between the two dichroic surfaces bends the dichroic and induces a small (20nm rms) wavefront error on the reflected wavefront (mainly astigmatism). The image motion on the CWFS caused by outside pressure variations is negligible ( $< 1\text{mas/hr}$ ).

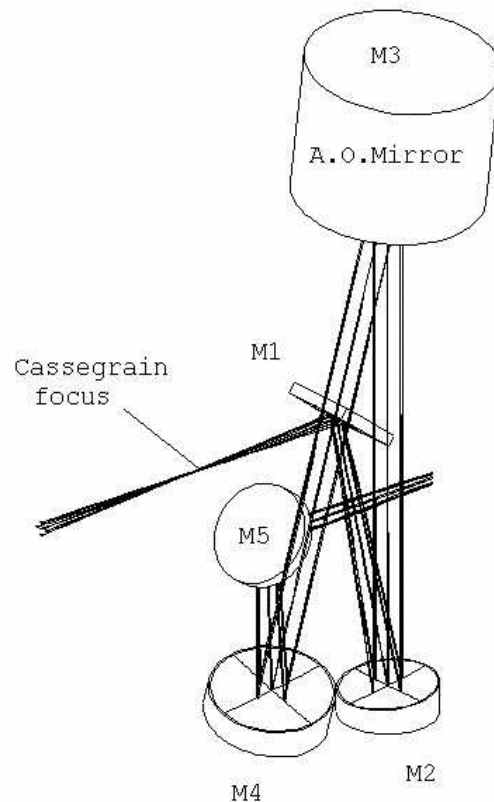

Figure 7: Main optics

### 8.1.3 The Corrective Optics

The wavefront correction is performed by a 60 electrodes bimorph mirror developed by CILAS, with a pupil diameter of 60mm. The 60 electrodes are gold printed and sandwiched between two 0.8mm thick PZT layers with opposite polarisation. The outside surface of the PZT layers are grounded and covered with a 0.1mm glass layer, aluminium coated. Applying a voltage to one electrode produces a constant curvature over its surface of 5km for 1V.

The geometry of the electrodes in the 4 central rings (40 electrodes) matches that of the lenslet array sub-apertures. The 20 remaining electrodes are deposited outside the pupil and are used to constrain the edge of the pupil (correction of curvature free aberrations: tip/tilt, astigmatism...).

The DM provides correction to compensate all atmospheric aberrations up to a seeing of 1 arcsec (measured at 500nm). In addition, the incoming wavefront is also affected by a slower tip/tilt error mainly induced by the telescope, which amplitude exceeds the correcting capability of the DM.

To provide this additional stroke, the DM is mounted to a Tip/Tilt Mount (TTM) designed and built by OBPM, which provides  $\pm 240$  arcsec a mechanical stroke, i.e.  $\pm 3.6$  arcsec on the sky, with a 100Hz -3dB closed loop bandwidth.

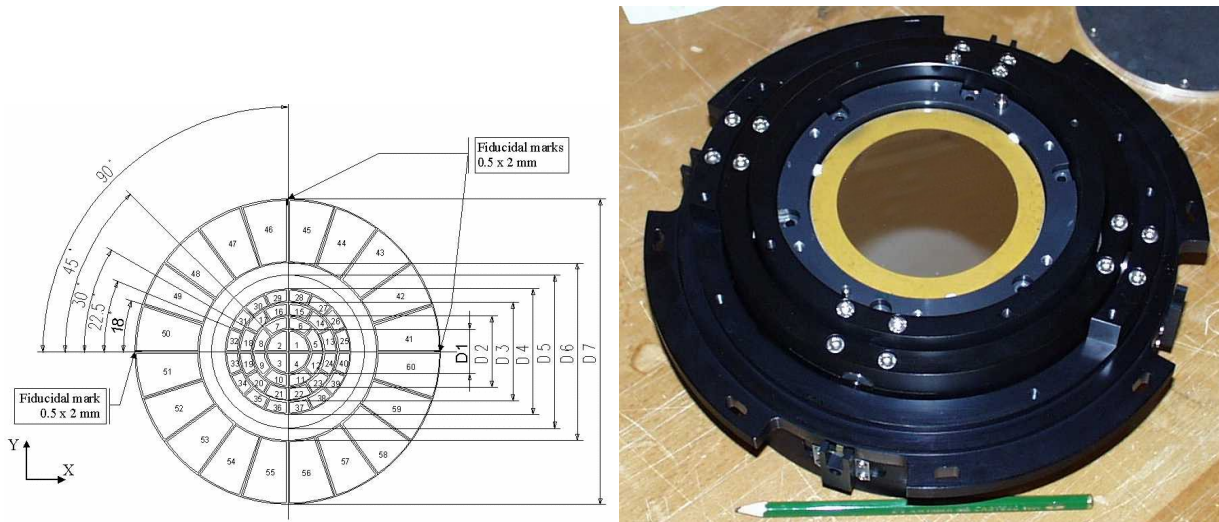

Figure 8: DM electrode geometry – DM/TTM assembly

#### 8.1.4 The Wavefront Sensor

The following functions are sequentially implemented in the wavefront analyzer:

- Extraction of the reference star beam (Field Selector)
- Projection of the reference star image on the Membrane Mirror (Imaging Lens)
- Scan of the intra- and extra-pupil regions by modulation of the Membrane Mirror curvature
- Creation of a pupil image centered on the Lenslet Array.
- Reduction of the flux (for bright reference stars) to within the linear range of the APDs by means of Neutral Densities (NDs) wheel.
- Re-imaging of the 60 sub-pupils on the 60 fiber cores (core diameter:  $100 \mu\text{m}$ ) by the Lenslet Array.
- Injection of the collected beams in the 60 APDs.

The scanning lens of the field selector is mounted on an XYZ table: the XY axes enable the guiding star to be selected in the  $1' \times 2'$  FOV, while the Z stage compensates for the VLT field curvature. The position of the Field Selector defines the reference for the pointing. Since SINFONI is mounted at the Cassegrain focus, the gravity load on the Field Selector is changing with time. As a consequence, the stiffness and accuracy requirements on the linear translators are very stringent. This is also true for the STRAP (see below) Field Selector.

The imaging lens is creating an image of the guiding star on the membrane mirror, which is mounted to an acoustic cavity. A voice coil is mounted to the other end of the cavity, and driven at 2.1kHz by the APD counter module to force an oscillation of the focus mode of the membrane mirror. The incidence angle of the beam on the membrane mirror depends on the position of the guiding star in the field. In order to keep the pupil image (obtained when the membrane mirror is flat) centered on the lenslet array, the membrane mirror is mounted on a 2 axis gimbal, which is co-ordinated with the field selector. A diaphragm in front of the membrane enables the field to be adjusted to the observing conditions (seeing and guiding reference size).

The wavefront sensor box consists of 4 mirrors, which provide a parallel beam to image the pupil on the lenslet array. First, the beam is collimated by a spherical mirror. It is then folded by a flat mirror and injected in the beam expander, which adapts its diameter to the lenslet array (14mm). The Lenslet Array intercepts the beam and divides the flux in 60 sub-aperture. Each sub-pupil is imaged on a fiber, with a 100  $\mu\text{m}$  core diameter. When the membrane mirror vibrates, the pupil image is alternatively projected on both sides of the lenslet array plan. The normalized difference between the intra- and extra-pupil flux collected by each sub-aperture is proportional to the local curvature of the wavefront, which provides the wavefront error signal.

The 60 fibers drive the signal from the Fiber Feed Module to the APD cabinet, mounted to the instrument. The APD counts are recorded by the APD counter module, synchronously with the membrane drive signal.

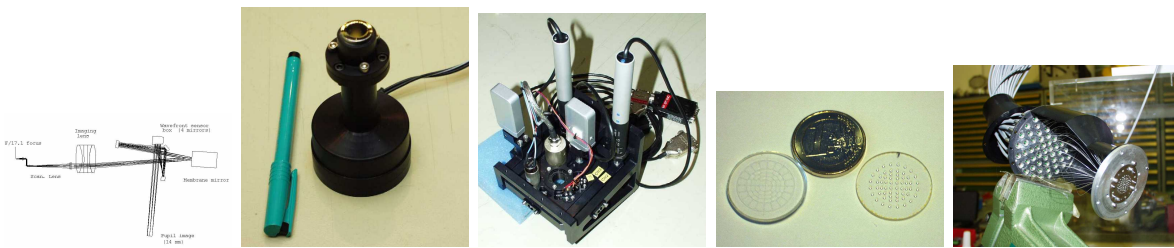

Figure 9: WFS optics – Membrane mirror – Gimbal mount – Lenslet array – Fiber module

### 8.1.5 LGS mode elements

In parallel to the development of the SINFONI AO-Module, ESO develops the Laser Guide Star Facility (LGSF) which will be installed on YEPUN (VLT UT4) with the following main features:

- Launch telescope behind VLT M2
- Continuous sodium wave (589nm)
- Return flux  $10^6$  photons/sec/m<sup>2</sup> at Nasmyth focus (goal  $1.5 \cdot 10^6$ ) for zenith pointing (equivalent to an  $m_V = 11$  F0 star seen through the AO-Module with APDs).
- Altitude of LGS 90km  $\pm$ 10km
- LGS jitter < 50 mas rms
- LGS FWHM < 1.25'' (for zenith angle < 45 deg and seeing < 0.8'' at zenith)

The LGS provides a good wavefront reference for the observation of high order aberrations, but not for the observation of the pointing error, since the atmospheric turbulence also affects the upwards

path of the laser and produces a jitter of the beacon position. In addition to the LGS, a natural guiding star is therefore needed for the tip/tilt control.

The LGS dichroic, inserted in the optical path after the reflection on the IR dichroic, transmits a narrow band centred on the LGS wavelength (589nm) towards the CWFS and reflects the rest of the visible light towards the pointing sensor STRAP.

The differential focus between the LGS and an NGS writes:  $d = \cos z D^2 f^2 / H$ , where  $z$  is the zenith angle (0 to 60 deg),  $D$  the telescope diameter (8m),  $f$  the beam f-number ( $f/17.1$ ) and  $H$  the altitude of the sodium layer (80 to 100km).  $d$  varies between 100 and 250 mm. It is compensated by inserting in the optical path a set of 4 folding mirrors mounted on a translation stage. A second translation stage enables the length of this so called "trombone" to be adjusted to the current conditions. In addition a compensating plate located in the trombone path corrects the astigmatism introduced by the transmission through the LGS dichroic.

Since the differential focus compensation occurs after the main optics relay, the latter is not optimized for the LGS beam, which suffers rather strong field aberrations. The induced Strehl loss remains below 4% in K as long as the LGS is pointed within 5 arcsec of the LOS.

The STRAP unit is mounted on an XY table together with the STRAP lenses, which pick up the guiding star in the  $1' \times 2'$  FOV and images it on the STRAP head.

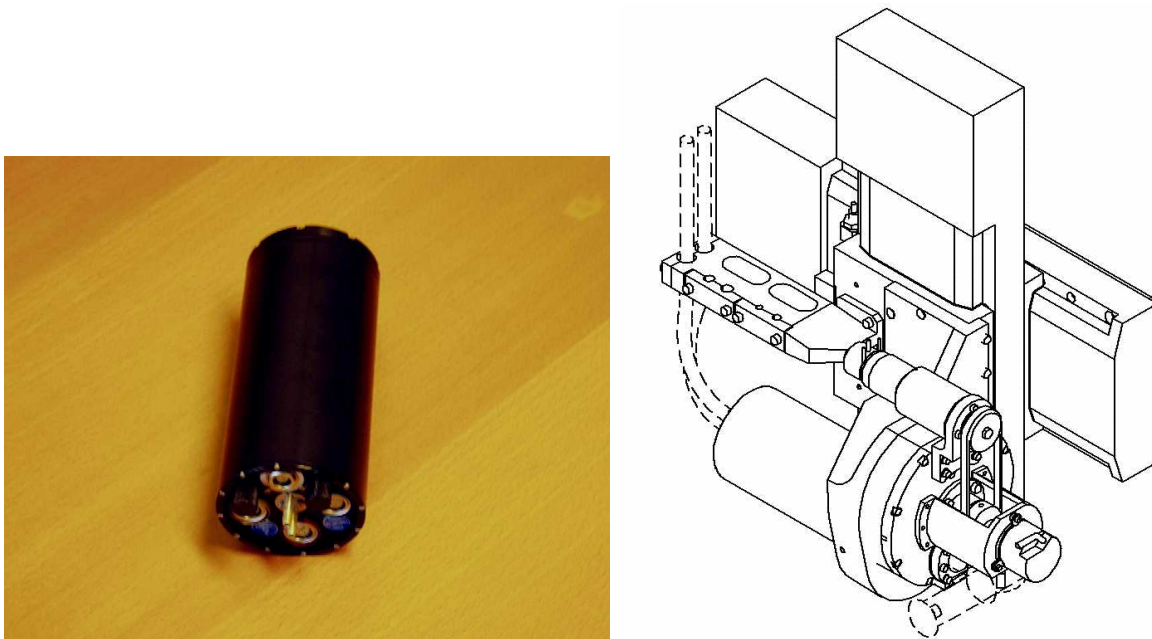

Figure 10: STRAP unit – STRAP assembly

There are two sources of contamination of STRAP by the reflected laser light:

1. on-axis, the LGS itself produces locally a background which can be, in worst case conditions, as bright as 700 times the sky background seen by STRAP in dark conditions, when pointing to zenith;
2. off-axis, the Rayleigh scattering by lower atmospheric layers produces a bright annulus in the focal plane. Its maximum surface brightness can reach 1000 times the dark sky background seen by STRAP, as shown on in Fig. 11.

Since STRAP works in the photon noise regime, it is essential to filter out the laser light background, in order to maximize the limiting magnitude of STRAP and hence the sky coverage. This is achieved

by means of a notch filter, located in front of the STRAP head, blocking the 589nm light and dimming the laser background below the dark sky brightness. In addition, a second filter wheel selects the appropriate Neutral Density Filter, in order to reduce the APD number of counts to within their linear range when observing a bright star.

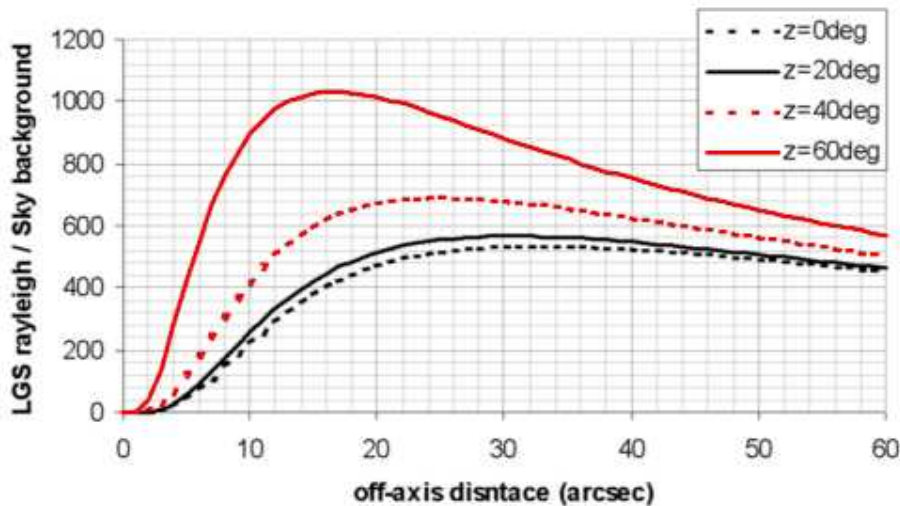

Figure 11: STRAP unit – STRAP assembly

### 8.1.6 Calibration Unit

The Linear Unit Focal plane is used to insert different calibration sources into the optical path. It consists of an X-Y-Z table (3 linear translators) which provides the following functions:

- The Y stage selects the mode of operation:
  - Normal (nothing in the optical path)
  - Flat fielding (flat folding mirror in the optical path)
  - Point source calibration mode (fiber inserted in the path)
- The X and Z table, together with the Y table allow a fine positioning of the point source in the field and along the focus axis. The fiber can be freely positioned in a cube with 25mm edge size around the Cassegrain focal plane.

The Calibration unit consists in an integrating sphere with a 50mm diameter output port, providing a flat field to SPIFFI. In normal operations, a shutter closes the sphere. The integrating sphere provides also two fiber ports. One fiber will be guided from the sphere to the Linear Unit Focal Plane, the other to the LGS trombone for WFS calibration.

The light sources are 4 PenRay lamps (Xenon, Argon, Neon, Krypton) and a halogen lamp with regulated output power. The light sources are mounted in a lamp house. To avoid problems with the excess heat of the lamps the lamp housing is mounted to the AO-Housing. The light is guided to the integrating sphere by a gold-coated tube (50mm diameter).

## 8.2 AO-module System Performances

### 8.2.1 NGS performances

The Strehl performance achieved in NGS mode has been evaluated for on axis observations by combining:

- simulated atmospheric turbulence model together with the measured interaction matrix of SINFONI
- the error budget associated to the instrument (mainly optical aberrations of SPIFFI)
- the resulting Strehl ratios were compared with data taken with SINFONI

The predicted Strehl performance in K band (on-axis) is shown in Fig. 12 for 4 seeing cases (0.6 to 1.2'' at 500nm). For other wavelength bands and in cases where the AO guide star is different to the target an approximate correction factor for the anisoplanatism can be found in table 1.

The main uncertainty in the conversion between optical seeing and IR Strehl ratios is the undefined coherence time of the atmosphere. According to Fig 12 the Strehl ratio at a seeing of 0.8'' may vary between 0.2 and 0.4 for a 14th magnitude AO guide star!

Please note that the exposure time calculator (ETC) should be used in all cases to estimate the feasibility of your science observations based on the latest performance measurements:

<http://www.eso.org/observing/etc>

Exposure time calculator

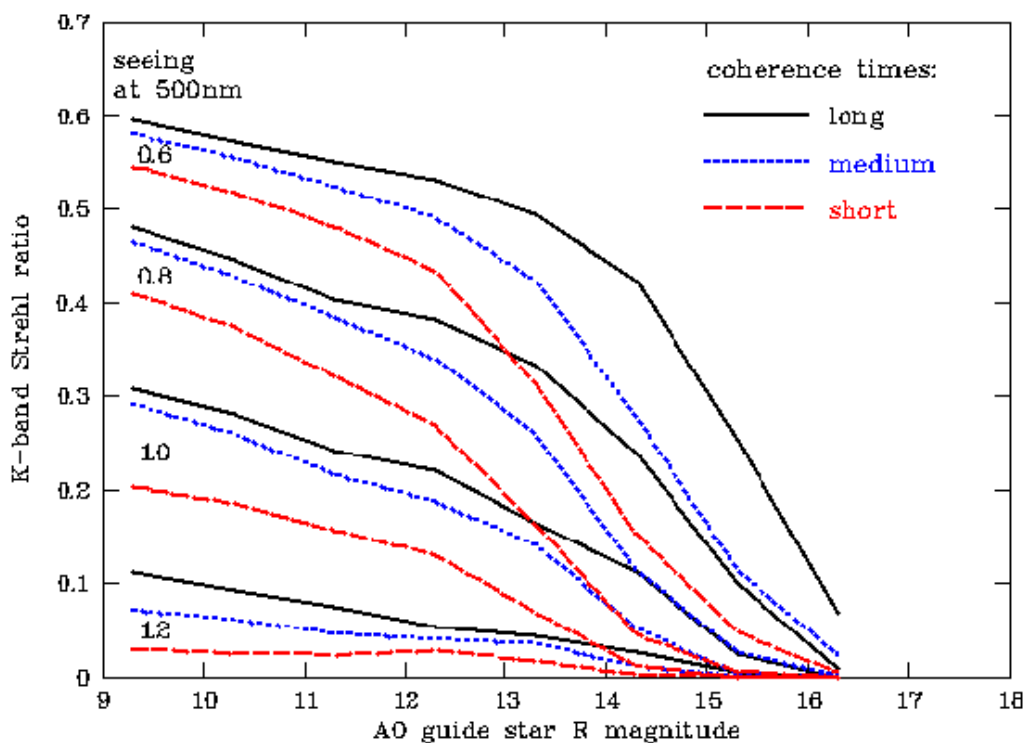

Figure 12: NGS performance for a wide range of optical seeing values (0.6 to 1.2'' ) and long, medium and short coherence times.

Table 1: NGS AO performance: Correction factors for anisoplanatism as function of the distance between target and AO guide star together with the corrections of the Strehl ratios for the respective wavelength bands with respect to the K band on-axis data:

distance	K ( $2.25\mu\text{m}$ )	H+K ( $1.95\mu\text{m}$ )	H ( $1.65\mu\text{m}$ )	J ( $1.25\mu\text{m}$ )
0''	1.00	0.83	0.63	0.31
5''	0.91	0.73	0.52	0.25
10''	0.77	0.60	0.39	0.17
15''	0.54	0.38	0.23	0.08
20''	0.41	0.27	0.15	0.04
25''	0.27	0.17	0.08	0.03
30''	0.21	0.13	0.06	0.02

### 8.2.2 LGS performances

The Strehl performance achieved in LGS mode has been evaluated for on axis observations by combining:

- the performance estimation obtained for the NGS mode with a guide star brightness corresponding to the expected LGS brightness
- the estimated degradation factors undergone in LGS operations:
  - cone effect
  - trombone control error
  - LGS jitter
  - effect of the LGS spot size
  - aberrations introduced by the LGS additional optical elements
  - STRAP performance (depending on the pointing star brightness)
  - tip/tilt anisoplanatism

The **theoretical** Strehl performance in K band is shown in Fig. 13 (for a 0.65 arcsec seeing at 500nm). The **measured** Strehl improvements are currently lower, in the 10% range under median seeing conditions, and up to  $\sim 20\%$  under the best seeing conditions using Tip-Tilt stars with  $R \leq 18$ . Please refer to the ETC (<http://www.eso.org/observing/etc>) to estimate system performances for your particular observations.

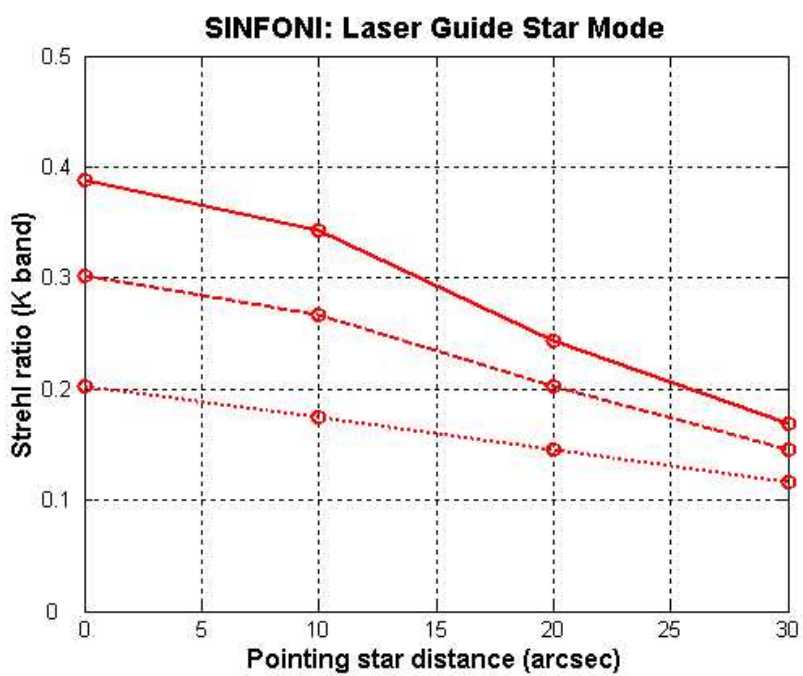

Figure 13: LGS Strehl performance

## 9 The integral field spectrograph SPIFFI

The integral field spectrometer SPIFFI provides simultaneous spectroscopy of  $32 \times 64$  spatial pixels with a spectral resolving power of approximately 3000. Three angular resolution scales are available: When used with the adaptive optics the angular resolution at a wavelength of  $2.2 \mu\text{m}$  is 56 mas (milli-arcseconds) - at a scale of  $12.5 \times 25$  mas/spaxel. To make optimal use of the spatial elements in seeing limited observations - and at partial correction of the atmospheric turbulence with faint reference stars - SPIFFI provides image scales of 100 mas/pixel and 250 mas/pixel. Each of the atmospheric transmission bands J ( $1.1\text{-}1.4 \mu\text{m}$ ), H ( $1.45\text{-}1.85 \mu\text{m}$ ), and K ( $1.95\text{-}2.45 \mu\text{m}$ ) are covered with single exposures. In addition, the combined H and K bands ( $1.45\text{-}2.45 \mu\text{m}$ ) can be observed at a resolution of 1500. With the help of additional mirrors, in a system called the sky-spider, the observer can simultaneously observe the night sky emission from a blank field up to 58 arcseconds off-axis (**not offered yet**). A detailed description of the instrument design can be found in Eisenhauer et al. 2003<sup>2</sup> and Bonnet et al. 2004<sup>3</sup> and references given therein. All components are cooled in a bath cryostat to the temperature of liquid nitrogen. The liquid nitrogen reservoir sits below the instrument plate.

### 9.1 Pre-optics

Below the sky-spider, a doublet lens unit collimates the light onto a cold stop for the suppression of the thermal background. The stop has a diameter of 6 mm, and is equipped with a central obscuration with the equivalent size of the telescope secondary mirror. Just in front of the cold stop is the motorized filter wheel, housing the four band-pass filters, which are required to suppress the unwanted diffraction orders of the gratings. After the cold stop, the motorized optics wheel provides the interchangeable lens systems for the three different image scales, and a pupil-imaging lens for alignment purposes. Each objective consists of two or three lenses. All moving functions are driven by five phase stepper motors, which have been modified for use at cryogenic temperatures.

### 9.2 Image slicer

The focus of the pre-optics is located at the small slicer. This part of the image slicer consists of a stack of 32 plane mirrors, which slices the image into slitlets, and separates the light from each slitlet in different directions. A second set of 32 mirrors, the big slicer, collects the light and forms the pseudo-slit. Figure 15 shows the image slicer. To avoid differential thermal contraction, the unit is completely made from a zero expansion glass. All parts (approximately 70 in number) are optically contacted. No glue is used in the assembly. A detailed description of the design and the manufacturing technique can be found in Tecza et al. (2003, SPIE 4842, 375). Figure 16 indicates the positions of the slitlets on a raw SPIFFI frame, the slitlets run horizontally across the imaging field-of-view and are numbered from top to bottom.

### 9.3 Spectrometer collimator

After the image has been sliced and re-arranged into the pseudo slit, three diamond turned mirrors collimate the light onto the gratings. The first mirror is spherical, and the other two mirrors have

<sup>2</sup>Eisenhauer et al 2003; SPIE 4841, p1686 and astro-ph/0306191

<sup>3</sup>Bonnet et al. 2004; ESO Messenger 117, p17

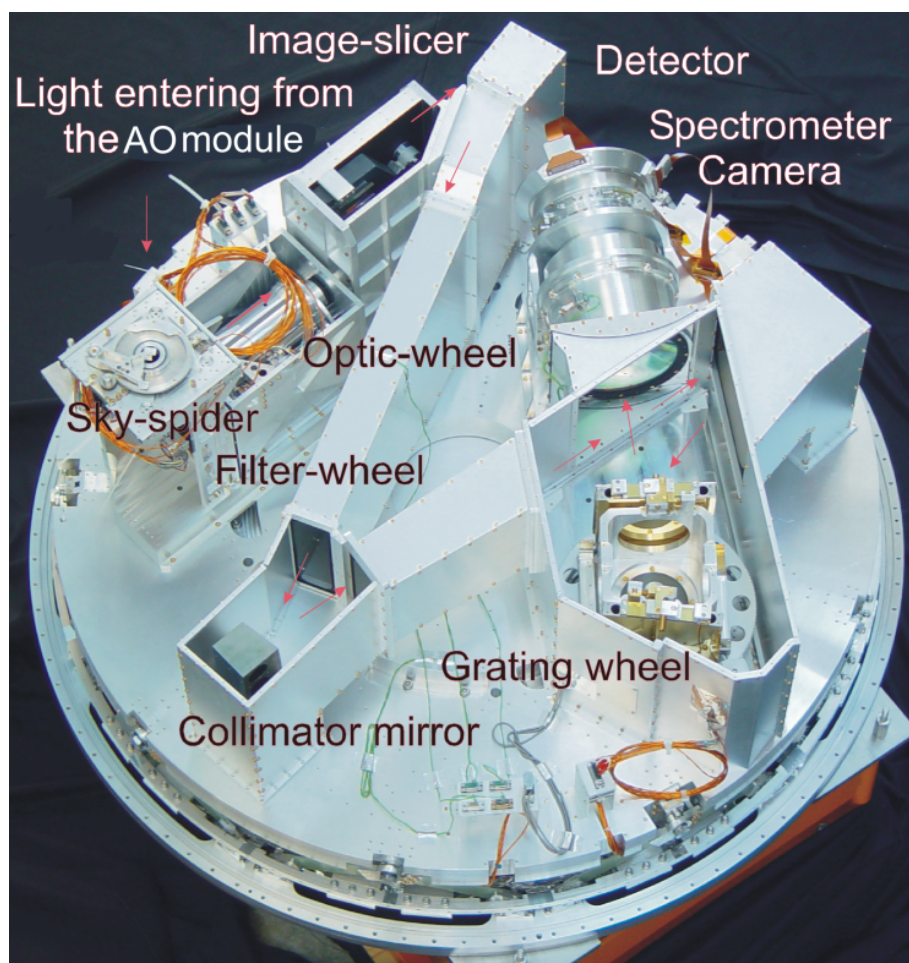

Figure 14: An inside view of SPIFFI: The cryostat cover and the reinforcing structure have been removed to provide a free view on the opto-mechanical components of SPIFFI. The light enters from the top, and passes the sky-spider. The pre-optics with a filter-wheel and interchangeable lenses provides three different image scales. The image slicer re-arranges the two-dimensional field into a pseudo-long slit, which is perpendicular to the base plate. Three diamond turned mirrors collimate the light onto the gratings. In total, four gratings are implemented on the grating drive. A multiple-lens system then focuses the spectra on a Rockwell HAWAII array. The diameter of the instrument is 1.3m.

an oblate elliptical shape. All mirrors are made from Aluminium, with a Nickel layer for the diamond turning process. The mirrors are gold-coated for higher reflectivity.

## 9.4 Grating wheel

In total, SPIFFI has four gratings to cover the J, H, and K atmospheric windows, and the combined H&K band. The gratings are directly ruled in gold on an Aluminium substrate, and every grating is blazed to the centre of its passband. In order to be able to move the spectrum on the detector with an accuracy of  $1/5$  of a pixel, the grating wheel is driven with a 1:647 gear, and controlled via an inductive encoder directly attached to the grating wheel.

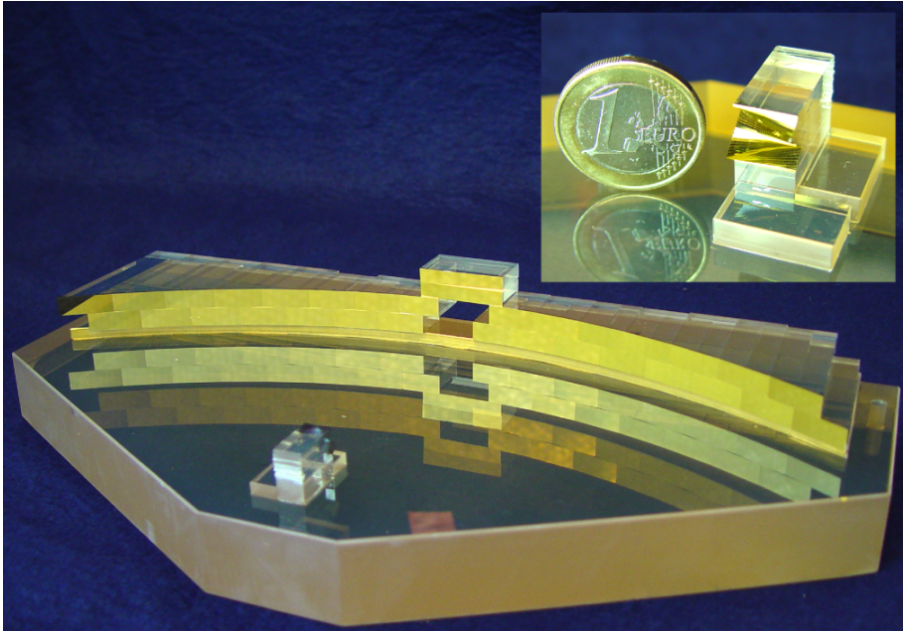

Figure 15: SPIFFI image slicer (a): The light enters through the hole in the big slicer. A stack of 32 small mirrors, the small slicer (also shown in the sub-panel), slices the image and redirects the light towards the 32 mirrors of the big slicer, which re-arranges the slitlets into a 31 cm long pseudo-slit.

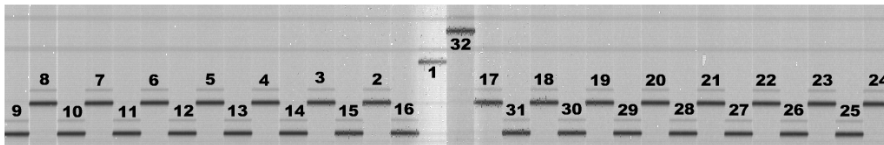

Figure 16: The layout of the slitlets on a raw SPIFFI frame.

grating parameters		
setup	$\lambda_c$	$\lambda$ range
J	$1.25\mu\text{m}$	$1.10 - 1.40\mu\text{m}$
H	$1.65\mu\text{m}$	$1.45 - 1.85\mu\text{m}$
K	$2.20\mu\text{m}$	$1.95 - 2.45\mu\text{m}$
H+K	$1.95\mu\text{m}$	$1.45 - 2.45\mu\text{m}$

## 9.5 Spectrometer camera

SPIFFI is equipped with a Rockwell  $2\text{k} \times 2\text{k}$  pixel Hawaii 2RG array, and a lens spectrometer camera built by a NOVA/MPE/ESO consortium. The camera is a five-lens + 1 folding mirror  $f/D \sim 1/2.8$  design. The diameter of the three big lenses is 170 mm. All lenses have a multi-layer anti-reflection coating optimized for the wavelength range from 1.05-2.45  $\mu\text{m}$ .

## 9.6 Sky-spider

The light enters SPIFFI from the top, and first passes the sky-spider. This device contains three motorized pairs of mirrors, which reflect the light from an off-axis sky field onto the image slicer

field-of-view. The projected distances of the sky-positions from the field centre are 19, 38, and 58 arc-seconds. A fourth position may be used for an upgrade with a coronagraphic mask. See Fig. 17 for the positions of the sky-spider on the SPIFFI field-of-view. (**This mode is not yet offered**)

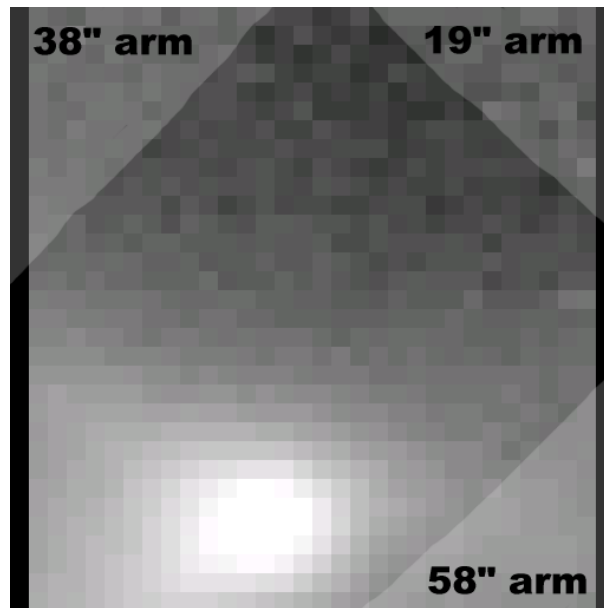

Figure 17: The positions of the sky-spider arms on the SPIFFI FOV. NB: only one arm may be used at a time and its coverage of the field is user selectable.

## 9.7 Detector characteristics

The instrument has been upgraded since February 2005 with a science grade Rockwell Hawaii 2RD detector (2kx2k). The characteristic parameters are summarized below. The detector is permanently read in non-destructive mode. For integration times of  $DIT = 100s$  the noise level is down to  $7 e^-$  - at longer DIT the noise is dominated by Poisson noise from the dark current, thermal background and remnant effects.

Parameter	Detector: Rockwell Hawaii 2RD
Operating Temperature	-189 degrees Celsius
Gain	$2.42 \pm 0.05 e^-/ADU$
Dark current (at -189 deg C)	$0.15 e^-/s$
Noise	RON $16 e^-$ for short DITs; depending on integration time DIT in non-destructive readout mode; down to $7 e^-$ at $DIT \sim 100s$
Linear range (1%)	45000 ADU or 110000 $e^-$
Saturation level	45000 ADU or 110000 $e^-$

**Note:** The detector can show a strong persistence effect, even after being illuminated below the saturation level (typically  $\sim 10k$  ADUs). This is being investigated. Note that if illumination was close or beyond saturation, the time scale to recover from the persistence is longer than an observing night!

## 10 Software Overview

Figure 18 shows the MACAO Software, the external modules with which it interfaces and the overall context in which it operates. In normal operation MACAO is used in conjunction with the SPIFFI instrument and is co-ordinated by the SINFONI SOS.

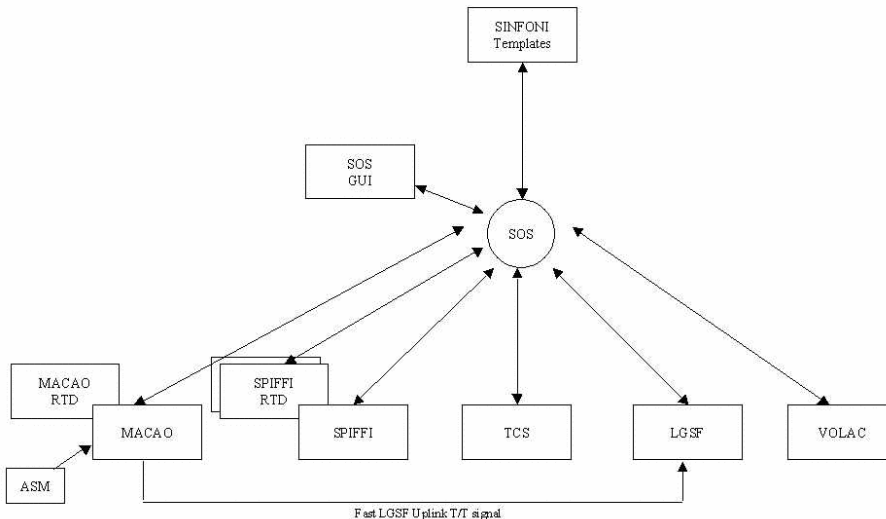

Figure 18: SINFONI software overview

The functions of the software entities shown in the diagram are:

- SINFONI SOS (Supervisor Observing Software): This module is used to coordinate the activity of MACAO with the other sub-systems required to perform a SINFONI observation. These sub-systems are:
  - TCS Telescope Control Software
  - LGSF Laser Guide Star Facility
  - MACAO MACAO AO System
  - SPIFFI Instrument and its RTD
  - ASM Atmospheric Site Monitor
  - VOLAC VLT Online Archive Client

In normal operation MACAO is coordinated by the SINFONI-SOS driven from templates scheduled by BOB or from the SOS GUI, however a stand-alone mode of operation is also provided for AIT in which MACAO can be operated without SPIFFI or the SINFONI SOS.

The SOS performs the set-up of all of the sub-systems required for a particular SINFONI exposure depending upon the instrument mode, starts the exposure, and monitors the status of the exposure, finally archiving the science data using VOLAC.

- TCS (Telescope Control Software): The TCS provides the interface by which MACAO can off-load high stroke Tip/Tilt and Focus errors to the telescope. In normal operation all communication with the TCS is via the SOS.

- LGSF (Laser Guide Star Facility): The LGSF controls the laser generation and up-link, allowing the SOS to request a laser spot to be projected at a particular location. A fast Tip/Tilt signal is fed directly from MACAO to the LGSF to control laser jitter. The LGSF provides the information required for the initial setting of the differential focus trombone and may be the source of the focus offset used to control the focus trombone during observation.
- SPIFFI The SPIFFI instrument S/W is responsible for performing a single observation, returning a completed FITS file to the SOS.
- ASM (Atmospherical Site Monitor) The ASM is used to retrieve the current atmospheric parameters for use in compensating for transversal atmospheric dispersion.
- VOLAC (VLT Online Archive Client) VOLAC implements the interface to the VLT archive system by which clients can request the archival of science product.

## Part III

# Reference Material

## 11 The SINFONI scientific calibration plan

The calibration plan defines the default calibrations obtained and archived by the Paranal Science Operations without being explicitly requested by the service or visitor mode users. We provide here a brief overview.

### 11.1 The science calibrations in a nutshell

<b>SINFONI calibration plan</b>			
Calibration	# of exposures	frequency	purpose
Dark	3	daily	to create master dark frame, bad pixel map
Wavelength calibration	1 on/off pair	daily	to compute wavelength calibration
Lamp flat-field	5 on/off pairs	daily	to determine pixel to pixel variations and large scale illumination
Twilight flat-field	—	—	twilight flat-fields are not possible
Telluric standard	1/observation	daily	to remove telluric features from the science exposures
Detector characteristics	> 10 on/off	monthly	series of flat-fields with increasing intensity, to determine read-out noise, gain, detector linearity, bad pixel map
Distortion data	> 70	monthly	series of images of the calibration fiber while moved in y-direction over the image slicer
<b>not within the SINFONI calibration plan -on user request only!</b>			
AO guide star image	1 object/sky	on request	to determine image quality on axis
PSF standard	n	on request	to determine instrumental/AO PSF
Flux standard	n	on request	to determine overall system transmission - the telluric standards of known magnitudes may be used.

n: number determined by user

## 12 SINFONI template reference

All scientific and calibration observations with ESO instruments are prepared as observing blocks (OBs) with the phase 2 proposal preparation tool (P2PP). The scheduling of these OBs is then done on the site with the broker of observing block (BOB) and p2pp in visitor mode and with bob and the observation tool (OT) during service mode observation runs.

Observing blocks consist of the target information, a small number of user selected templates, the constraints sets and the scheduling informations. The observing templates which are described below are lists of keywords (parameters of the respective templates) to define the configuration and setup to be used for the respective observations.

Parameters can be either selectable by users or they are hidden to the user to compact and to simplify the appearance of the parameter lists. Hidden parameters cannot be changed by the users but only by the instrument operators. Since the hidden parameters will be rarely changed during science observation runs we do not provide an explanation here in the template reference section.

Unlike for other instruments there are only a few templates available for SINFONI. There exists only the integral field spectroscopy (IFS) observation mode. You will find below the list of templates together with the short description of the functionalities.

acquisition templates	functionality	comment
SINFONI_ifs_acq_NGS	Interactive Natural Guide Star Acquisition	recommended
SINFONI_ifs_acq_NGSrrm	Interactive Natural Guide Star Acquisition in RRM mode	recommended
SINFONI_ifs_acq_NGSfast	Fast Natural Guide Star Acquisition	For bright targets only
SINFONI_ifs_acq_LGS	LGS and/or TTS Acquisition	recommended
SINFONI_ifs_acq_noAO	Open loop acquisition	recommended
SINFONI_ifs_acq_noAOrrm	Open loop acquisition in RRM mode	recommended
science templates		
SINFONI_ifs_obs_FixedSkyOffset	IFS with jitter and nodding, fixed sky	recommended
SINFONI_ifs_obs_GenericOffset	IFS with user defined offsets	recommended
SINFONI_ifs_obs_AutoJitterSpider	IFS with jitter and sky spider	not supported
SINFONI_ifs_obs_AutoJitter	IFS with jitter only (no sky offsets)	
night time calibration templates		
SINFONI_ifs_cal_StandardStar	Standard star calibration observation	calibration plan
SINFONI_ifs_cal_PSF	PSF calibration star observation	
SINFONI_ifs_cal_NGS	PSF calibration star observation	
SINFONI_ifs_cal_ArcsAtt	Attached wavelength calibration	
SINFONI_ifs_cal_LampFlatsAtt	Attached lamp flat calibration	
day time calibration templates		
SINFONI_ifs_cal_Arcs	Internal wavelength calibration	calibration plan
SINFONI_ifs_cal_LampFlats	Lamp Flats day time calibration	calibration plan
SINFONI_ifs_cal_Darks	Darks calibration	calibration plan

Most users can prepare the complete observation runs with the 7 templates which are marked as

“recommended”. The calibration templates marked as “calibration plan” are executed by the observatory staff without being specifically requested during the phase 2 observation preparation. The observatory will guarantee that these basic calibration observations are taken within the framework of the calibration plan.

A typical observation block with natural guide star adaptive optics in a normal field would consist of the following templates:

```
SINFONI_ifs_acq_NGS          natural guide star acquisition
SINFONI_ifs_obs_FixedSkyOffset  IFS with jitter and nodding to a selected sky field
```

A typical observation block in open loop (no AO) in a very crowded field would consist of the following templates:

```
SINFONI_ifs_acq_noAO        natural guide star acquisition
SINFONI_ifs_obs_GenericOffset  IFS with nodding to selected sky field(s)
```

It should in most cases be possible to prepare the science OBs with a combination of these 7 ‘recommended’ templates. You may need the other templates in the case that special night time standards or calibrations are requested. Night time arcs and flats are typically not needed even though they are offered for the time being.

The usual rules for OBs apply: you can include only 1 acquisition template, it can be followed by several science templates, changes to set-up are possible between the science templates, offsets of more than typically a few arcminutes will imply the re-acquisition of the telescope guide star, i.e. produce a large overhead.

## 12.1 Acquisition Templates

Unlike for other instruments there is no imaging mode available. All data is taken in the format of an integral field spectrograph - the slices sorted in x-direction and the light dispersed in y-direction on the detector. Interactive acquisition procedures are done on the reconstructed images. These images are calculated within seconds in real time on the instrument control workstations.

There are three acquisition templates offered for SINFONI: The very interactive SINFONI\_ifs\_acq\_NGS will center the natural guide star (NGS) first in open and then in closed loop in the field of view of the widest 250mas scale (SPAXEL size). Then a final centering of the NGS and the target will be done on the user selected scale. In case of the SINFONI\_ifs\_acq\_NGSfast template the interactive steps on the wide 250mas scale are skipped to allow the acquisition of bright NGS ( $K < \sim 6$  mag) without saturating the detector array. The centering of the NGS is done on the smaller user defined scale. Accordingly the coordinates of the NGS and the target must be more accurately known than for the normal target acquisition procedure. The SINFONI\_ifs\_acq\_noAO template will interactively center the target (or a reference star in blind “end offset” mode) in noAO open loop mode.

The main function of the acquisition template is to preset the telescope, to setup the instrument and to move the target to the center of the field of view. The latter is done by an interactive target identification loop on the reconstructed images. Furthermore the acquisition sequence will start the adaptive optics in closed loop mode (NGS templates) or flatten the deformable mirror which is required to achieve excellent image quality in open loop mode (noAO template). The deformable mirror is flattened with the light from the calibration fiber. Unlike for other instrument there are no data stored and archived on the disk during the target acquisition sequence. The detector is

continuously read to save the data acquisition overheads. Optionally a sky subtraction frame can be stored (not being saved to disk) in an offset field for faint targets. The open loop “noAO” acquisition template also offers the option to execute a “blind end offset” from a reference star to the science target.

Here we describe the template keywords common to all target acquisition templates, whereas the more specific keyword parameters are describe later together with the respective template where they are used:

**DIT and NDIR** are the user defined Detector Integration Time and the number of DITs to be integrated before writing the data to the disk. The science templates which involve nodding to sky allow different values of NDIR for target and sky, respectively: NDIR(OBJECT) and NDIR(SKY).

**SPAXEL size and Instrument setup name** define the SINFONI instrument setup. The SINFONI spatial elements (spaxels) on the sky are not square, but rectangular. The “Spaxel size” is the width of one of the 32 image slices (0.025, 0.1 and 0.25 arcsecs) on the sky. Each slice is projected onto 64 pixels by the SINFONI collimator and camera optics, so that the final spatial element measures “Spaxel size”  $\times 1/2 \cdot$  “Spaxel size” (e.g. 250mas $\times$ 125mas). The “instrument setup name” is a symbolic name for the setup required to center the J, H, K and H+K spectra on the detector. The respective setups include the selection of the grating, grating angle, spectral order and order sorting filters.

**The SkySpider Position** should be left in the “ref” erence position, since there is no conclusion yet about how the spectra of the off-axis periscopic sky spiders can be matched with the on-axis target field. The option has been left selectable for further test observations (until further notice).

**RA, DEC, Equinox and Position angle on the sky** define the respective celestial target coordinates. The position angle on the sky is given in the standard astronomical convention ( $N = 0$ ,  $NE = 45$ ,  $E = 90$ , ... in degrees). Note that for  $PA=0$  (North up, East left), the slitlets are oriented East-West, i.e. you will coarsely sample the field in the North-South direction (250,100,25 mas per spaxel) and obtain a finer sampling of the field in East-West direction (125,50,12.5 mas per spaxel). Also, for  $PA=0$  the slitlet number 1 will lie at the top of the detector (high y).

**Differential tracking** is only available for the telescope. There is no differential tracking between the natural guide star and the target. Accordingly the adaptive optics loop can be only closed on the moving target and not on background stars. The value is to be given in units of arcseconds/s. For service mode observations, an ephemerides file needs to be provided. Please consult the P2PP manual concerning the format and submission procedure.

**Telescope guide stars** are either selected from the “CATALOG”s available at the telescope, or selected by the users if the option “SETUPFILE” was selected.

**Telescope offset RA, DEC to sky:** These keywords define the position where the sky field is to be observed if set to values “! = 0”. The sky exposure is taken before starting the interactive target identification. If the value is set to = 0, the step is skipped and the overhead time is shortened. It may not be the best choice to skip the sky for faint targets of  $J, H, K, H + K \gg 15$ .

**Please note:** The coordinates of the telescope guide star, the target and the natural guide star of the AO system should be measured in the same consistent coordinate system with an accuracy of a small fraction of the SINFONI field of view. There is nevertheless an option to center the natural guide star within a 1st interactive loop on the widest field of view of SINFONI (8 arcseconds). For bright natural guide stars (NGS) the AO system will detect in closed loop the small offsets of the NGS and correct it with a tip tilt movement of the deformable mirror.

### 12.1.1 SINFONI\_ifs\_acq\_NGS

Within the interactive natural guide star acquisition sequence the 1st step is to center the NGS in the field of view of the 250mas spaxel scale (8 arcseconds field of view). In the 2nd step it closes the AO loop and centers the NGS again. In the 3rd step it changes the instrument setup to the user selected SPAXEL size and repeats the interactive centering. A final 4th step of interactive centering of the scientific target is the final step. Some steps can be skipped if the target itself is used as natural guide star or if the 250mas scale was selected for the scientific observations.

For any NGS fainter than 11 magnitudes it is mandatory that the telescope guide star coordinates are given by the users (Telescope Guide Star Selection == SETUPFILE). The reason for this is that inaccuracies ( $\sim 1''$ ) in the telescope and/or AO guide star coordinates cause the target to fall off the small field of view of SINFONI. For brighter targets, we expect to detect a few speckles within the field of view to allow an interactive centering in open loop.

SINFONI_ifs_acq_NGS		Interactive Natural Guide Star Acquisition	
<i>Parameters to be specified:</i>			
Parameter	Range	Default	P2PP Label
TEL.TARG.ALPHA		NODEFAULT	RA
TEL.TARG.DELTA		NODEFAULT	DEC
TEL.TARG.EQUINOX		2000	Equinox
DET.DIT	isf	NODEFAULT	Integration time (DIT)
DET.NDIT	isf	NODEFAULT	Number of Integrations (NDIT)
SEQ.NGS.DIT	isf	NODEFAULT	NGS integration time (DIT)
SEQ.NGS.NDIT	isf	1	NGS number of Integrations (NDIT)
SEQ.NGS.ISTARGET	T F	NODEFAULT	Target = AO Guide Star
SEQ.NGS.ALPHA		NODEFAULT	RA of AO Guide Star
SEQ.NGS.DELTA		NODEFAULT	DEC of AO Guide Star
SEQ.NGS.MAG	-2..25	12	R mag of AO Guide Star
SEQ.NGS.COLOR	-1..5	NODEFAULT	NGS B-R color
SEQ.NGS.FWHM	0..10	0.0	FWHM of AO Guide Star (arcsec)
TEL.ROT.OFFANGLE	-235..235	0.0	Position angle on the sky
TEL.TARG.ADDVELALPHA	-15..15	0.0	Differential tracking in RA
TEL.TARG.ADDVELDELTA	-15..15	0.0	Differential tracking in DEC
TEL.AG.GUIDESTAR	NONE SETUP- FILE CATA- LOGUE	CATALOGUE	Telescope guide star selection
TEL.GS1.ALPHA		0.0	RA of telescope guide star
TEL.GS1.DELTA		0.0	DEC of telescope guide star
TEL.SKY.OFFALPHA	-120..120	0.0	Telescope offset RA to sky
TEL.SKY.OFFDELTA	-120..120	30.0	Telescope offset DEC to sky
INS.MIRR1.NAME	isf	Ref	SkySpider Position
INS.OPT11.NAME	isf	NODEFAULT	SPAXEL size (arcsec)
INS.SETUP.NAME	isf	NODEFAULT	Instrument setup name
<i>Hidden parameters:</i>			
SEQ.NGS.ACQSAFE	T F	T	Perform slower safe acquisition
SEQ.NGS.SKYALPHA	-60..60	4.0	WFS Alpha sky offset (arcsec)
SEQ.NGS.SKYDELTA	-60..60	4.0	WFS Delta sky offset (arcsec)
SEQ.NGS.SNR	0.0..10000.0	1000.0	Minimum S/N for AO guide star
SEQ.NGS.USELASTSKY	T F	T	Use for WFS the last measured sky value
SEQ.PRESET	T F	T	Preset flag
DPR.CATG	ACQUISITION	ACQUISITION	Data product category
DPR.TECH	IFU	IFU	Data product technique
DPR.TYPE	OBJECT	OBJECT	Data product type

**Warning:** The full interactive target acquisition with the centering of the NGS on the largest SPAXEL scale would cause saturation and remnance effects on the detector for natural guide stars brighter than 5th magnitude (J,H,K) and 6th magnitude (H+K). Any such event would compromise the data quality of the observations and calibrations taken within the next 12 hours. It is obvious that any such saturation events must be excluded at any time. Please take care!

**NGS parameters:** The parameters for the AO guide star are a logical flag (Science Target = AO Guide Star) and the coordinates of the AO guide star in RA and DEC (for the equinox we presume the value given for the target coordinates). Furthermore the approximate size of the AO guide star (0 for point sources, only specify the size if you expect it to contribute significantly with respect to the seeing) and the approximate magnitude and color of the AO guide star have to be selected. These parameters are required to properly set up the AO system with respect to aperture size of the WFS and differential atmospheric refraction between the visual light WFS and the IR spectrograph.

### 12.1.2 SINFONI\_ifs\_acq\_NGSfast

The NGSfast acquisition template will preset the telescope and setup the instrument to the final instrument scale and spectral range. In a first step the NGS will be centered in open loop using directly the final scale. The second step repeats the acquisition in closed loop. Finally the science target (if different from NGS) can be centered if it is visible in the user selected exposure time.

For most fields the coordinates of the UCAC2 catalog should be accurate enough. The coordinates of the science target and NGS should be also known in the absolute celestial coordinate system in case of a telescope guide star selected from UCAC2.

**Because: (i) this template is reserved for very bright NGS, which would saturate the detector using the normal acquisition template, and (ii) there is a risk of not seeing the target in the small field of view of SINFONI if the coordinates are not known with sufficient accuracy, a waiver submission is required to use this acquisition template in service mode!**

SINFONI_ifs_acq_NGSfast		Fast Natural Guide Star Acquisition	
<i>Parameters to be specified:</i>			
Parameter	Range	Default	P2PP Label
TEL.TARG.ALPHA		NODEFAULT	RA
TEL.TARG.DELTA		NODEFAULT	DEC
TEL.TARG.EQUINOX		2000	Equinox
DET.DIT	isf	NODEFAULT	Integration time (DIT)
DET.NDIT	isf	NODEFAULT	Number of Integrations (NDIT)
SEQ.NGS.DIT	isf	NODEFAULT	NGS integration time (DIT)
SEQ.NGS.ISTARGET	T F	NODEFAULT	Target = AO Guide Star
SEQ.NGS.ALPHA		NODEFAULT	RA of AO Guide Star
SEQ.NGS.DELTA		NODEFAULT	DEC of AO Guide Star
SEQ.NGS.MAG	-2..25	12	R mag of AO Guide Star
SEQ.NGS.COLOR	-1..5	NODEFAULT	NGS B-R color
SEQ.NGS.FWHM	0..10	0.0	FWHM of AO Guide Star (arcsec)
TEL.ROT.OFFANGLE	-235..235	0.0	Position angle on the sky
TEL.TARG.ADDVELALPHA	-15..15	0.0	Differential tracking in RA
TEL.TARG.ADDVELDELTA	-15..15	0.0	Differential tracking in DEC
TEL.AG.GUIDESTAR	NONE SETUP- FILE CATA- LOGUE	CATALOGUE	Telescope guide star selection
TEL.GS1.ALPHA		0.0	RA of telescope guide star
TEL.GS1.DELTA		0.0	DEC of telescope guide star
TEL.SKY.OFFALPHA	-120..120	0.0	Telescope offset RA to sky
TEL.SKY.OFFDELTA	-120..120	30.0	Telescope offset DEC to sky
INS.MIRR1.NAME	isf	Ref	SkySpider Position
INS.OPT11.NAME	isf	NODEFAULT	SPAXEL size (arcsec)
INS.SETUP.NAME	isf	NODEFAULT	Instrument setup name
<i>Hidden parameters:</i>			
SEQ.NGS.NDIT	isf	1	NGS number of Integrations (NDIT)
SEQ.NGS.ACQSAFE	T F	T	Perform slower safe acquisition
SEQ.NGS.SKYALPHA	-60..60	4.0	WFS Alpha sky offset (arcsec)
SEQ.NGS.SKYDELTA	-60..60	4.0	WFS Delta sky offset (arcsec)
SEQ.NGS.SNR	0.0..10000.0	1000.0	Minimum S/N for AO guide star
SEQ.NGS.USELASTSKY	T F	T	Use for WFS the last measured sky value
SEQ.PRESET	T F	T	Preset flag
DPR.CATG	ACQUISITION	ACQUISITION	Data product category
DPR.TECH	IFU	IFU	Data product technique
DPR.TYPE	OBJECT	OBJECT	Data product type

**NGS parameters: (same as interactive acquisition)** The parameters for the AO guide star are a logical flag (Science Target = AO Guide Star) and the coordinates of the AO guide star in RA and DEC (for the equinox we presume the value given for the target coordinates). Furthermore the approximate size of the AO guide star (0 for point sources, only specify the size if you expect it to contribute significantly with respect to the seeing) and the approximate magnitude and color of the AO guide star have to be selected. These parameters are required to properly setup the AO system with respect to aperture size of the WFS and differential atmospheric refraction between the visual light WFS and the IR spectrograph.

### 12.1.3 LGS acquisition template

For the general user, the LGS template is very similar to the NGS template, the only difference being that the Tip-Tilt Star (TTS) is replaced by the AO guide star.

### 12.1.4 SINFONI\_ifs\_acq\_noAO

The open loop (noAO) acquisition template will preset the telescope to the target (or reference star for blind offset acquisitions), setup the instrument to the selected wavelength range and the wide 250mas SPAXEL scale. After the deformable mirror is flattened with the calibration fiber

the interactive target centering is started. First, the target is centered on the 250mas scale and then on the user selected SPAXEL scale. Optionally, a sky frame can be taken in an offset field. The template also provides “blind offsets” capability by offsetting from the reference star to the scientific target.

SINFONI_isf_acq_noAO		Open loop acquisition	
<i>Parameters to be specified:</i>			
Parameter	Range	Default	P2PP Label
TEL.TARG.ALPHA		NODEFAULT	RA
TEL.TARG.DELTA		NODEFAULT	DEC
TEL.TARG.EQUINOX		2000	Equinox
DET.DIT	0..3600	NODEFAULT	Integration time (DIT)
DET.NDIT	isf	NODEFAULT	Number of Integrations (NDIT)
SEQ.FLATTEN	T F	T	Flatten DM using cal unit
TEL.TARG.OFFSETALPHA	-120..120	0.0	Alpha blind offset (arcsec)
TEL.TARG.OFFSETDELTA	-120..120	30.0	Delta blind offset (arcsec)
TEL.ROT.OFFANGLE	-360..360	0.0	Position angle on the sky
TEL.TARG.ADDVELALPHA	-15..15	0.0	Differential tracking in RA
TEL.TARG.ADDVELDELTA	-15..15	0.0	Differential tracking in DEC
TEL.AG.GUIDESTAR	NONE SETUP- FILE CATA- LOGUE	CATALOGUE	Telescope guide star selection
TEL.GS1.ALPHA		0.0	RA of telescope guide star
TEL.GS1.DELTA		0.0	DEC of telescope guide star
TEL.SKY.OFFALPHA	-120..120	0.0	Alpha offset to sky
TEL.SKY.OFFDELTA	-120..120	30.0	Delta offset to sky
INS.MIRR1.NAME	isf	Ref	SkySpider Position
INS.OPT11.NAME	isf	NODEFAULT	SPAXEL size (arcsec)
INS.SETUP.NAME	isf	NODEFAULT	Instrument setup name
<i>Hidden parameters:</i>			
SEQ.PRESET	T F	T	Preset flag
DPR.CATG	ACQUISITION	ACQUISITION	Data product category
DPR.TECH	IFU	IFU	Data product technique
DPR.TYPE	OBJECT	OBJECT	Data product type

**Flatten DM with cal unit?** It is always required to flatten the mirror to achieve a good image quality. The shape of the deformable mirror will change critically with changing gravity vectors. Only standard stars for which the shape of the PSF is irrelevant could be observed without flattening the DM.

**Blind Offsets:** In case of blind offset acquisitions the coordinates of the reference star must be entered into the target package of p2pp. The offsets are defined from the reference star to the target (positive offsets for targets North/East of the reference stars). The relative offset between reference star and target should be accurately known to about a small fraction of the user selected field of view. There is no interactive centering of the science target possible in blind offset mode.

### 12.1.5 RRM acquisition templates

The Rapid Response Mode (RRM) is being offered starting P78, both in “no\_AO” and “NGS” modes. The RRM acquisition templates “SINFONI\_isf\_acq\_noAOrrm” and “SINFONI\_isf\_acq\_NGSrrm” are exactly identical to the “SINFONI\_isf\_acq\_noAO” and “SINFONI\_isf\_acq\_NGS” templates. Only the name has been changed to display the “rrm” suffix.

## 12.2 Science Templates

The four science observing templates provide various strategies for the nodding between object and sky positions and for the jitter offsets between the images taken at the selected object and sky po-

sitions. The recommended template FixedSkyOffset will automatically take exposures in an ABBA sequence with the respective A (object) and B (sky) positions randomly jittered with respect to each other. The GenericOffset template allows to specify any sequence of object and sky positions. The AutoJitter and AutoJitterSpider templates are not nodding between object and sky position. In case of the AutoJitterSpider the sky is taken with a periscope which can be deployed in front of the image slicer into the field of view of the spectrograph. The systematics of this mode is however not yet studied and explored well enough to be supported. The AutoJitter template may be used with large jitter box widths (4" to 7" on the widest 250mas SPAXEL scale with a field of view of 8" . The offsets calculated by the software are in units of full pixels (12.5, 50, 125mas). The jitter offset improves therefore the spatial sampling in y-direction, by offsetting in steps of half of the image slice.

**Note:** All science templates have the hidden parameter *Return to Origin* set to "True", which means that, at the end of the template, the science target returns always to its original position, regardless of the offset sequence used during the template execution.

The common parameters to these templates are described here:

**DIT and NDIT** are the user defined integration time (for the exposures of the target) and the number of DITs to be integrated before writing the data to disk.

**Number of AB or BA cycles:** defines how often the AB cycle is repeated. Set to one, the template will take a AB sequence, set to two, it will take a ABBA sequence (object,sky, sky, object), with three, a ABBAAB sequence. For best sky subtraction the parameter should be set to values of three or larger.

**Number of offset positions:** defines the number of offset positions in case of the GenericOffset and AutoJitter templates.

**Number of exposures per offset:** can be set to values different from 1 in cases where more than one jittered exposure shall be taken at a given on/off position before nodding to the next on/off position. For typical applications, it should be 1 for all templates with ABBA sequences (nodding between object and sky positions).

**SPAXEL size and Instrument setup name** define the SINFONI instrument setup. The "Spaxel size" is the size of the image slice (0.025, 0.1 and 0.25 arcsecs) on the sky. The Spaxel is projected to 2 pixels by the SINFONI collimator and camera optics. The "instrument setup name" is a symbolic name for the setup required to center the J, H, K and H+K spectra on the detector. The respective setups, transparent to the user, include the selection of the grating, grating angle, spectral order and order sorting filters.

**The SkySpider Position** should be left in the "ref" erence position, since there is no conclusion about how the spectra of the off-axis periscopic sky spiders can be matched with the on-axis target field. The option has been left selectable for further test observations only.

**Spectral dither** allows to increase the sampling of the spectra in dispersion direction. If this parameter is selected then the grating is rotated to move the spectra by half a SPAXEL (equivalent to 1 pixel) in dispersion direction. If selected, exposures with both dithered wavelength settings are taken for any object and sky position and for any calibration frame taken at day or night time. The spectral dithering is only supported for visitor mode observations.

**12.2.1 SINFONI\_ifs\_obs\_FixedSkyOffset**

The template moves the telescope alternatively between 'object' and 'sky' positions (nodding). The 'object' positions are randomly distributed (jittered) around the object (initial telescope position) and within a box whose dimensions are set by the parameter "Jitter box width" (in arcsec). The size of the jitter box should be typically between 4 and 32 times the selected SPAXEL size.

The 'sky' positions are also randomly distributed around a fixed offset position (defined by the parameters "Alpha offset to sky" and "Delta offset to sky") from the original (target) telescope position. The box dimension of the random 'sky' positions are also set by the parameter "Jitter box width" around the initial 'sky' position, and therefore identical to those of the target jitter box.

There is an option to change the "Number of exposures per offset position" such that the template takes NEXPO number of jittered exposures before nodding between the object and sky position. This should be rarely needed for the long exposure times of the SINFONI IFS mode observations.

For a given number of AB cycles the exposure time would be:

$$\text{DIT} * \text{NEXPO} * (\text{"NDIT for the object"} + \text{"NDIT for the sky"}) * \text{"Number of AB or BA cycles"}$$

The number of archived exposures will be  $2 * \text{"Number of AB or BA cycles"}$ . One half of these files are taken on the object. These numbers are to be multiplied by the "Number of exposures per offset position" if set to a value different from 1. Twice the number of frames are taken if the spectral dither option is selected.

SINFONI_ifs_obs_FixedSkyOffset		IFS with jitter and nodding	
<i>Parameters to be specified:</i>			
Parameter	Range	Default	P2PP Label
DET.DIT	0..3600	NODEFAULT	Integration time (DIT)
SEQ.JITTER.WIDTH	0..8	NODEFAULT	Jitter box width
SEQ.NABCYCLES	1..100	NODEFAULT	Number of AB or BA cycles
SEQ.NDIT.OBJECT	1..10000	NODEFAULT	NDIT for the OBJECT positions
SEQ.NDIT.SKY	1..10000	NODEFAULT	NDIT for the SKY positions
SEQ.NEXPO	1..1000	1	Number of exposures per offset position
SEQ.SKY.OFFSETALPHA	-3600..3600	NODEFAULT	Alpha offset for Sky
SEQ.SKY.OFFSETDELTA	-3600..3600	NODEFAULT	Delta offset for Sky
SEQ.SPEC DITH	T F	F	Spectral dithering
INS.OPT11.NAME	isf	NODEFAULT	SPAXEL size (arcsec)
INS.SETUP.NAME	isf	NODEFAULT	Instrument setup name
<i>Hidden parameters:</i>			
SEQ.POISSON	1..100	10	
SEQ.RETURN	T F	T	Return to Origin ? (T/F)
DPR.CATG	SCIENCE	SCIENCE	Data product category
DPR.TECH	IFU,NODDING	IFU,NODDING	Data product technique
DPR.TYPE	OBJECT	OBJECT	Data product type

Figure 19 illustrates the execution sequence of the template for the following set of parameters:

Number of AB or BA cycles	4
Jitter box width	~ 6
Alpha offset to sky	~ -20
Delta offset to sky	~ 10
SPAXEL size	0.25

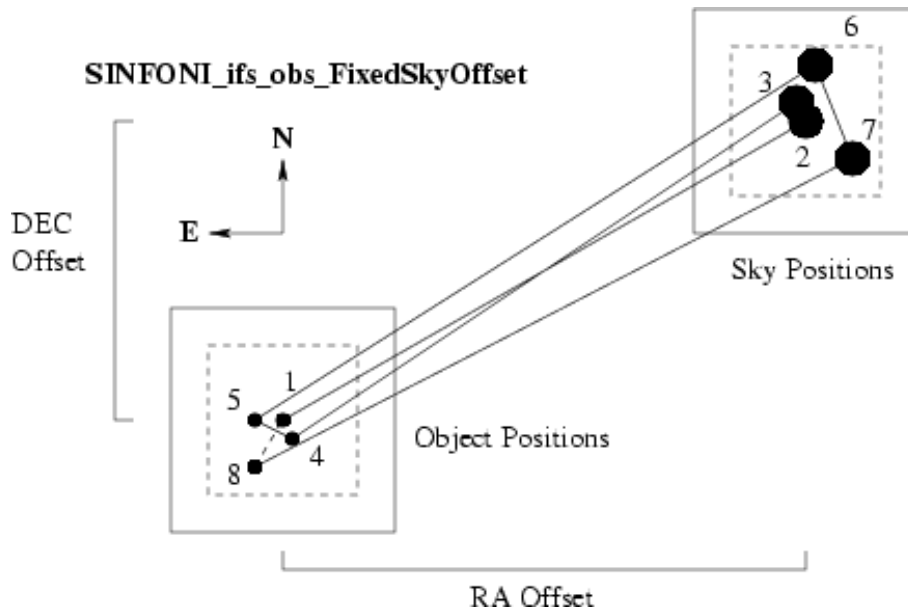

Figure 19: An illustration of the offset sequence taken with the FixedSkyOffset template. (“Number of exposure per Offset” = 1). The large circles for the sky position indicate that these observations are performed in open loop.

### 12.2.2 SINFONI\_ifs\_obs\_GenericOffset

The GenericOffset template has the flexibility to do any sequence of telescope offsets, either in detector or sky coordinates. The sequence of “Object” and “Sky” observations is defined by the user. The number of integration (NDIT) per detector readout can be selected differently for object and sky positions.

The parameter “Offset coordinate type selection” defines if the user selected offsets are executed with respect to the detector XY coordinates or the sky RA,DEC coordinates. The offsets are defined as list of parameters “List of offsets in RA or X” and “List of offsets in DEC or Y” respectively. The offsets are cumulative - relative to the previous position. For a definition of the offset convention, check Fig. 20.

Additionally the observation type and the number of integrations (NDIT) can be defined for any of the object or sky positions in the parameters “List of observation types (O or S)” and “List of number of integrations (NDIT)” respectively. In case of type ‘O’ the archived data files are flagged as “SCIENCE” and the AO loop is closed for NGS AO observations. In case of type ‘S’ the archived files are marked as “SKY” and the loop is opened to allow offsets beyond the range of the field selector mirror which images the science field to the spectrograph image slicer while the NGS is centered on the WFS.

The total number of exposures is defined by the parameter “Number of offset positions”. This number maybe different from the number of elements in the aforementioned lists. Lists do not have to have the same length. If the number of offset exposures is larger than the length of the list, then the list is restarted from the beginning until the correct number of frames have been acquired. The total integration time is DIT times the sum of the NDIT taken at the specified “Number of offset positions” The lists maybe also longer than the “Number of offset positions”, but these offsets will be ignored by the system. It is good practice to use lists of equal length or list which contain only one parameter if one of the parameters shall remain unchanged (like NDIT).

**Warning:** Make sure that you do not have offset positions for type 'O' exposures outside of the range of the field selector.

SINFONI_ifs_obs_GenericOffset		IFS with user defined offsets	
<i>Parameters to be specified:</i>			
Parameter	Range	Default	P2PP Label
DET.DIT	0..3600	NODEFAULT	Integration time (DIT)
DET.NDIT.LIST	isf	NODEFAULT	List of number of integrations (NDIT)
SEQ.NOFF	1..100	NODEFAULT	Number of offset position
SEQ.OBSTYPE.LIST	O S	NODEFAULT	List of observation types (O or S)
SEQ.OFFSET.COORDS	SKY DETECTOR	SKY	Offset coordinate type selection
SEQ.OFFSET1.LIST		NODEFAULT	List of offsets in RA or X
SEQ.OFFSET2.LIST		NODEFAULT	List of offsets in DEC or Y
SEQ.SPECDITH	T F	F	Spectral dithering
INS.OPT11.NAME	isf	NODEFAULT	SPAXEL size (arcsec)
INS.SETUP.NAME	isf	NODEFAULT	Instrument setup name
<i>Hidden parameters:</i>			
SEQ.NEXPO	1..1000	1	Number of exposures per offset position
SEQ.RETURN	T F	T	Return to Origin ? (T/F)
DPR.CATG	SCIENCE	SCIENCE	Data product category
DPR.TECH	IFU,NODDING	IFU,NODDING	Data product technique
DPR.TYPE	OBJECT	OBJECT	Data product type

Figure 20 illustrates the execution sequence of the template for a set of parameters which would simulate some sort of a user defined Jitter pattern without nodding to sky positions. Typically the users should define also type "S" sky positions away from the wide seeing limited wing of the PSF which contains at least 40% of the light!

Offset coordinate type	DETECTOR	SKY
Number of offset positions	8	8
List of observation types	"O"	"O"
List of offsets in X	0 1 0 -1 0 0 -1 0	0 1.4 0 -1.4 0 0 -1.4 0
List of offsets in Y	0 0 2 0 -2 -2 0 2	0 0 2.8 0 -2.8 -2.8 0 2.8
SPAXEL size	0.25	0.25

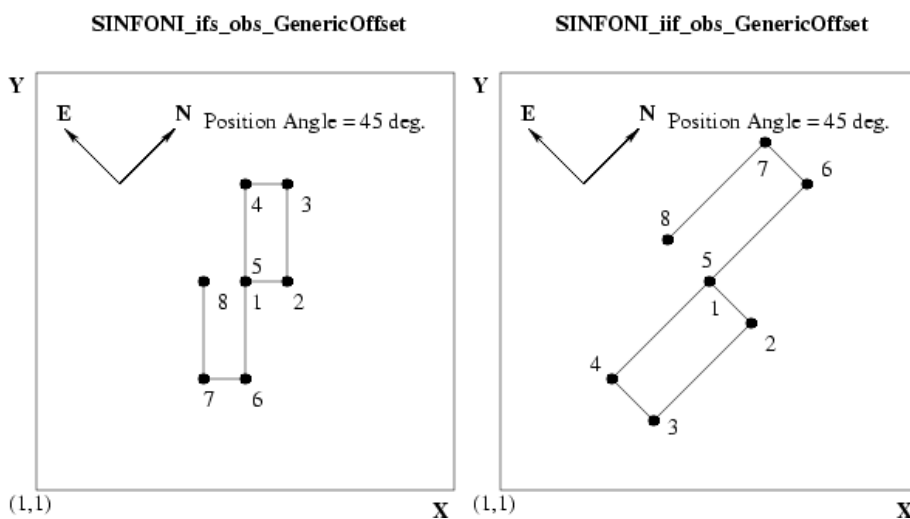

Figure 20: An illustration of the offset sequence taken with the GenericOffset template. Left side: Offset coordinate type "DETECTOR"; Right side: Offset coordinate type "SKY".

### 12.2.3 SINFONI\_ifs\_obs\_AutoJitter

The template offsets the telescope between the exposures (jitter) according to a random pattern automatically determined by the template. It should be only used in the widest field of view of SINFONI. It is only offered on best effort basis since it is well known that even with the AO system the wings of the PSF which contain at least 40% of the light will be distributed to about the seeing limited PSF. It is the user's responsibility to ensure that the sky subtraction is not compromised.

The jitter offsets are distributed within a box whose size is defined by the parameter "Jitter Box Width" (in arcseconds), with the condition that the distance between any two points in a series of ten frames is greater than a certain minimum. This is intentionally done to ensure that the 5 frames before and after any frame are spatially not too close to each other for the sky subtraction. Defining too small jitter box widths (full size of the box) will make a proper sky subtraction difficult, if not impossible. Too large boxes will lead to a poor image overlap. There is no offset executed before taking the first exposure.

The total integration time will be  $DIT * NDIT * \text{"Number of offset positions"}$ .

SINFONI_ifs_obs_AutoJitter		IFS with jitter only (no sky offsets)	
<i>Parameters to be specified:</i>			
Parameter	Range	Default	P2PP Label
DET.DIT	0..3600	NODEFAULT	Integration time (DIT)
DET.NDIT	isf	NODEFAULT	umber of Integrations (NDIT)
SEQ.JITTER.WIDTH	0..8	NODEFAULT	Jitter box width
SEQ.NOFF	1..1000	NODEFAULT	Number of offset positions
SEQ.SPEC DITH	T F	F	Spectral dithering
INS.OPT11.NAME	isf	NODEFAULT	SPAXEL size (arcsec)
INS.SETUP.NAME	isf	NODEFAULT	Instrument setup name
<i>Hidden parameters:</i>			
SEQ.POISSON	1..100	10	
SEQ.RETURN	T F	T	Return to Origin ? (T/F)
SEQ.NEXPO	1..1000	1	Number of exposures per offset position
INS.MIRR1.NAME	isf	Ref	SkySpider Position
DPR.CATG	SCIENCE	SCIENCE	Data product category
DPR.TECH	IFU	IFU	Data product technique
DPR.TYPE	OBJECT	OBJECT	Data product type

Figure 21 illustrates the execution sequence of the template for a relatively small (if not far too small) jitter box of about 2.5 arcseconds on the widest field of view of SINFONI.

### 12.2.4 SINFONI\_ifs\_obs\_AutoJitterSpider

Note that this template is not offered for the time being.

The template is only in one aspect different to the SINFONI\_ifs\_obs\_AutoJitter: It allows to select with the parameter "SkySpider Position" the respective position of the periscopic sky spider mirror in front of the image slicer. The template would mark the acquired data with the flag DPR.TECH like "IFU,SPIDER". Since the template is identical in all other aspects we refer to the AutoJitter template for a description of the parameters.

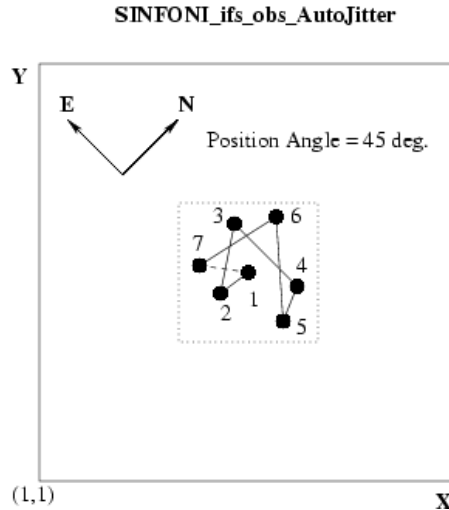

Figure 21: An illustration of the offset sequence taken with the AutoJitter template.

<b>SINFONI_ifs_obs_AutoJitterSpider</b>		<b>IFS with jitter and sky spider</b>	
<i>Parameters to be specified:</i>			
Parameter	Range	Default	P2PP Label
DET.DIT	0..3600	NODEFAULT	Integration time (DIT)
DET.NDIT	isf	NODEFAULT	umber of Integrations (NDIT)
SEQ.JITTER.WIDTH	0..8	NODEFAULT	Jitter box width
SEQ.NEXPO	1..1000	1	Number of exposures per offset position
SEQ.SPEC DITH	T F	F	Spectral dithering
INS.MIRR1.NAME	isf	Ref	SkySpider Position
INS.OPTI1.NAME	isf	NODEFAULT	SPAXEL size (arcsec)
INS.SETUP.NAME	isf	NODEFAULT	Instrument setup name
<i>Hidden parameters:</i>			
SEQ.POISSON	1..100	10	
SEQ.RETURN	T F	T	Return to Origin ? (T/F)
DPR.CATG	SCIENCE	SCIENCE	Data product category
DPR.TECH	IFU,SPIDER	IFU,SPIDER	Data product technique
DPR.TYPE	OBJECT	OBJECT	Data product type

### 12.3 Nighttime Calibration Templates

There are 5 templates available to calibrate during the night. The StandardStar template can be used for any kind of standard star, although mainly to observe telluric standards of known JHK magnitudes to allow the removal of telluric features and to derive an estimate of the instrument response function for the flux calibration of the science data. This template would be typically used by the observatory staff spart of the calibration plan, unless there is a special request for a user selected standard. In that case, the user has to supply his/her own standard using this template. The PSF template is available to obtain an estimate of the instrument PSF by observing a user selected (typically bright) PSF reference star. The StandardStar and PSF templates are identical to the GenericOffset template in keyword content and function. There is furthermore a NGS template offered which will center the natural guide star (NGS) to the center of the image slicer to estimate the PSF by on-axis observations of the NGS. The parameters to be set in the template are DIT, NDIT, and the value of the fixed sky offset. The template is only useful if target and NGS are not identical.

Attached lamp calibrations are also provided. These templates will read the exposure times and lamp setups from a local data base. Accordingly, there is only one parameter left over – the spectral dither flag – which defines whether spectrally dithered calibration should be taken or not.

### 12.3.1 SINFONI\_ifs\_cal\_StandardStar

As mentioned above - this template is almost exclusively used by the staff to take telluric and flux standards close in airmass and time with respect to the science observations (another example of standard stars are velocity standards). Please find the explanation of the parameters within the description of the GenericOffset template.

SINFONI_ifs_cal_StandardStar		Standard star calibration observation	
<i>Parameters to be specified:</i>			
Parameter	Range	Default	P2PP Label
DET.DIT	0..3600	NODEFAULT	Integration time (DIT)
DET.NDIT.LIST	isf	NODEFAULT	List of number of integrations (NDIT)
SEQ.NOFF	1..100	NODEFAULT	Number of offset position
SEQ.OBSTYPE.LIST	O S	NODEFAULT	List of observation types (O or S)
SEQ.OFFSET.COORDS	SKY DETECTOR	SKY	Offset coordinate type selection
SEQ.OFFSET1.LIST		NODEFAULT	List of offsets in RA or X
SEQ.OFFSET2.LIST		NODEFAULT	List of offsets in DEC or Y
SEQ.SPECDITH	T F	F	Spectral dithering
INS.OPTI1.NAME	isf	NODEFAULT	SPAXEL size (arcsec)
INS.SETUP.NAME	isf	NODEFAULT	Instrument setup name
<i>Hidden parameters:</i>			
SEQ.RETURN	T F	T	Return to Origin ? (T/F)
DPR.CATG	CALIB	CALIB	Data product category
DPR.TECH	IFU,NODDING	IFU,NODDING	Data product technique
DPR.TYPE	STD	STD	Data product type

### 12.3.2 SINFONI\_ifs\_cal\_PSF

This template may be used by observers who require special PSF standards. Since the template is identical with the GenericOffset template we will keep the description as short as it can be. It is offered to get properly flagged calibration data frames in the archive. Please find the explanation of the parameters within the description of the GenericOffset template.

SINFONI_ifs_cal_PSF		PSF calibration star observation	
<i>Parameters to be specified:</i>			
Parameter	Range	Default	P2PP Label
DET.DIT	0..3600	NODEFAULT	Integration time (DIT)
DET.NDIT.LIST	isf	NODEFAULT	List of number of integrations (NDIT)
SEQ.NOFF	1..100	NODEFAULT	Number of offset position
SEQ.OBSTYPE.LIST	O S	NODEFAULT	List of observation types (O or S)
SEQ.OFFSET.COORDS	SKY DETECTOR	SKY	Offset coordinate type selection
SEQ.OFFSET1.LIST		NODEFAULT	List of offsets in RA or X
SEQ.OFFSET2.LIST		NODEFAULT	List of offsets in DEC or Y
SEQ.SPECDITH	T F	F	Spectral dithering
INS.OPTI1.NAME	isf	NODEFAULT	SPAXEL size (arcsec)
INS.SETUP.NAME	isf	NODEFAULT	Instrument setup name
<i>Hidden parameters:</i>			
SEQ.RETURN	T F	T	Return to Origin ? (T/F)
DPR.CATG	CALIB	CALIB	Data product category
DPR.TECH	IFU,NODDING	IFU,NODDING	Data product technique
DPR.TYPE	PSF-CALIBRATOR	PSF-CALIBRATOR	Data product type

### 12.3.3 SINFONI\_ifs\_cal\_NGS

The output files of this template are thought to serve as PSF reference data like for the PSF template. Here for the NGS template the data is taken in the field of the science observations with the NGS which was selected for the adaptive optics. The template will setup the field selector mirror and telescope from the target back to the NGS, take the exposure and the sky frame and

setup the field selector mirror back to the science target. The template can be attached to any science exposure which is taken in closed loop.

In the case of **LGS observations**: We recommend the user to insert this template **before** the science template, particularly if the science target is not visible and the NGS (Tip-Tilt Star) image is used to recenter image-cubes obtained at different dates. The LGS observations are more sensitive than NGS observations to changes in the meteo conditions. As a result, the AO loop has a higher probability to crash during long science target observation sequences if the conditions deteriorate. Obtaining the Tip-Tilt Star image before starting the science template secures the reference position to be obtained even in case the science template is later aborted.

Please find the explanation of the parameters within the description of the GenericOffset template.

SINFONI_ifs_cal_NGS		PSF calibration star observation	
<i>Parameters to be specified:</i>			
Parameter	Range	Default	P2PP Label
DET.DIT	0..3600	NODEFAULT	Integration time (DIT)
DET.NDIT.LIST	isf	1 1	List of number of integrations (NDIT)
SEQ.NOFF	1..100	2	Number of offset positions
SEQ.OBSTYPE.LIST	O S	NODEFAULT	List of observation types (O or S)
SEQ.OFFSET.COORDS	SKY DETECTOR	SKY	Offset coordinate type selection
SEQ.OFFSET1.LIST		NODEFAULT	List of offsets in RA or X
SEQ.OFFSET2.LIST		NODEFAULT	List of offsets in DEC or Y
SEQ.SPEC DITH	T F	F	Spectral dithering
INS.OPT1.NAME	isf	NODEFAULT	SPAXEL size (arcsec)
INS.SETUP.NAME	isf	NODEFAULT	Instrument setup name
<i>Hidden parameters:</i>			
SEQ.RETURN	T,F	T	Return to origin ? (T/F)
DPR.CATG	CALIB	CALIB	Data product category
DPR.TECH	IFU,NODDING	IFU,NODDING	Data product technique
DPR.TYPE	PSF-CALIBRATOR	PSF-CALIBRATOR	Data product type

### 12.3.4 SINFONI\_ifs\_cal\_ArcsAtt

This template takes an arc line calibration with whatever setup was selected for the template executed immediately before. All parameters are read from our local data base (except of the spectral dithering flag). There are two exposures taken (4 with spectral dither) - one with the lamps on and the other with the lamps off.

Note that the LampFlatAtt and ArcAtt templates can only be used as the last templates of the OB without losing the AO reference star.

We do not expect that arc lines calibrations will be needed at night time since there a many OH lines in the IR sky which can be nicely used to calibrate medium resolution IR spectra.

SINFONI_ifs_cal_ArcsAtt		Attached wavelength calibration	
<i>Parameters to be specified:</i>			
Parameter	Range	Default	P2PP Label
SEQ.SPEC DITH	T F	F	Spectral dithering
<i>Hidden parameters:</i>			
SEQ.ARC	T F	T	Night Arc ?
SEQ.FLATFIELD	T F	F	Night Flat field ?
DPR.CATG	CALIB	CALIB	Data product category
DPR.TECH	IFU	IFU	Data product technique
DPR.TYPE	WAVE,LAMP	WAVE,LAMP	Data product type

### 12.3.5 SINFONI\_ifs\_cal\_LampFlatsAtt

This template takes an internal lamp flat field with whatever setup was selected for the template executed immediately before. All parameters are read from our local data base (except for the spectral dithering flag). There are two exposures taken (4 with spectral dither) - one with the halogen lamp on and the other with the lamp off.

We do not expect that internal flat fields will be needed at night time since the flexures are small even though not negligible.

SINFONI_ifs_cal_LampFlatsAtt		Attached lamp flat calibration	
<i>Parameters to be specified:</i>			
Parameter	Range	Default	P2PP Label
SEQ.SPECDITH	T F	F	Spectral dithering
<i>Hidden parameters:</i>			
SEQ.ARC	T F	T	Night Arc ?
SEQ.FLATFIELD	T F	F	Night Flat field ?
DPR.CATG	CALIB	CALIB	Data product category
DPR.TECH	IFU	IFU	Data product technique
DPR.TYPE	WAVE,LAMP	FLAT,LAMP	Data product type

## 12.4 Daytime Calibration Templates

The day time calibration observations are typically prepared by the staff astronomers with an automatic tool (calobBuild) which will scan the headers of the frames taken during the nights. Based on this data it will then define and sort the required sequence of calibration exposures according to the SINFONI calibration plan. It is not foreseen that users will use any of the day time calibration templates below. We only present these templates to provide a reference between the data files and the respective templates.

SINFONI_ifs_cal_Arcs		Internal wavelength calibration	
<i>Parameters to be specified:</i>			
Parameter	Range	Default	P2PP Label
DET.DIT	0..3600	NODEFAULT	Integration time (DIT)
DET.NDIT	isf	NODEFAULT	Number of Integrations (NDIT)
SEQ.NEXPO	1..1000	1	Number of exposures per offset position
SEQ.SPECDITH	T F	F	Spectral dithering
INS.LAMP1.ST	T F	NODEFAULT	Xenon lamp status
INS.LAMP2.ST	T F	NODEFAULT	Krypton lamp status
INS.LAMP3.ST	T F	NODEFAULT	Neon lamp status
INS.LAMP4.ST	T F	NODEFAULT	Argon lamp status
INS.OPT11.NAME	isf	NODEFAULT	SPAXEL size (arcsec)
INS.SETUP.NAME	isf	NODEFAULT	Instrument setup name
<i>Hidden parameters:</i>			
DPR.CATG	CALIB	CALIB	Data product category
DPR.TECH	IFU	IFU	Data product technique
DPR.TYPE	WAVE,LAMP	WAVE,LAMP	Data product type

SINFONI_ifs_cal_LampFlats		Lamp Flats day time calibration	
<i>Parameters to be specified:</i>			
Parameter	Range	Default	P2PP Label
DET.DIT	0..3600	NODEFAULT	Integration time (DIT)
DET.NDIT	isf	NODEFAULT	Number of Integrations (NDIT)
SEQ.NEXPO	1..1000	1	Number of exposures per offset position
SEQ.SPECDITH	T F	F	Spectral dithering
INS.LAMP5.VALUE	0..127	NODEFAULT	Halogen lamp value (0..127)
INS.MIRR1.NAME	isf	Ref	SkySpider Position
INS.OPT11.NAME	isf	NODEFAULT	SPAXEL size (arcsec)
INS.SETUP.NAME	isf	NODEFAULT	Instrument setup name
<i>Hidden parameters:</i>			
DPR.CATG	CALIB	CALIB	Data product category
DPR.TECH	IFU	IFU	Data product technique
DPR.TYPE	WAVE,LAMP	FLAT,LAMP	Data product type

<b>SINFONI_ifs_cal_Darks</b>		<b>Darks calibration</b>	
<i>Parameters to be specified:</i>			
<b>Parameter</b>	<b>Range</b>	<b>Default</b>	<b>P2PP Label</b>
DET.DIT	isf	NODEFAULT	Integration time (DIT)
DET.NDIT	isf	NODEFAULT	Number of Integrations (NDIT)
DET.NDITSKIP	isf	NODEFAULT	NDIT to skip
DET.NDSAMPLES	isf	NODEFAULT	Number of samples
DET.NDSKIP	isf	NODEFAULT	Samples skipped per NDIT
SEQ.NEXPO	1..1000	1	Number of exposures per offset position
<i>Hidden parameters: none</i>			
DPR.CATG	CALIB	CALIB	Data product category
DPR.TECH	IMAGE	IMAGE	Data product technique
DPR.TYPE	DARK	DARK	Data product type

## 13 The Spectral Resolution of SINFONI

In this section, we summarize the preliminary measurements of the spectral resolution of SINFONI. Here we refer only to the PSF in spectral direction. The spectral resolution of SINFONI is complicated by the fact that the various pre-optics illuminate the gratings differently. This causes a strong dependence of the spectral resolution on the selected pre-optics.

Below we show spectral PSFs as measured during the SINFONI commissioning (courtesy A. Gilbert from MPE) for all plate-scales in all bands. The profiles were smoothed from super-sampled arc lines (wavelength calibrated and collapsed in the spatial direction).

The spectral resolutions per band and plate-scale, when simply computed from the FWHM of the arc lines are:

Band	Spectral Resolution		
	Spatial Scale		
	250mas	100mas	25mas
J	1870	1800	2360
H	2920	2730	5500
K	4490	5090	5950
H+K	1640	2050	2710

Note, however, that this does not take into account that the lines are not Nyquist sampled in all modes. The averaged FWHM in pixels is:

Band	Resolution in Pixels		
	250	100	25mas
J	4.47	4.64	3.53
H	2.83	3.02	1.50
K	1.96	1.73	1.48
H+K	2.37	1.90	1.44

Thus, for the cases in which the FWHM is less than 2 pixels, the spectral resolution is probably to be computed from a resolution of 2 pixels (dispersion being 0.15; 0.2; 0.25; 0.50 nm/pix for the J; H; K; H+K bands, respectively).

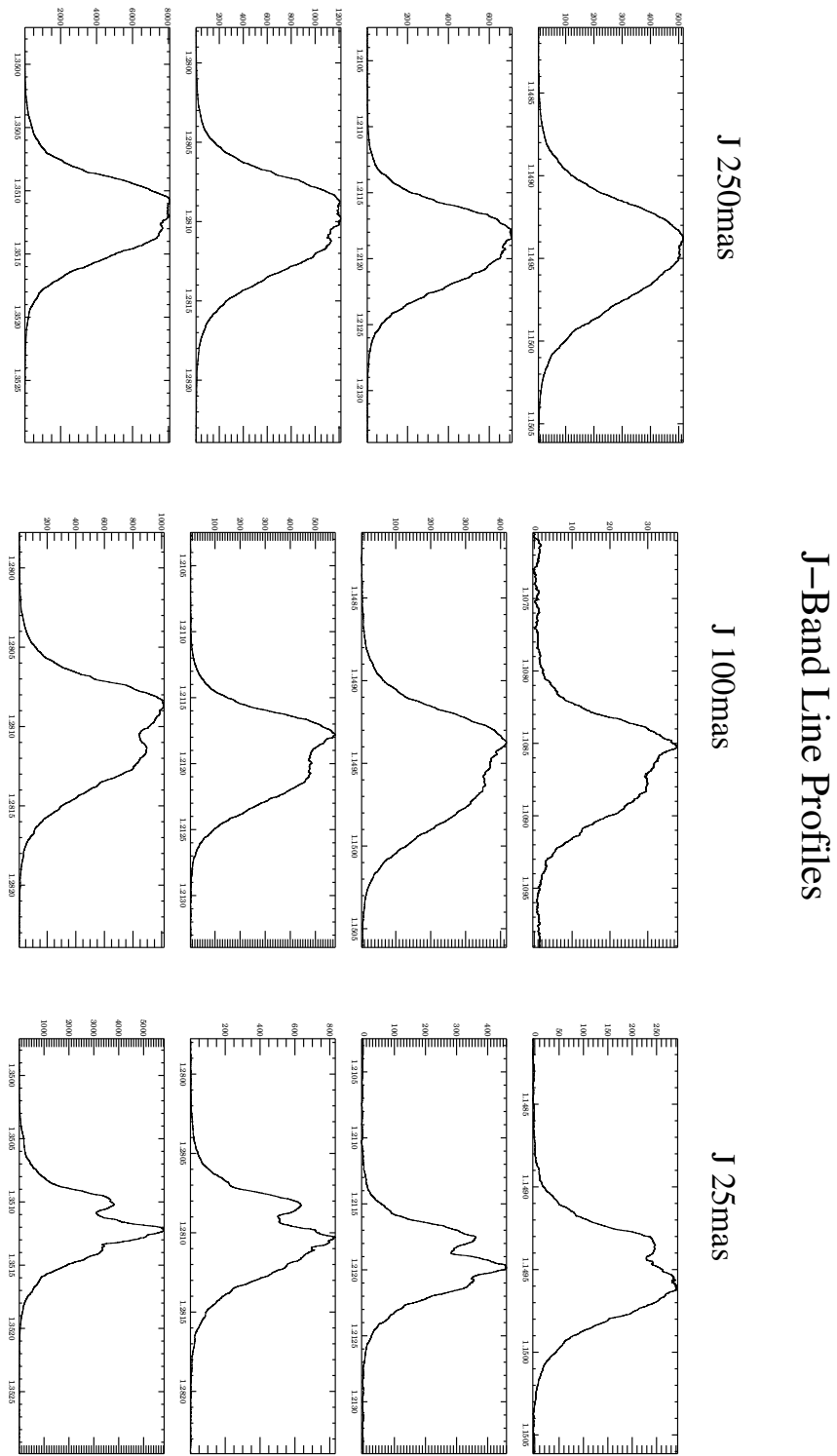

Figure 22: Spectral point spread function in the J band. For the three different plate-scales, for three regions on the detector (top to top: top to bottom on detector)

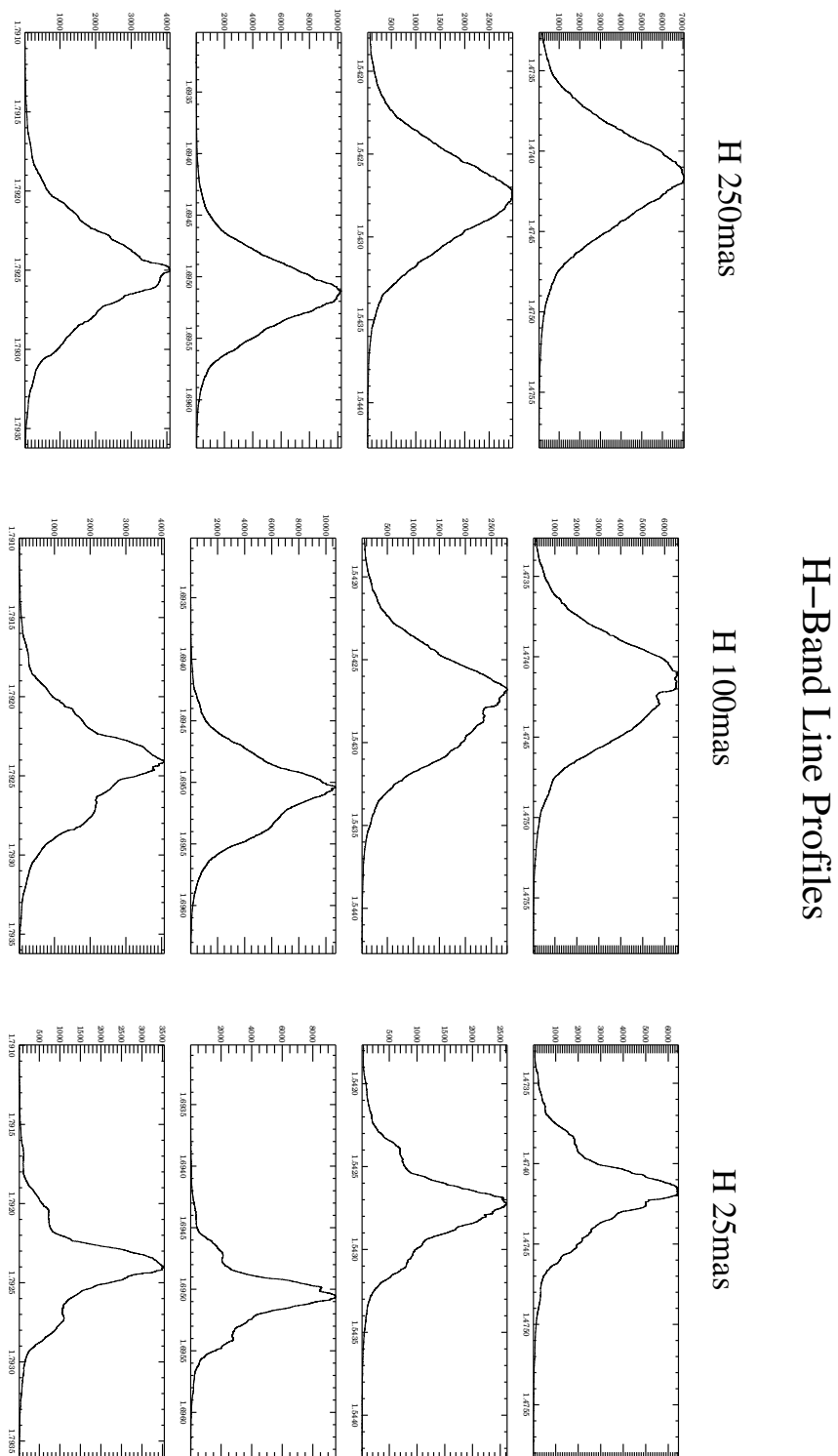

Figure 23: Spectral point spread function in the H band. For the three different plate-scales, for three regions on the detector (top to top: top to bottom on detector)

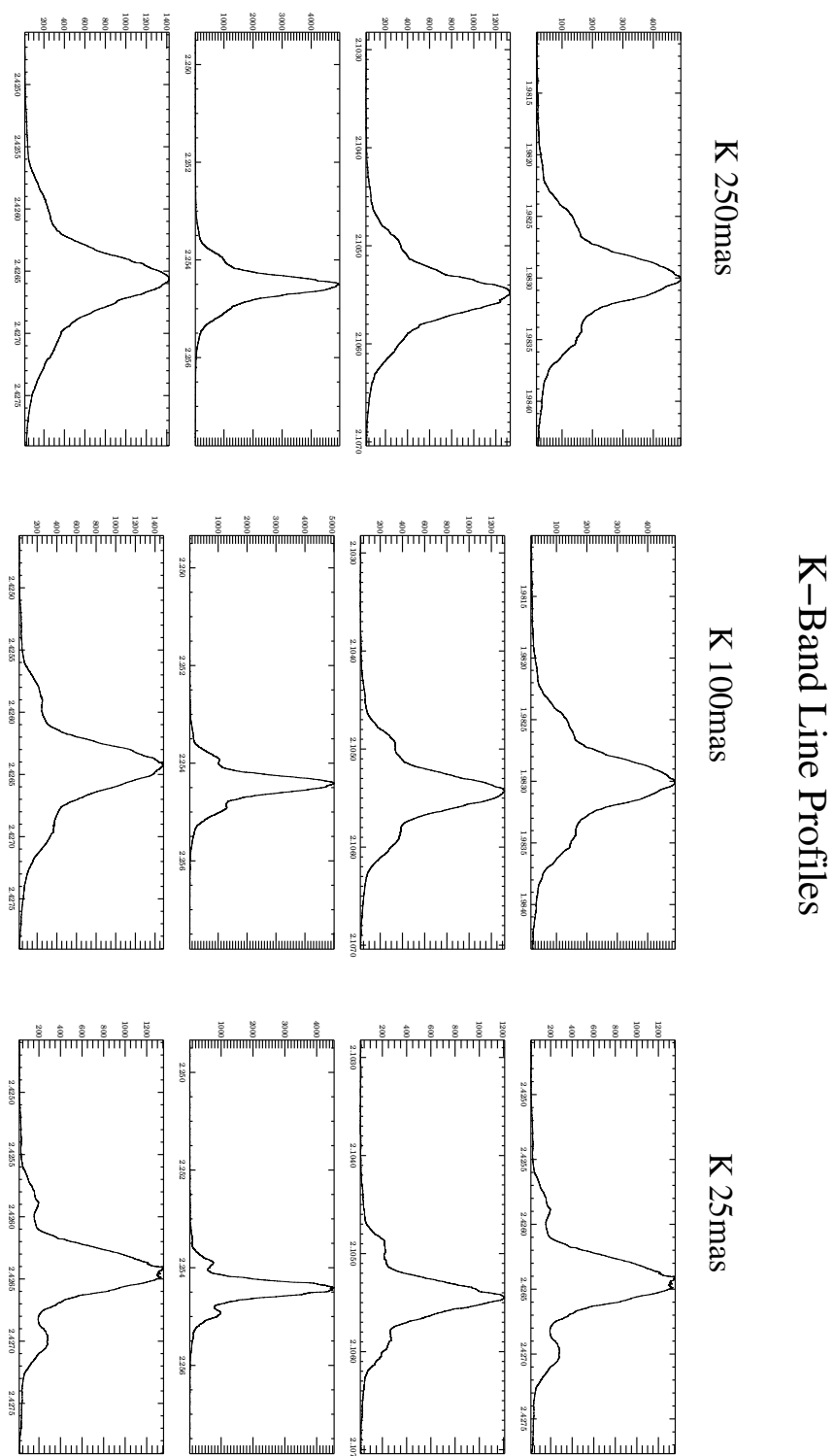

Figure 24: Spectral point spread function in the K band. For the three different plate-scales, for three regions on the detector (top to top: top to bottom on detector)

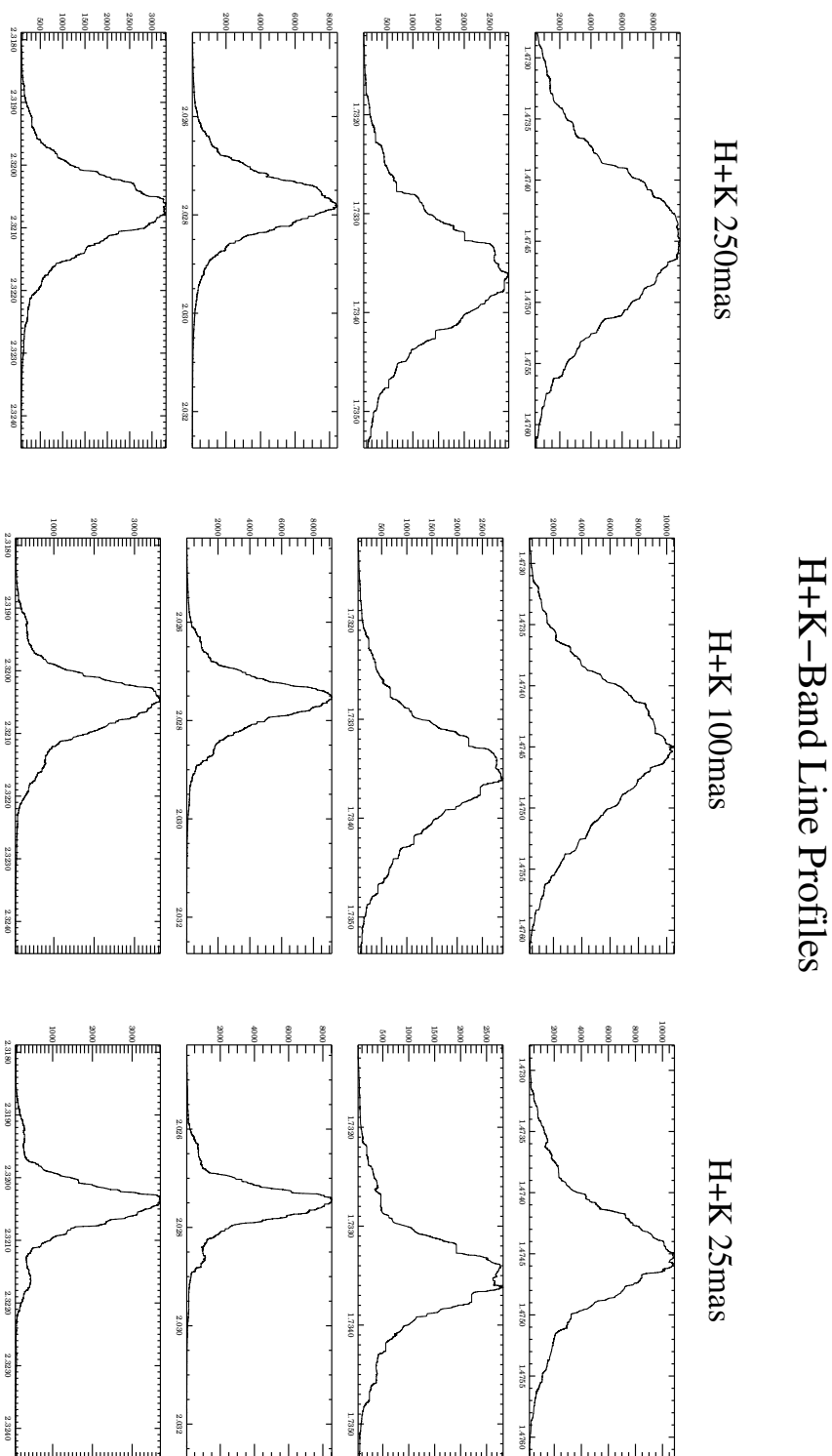

Figure 25: Spectral point spread function in the H+K band. For the three different plate-scales, for three regions on the detector (top to top: top to bottom on detector)