



EUROPEAN SOUTHERN OBSERVATORY

Organization Européenne pour des Recherches Astronomiques dans l'Hémisphère Austral
Europäische Organization für astronomische Forschung in der südlichen Hemisphäre

ESO - European Southern Observatory
Karl-Schwarzschild Str. 2, D-85748 Garching bei München

Very Large Telescope Paranal Science Operations VIRCAM/VISTA User Manual

Doc. No. VIS-MAN-ESO-06000-0002

Issue 85.0, Date 18/12/2009

Prepared V. D. Ivanov, T. Szeifert
.....
Date Signature

Approved A. Kaufer
.....
Date Signature

Released C. Dumas
.....
Date Signature

This page was intentionally left blank

Change Record

Issue	Date	Section affected	Reason/Initiation/Documents/Remarks
0.10	09/09/2008	All	Creation
1.00	18/12/2009	All	First public release for P85.
1.01	01/07/2010	All	Update for P86 Phase II and P87 Phase I.
1.02	01/12/2010	Twilight, overheads.	Update P87 Phase II.
1.03	11/03/2011	Minor updates.	Update P88 Phase I.
1.04	04/08/2011	Web links updated.	
1.05	13/06/2013	Template tile6sky info.	Update P92 Phase II.
1.06	29/08/2013	Minor updates.	Update P93 Phase I.

This page was intentionally left blank

Contents

1	Introduction	1
2	Applicable documents and other sources of information	3
3	Abbreviations and Acronyms	5
4	VISTA and VIRCAM in a nut-shell	6
5	The VISTA Telescope – Technical Description	7
6	The VIRCAM - VISTA Infra-Red Camera	9
6.1	General features	9
6.2	Detectors	11
6.3	Filters	15
6.4	Sensitivity	19
6.5	Low Order Wavefront Sensors and Autoguiders	19
6.6	High Order Wavefront Sensor Operation	20
7	Observations with VIRCAM@VISTA	24
7.1	Observations in the Infrared	24
7.1.1	The Infrared Sky	24
7.1.2	Selecting the best DIT and NDIT	25
7.2	Preparation for observations and general operation of VIRCAM@VISTA	26
7.3	Twilight Constraints	27
7.4	Pawprints, Tiles, Jitters, Microsteps	30
7.4.1	Definitions	30
7.4.2	“Filling-in” a tile with multiple pawprints	31
7.5	Scheduling Containers	33
7.6	Observing Strategy, Nesting	34
7.7	Autoguiding and AO operation	36
7.8	Overheads	36
7.9	Calibration Plan	37
7.9.1	Instrument signature removal	38
7.9.2	Photometric Calibration	41
7.9.3	Astrometric Calibration	43
7.9.4	Additional Calibrations Derived from Science Data and Related Observing Strategies	43
8	Data Flow, Pipeline, Quality Control	48
9	References and Acknowledgments	52
A	VISTA/VIRCAM Template Reference	53
A.1	Historic P86 Modifications of the Templates (Oct. 2010)	53
A.2	Historic P85 Modifications of the Templates (Feb. 2010)	53

A.3	Introduction to the Phase 2 Preparation for Public Surveys	53
A.4	The Acquisition Templates – VIRCAM_img_acq_tile and VIRCAM_img_acq_quick	55
A.5	The Science Observation Templates	57
A.5.1	VIRCAM_img_obs_tile<N>	57
A.5.2	VIRCAM_img_obs_tile6sky	64
A.5.3	VIRCAM_img_obs_paw	66
A.6	The Calibration Templates – VIRCAM_img_cal_illumination and VIRCAM_img_cal_std .	66
A.7	Template Parameter Tables	66
B	VISTA/VIRCAM Observing Blocks Cookbook	72
C	VISTA@VIRCAM FITS Header Description	74

1 Introduction

VISTA or Visible¹ and Infrared Survey Telescope for Astronomy is a specialized 4-m class wide field survey telescope for the Southern hemisphere. VISTA is located at ESO Cerro Paranal Observatory in Chile (longitude 70° 23' 51"W, latitude 24° 36' 57" S, elevation 2500 m above sea level) on its own peak about 1500 m N-NE from the Very Large Telescope (VLT).

The telescope has an alt-azimuth mount, and quasi-Ritchey-Chretien optics with a fast f/1 primary mirror giving an f/3.25 focus ratio at the Cassegrain focus. It is equipped with a near infrared camera VIRCAM or VISTA *InfraRed Camera* (with a 1.65 degree diameter field of view (FOV) at VISTA's nominal pixel size) containing 67 million pixels of mean size 0.339 arcsec × 0.339 arcsec. The instrument is connected to a Cassegrain rotator on the back of the primary mirror cell, and has a wide-field corrector lens system with three infrasil lenses. The available filters are: broad band *ZYJHK_S* and narrow band filter at NB980, NB990, and 1.18 micron. The point spread function (PSF) of the telescope+camera system delivers images with a full width at half maximum (FWHM) of ~0.51 arcsec (without the seeing effects). The weather characteristics and their statistics are similar to those for the VLT.

VISTA has one observing mode - imaging - and the telescope is used mostly in service mode to carry out surveys - programs exceeding in size and scope the usual ESO Large Programs. Typically, the observations are carried out in a 6-step pattern, called *tile*, designed to cover the gaps between the individual detectors.

The high data rate (on average 315 GB per night) and the large size of the individual files (256.7 MB) makes it a significant challenge for an individual user to cope with the data reduction challenges. The VISTA raw data are available via the ESO archive. High-level data products (i.e. photometry, catalog with object classification and derived physical parameters, etc.) are also available via the ESO archive for the ESO Public Surveys.

This manual is divided into several sections, including a technical description of the telescope and the camera, a section devoted to the observations with VISTA, including general information about the nature of the infrared sky, the operation of VISTA, the sensitivity of the instrument and a (preliminary) calibration plan. Next, the manual summarizes the data flow, the pipeline, and the parameters that are used for the quality control. Finally, the Appendix contains a template reference guide.

This manual was based on many documents, kindly provided by the VISTA consortium. The authors hope that you find it useful in your VISTA observations. The manual is continuously evolving with the maturing of the telescope and there will always be room for improvement. Comments from the users are especially welcomed. Please, refer to the ESO VISTA web site for contact details.

Nota Bene:

- The web page dedicated to VIRCAM/VISTA is accessible from the La Silla Paranal Observatory home page at: <http://www.eso.org/sci/facilities/paranal/instruments/vircam/> You will find there the most up-to-date information about VIRCAM/VISTA, including recent news, efficiency measurements and other useful data that do not easily fit into this manual or

¹A wide field visible camera was considered during the early stages of VISTA development, accounting for the visible component to the telescope name.

is subject of frequent changes. This web page is updated regularly.

An external (with respect to ESO) source with history of the project and relevant information is the VISTA consortium web-page at: <http://www.vista.ac.uk/index.html>

- Please, read the latest User Manual! It is located at:
<http://www.eso.org/sci/facilities/paranal/instruments/vircam/doc/>
- Contact information: for questions about VISTA and VIRCAM write to vista@eso.org; for questions about the service mode observations write to usd-help@eso.org

2 Applicable documents and other sources of information

Documents:

- VLT-MAN-ESO-00000-0000 OS Users' Manual
- VLT-MAN-ESO-00000-0000 DCS Users' Manual
- VLT-MAN-ESO-00000-0000 ICS Users' Manual
- VLT-MAN-ESO-00000-0000 P2PP Users' Manual
- VLT-MAN-ESO-00000-0000 SADT Cookbook

Web sites:

- ESO VIRCAM/VISTA main page:
<http://www.eso.org/sci/facilities/paranal/instruments/vircam/>
- VIRCAM/VISTA operation team contact list:
<http://www.eso.org/sci/facilities/paranal/instruments/vircam/iot.html>
- ESO Public Surveys:
<http://www.eso.org/sci/observing/policies/PublicSurveys/sciencePublicSurveys.html>
- ESO VIRCAM/VISTA Quality Control:
http://www.eso.org/observing/dfo/quality/index_vircam.html
- ESO Data Archive: <http://archive.eso.org/cms/>
- ESO P2PP3: <http://www.eso.org/sci/observing/phase2/P2PP3.html>
<http://www.eso.org/sci/observing/phase2/P2PP3/P2PP3Documentation.html>
- ESO SADT page: <http://www.eso.org/sci/observing/phase2/SMGuidelines/SADT.html>
<http://www.eso.org/sci/observing/phase2/SMGuidelines/SADT.VIRCAM.html>
- VIRCAM/VISTA Science Archive (at ROE): http://horus.roe.ac.uk/vsa/www/vsa_browser.html
- VIRCAM/VISTA Science Verification: <http://www.eso.org/sci/activities/vistasv.html>
- VIRCAM/VISTA Consortium: <http://www.vista.ac.uk/index.html>
- VIRCAM/VISTA at UK Astronomy Technology Centre:
<http://www.roe.ac.uk/ukatc/projects/vista/eso.html>
- Cambridge Astronomical Survey Unit (CASU): <http://casu.ast.cam.ac.uk/>
<http://www.ast.cam.ac.uk/~mike/casu/index.html>
- VIRCAM/VISTA Data Flow System (VDFS; at CASU): <http://www.ast.cam.ac.uk/vdfs/>
www.maths.qmul.ac.uk/~jpe/vdfs/

- Wide Field Astronomy Unit (WFAU): <http://www.roe.ac.uk/ifa/wfau/>
- Astronomical Wide-field Imaging System for Europe (Astro-WISE): <http://www.astro-wise.org/>
- Deep Near Infrared Survey of the Southern Sky (DENIS):
<http://cdsweb.u-strasbg.fr/denis.html>
- The Two Micron All Sky Survey (2MASS; at IPAC): <http://www.ipac.caltech.edu/2mass/>
- UKIRT IR Deep Sky Survey: <http://www.ukidss.org/>

3 Abbreviations and Acronyms

The abbreviations and acronyms used in this manual are described in Table 1.

Table 1: Abbreviations and Acronyms used in this manual.

ADU	Analog-Digital Units	MINDIT	Minimum DIT (= 1.0011 sec)
AG	Autoguider	NDIT	Number of DITs
AO	Adaptive Optics	NDR	Non-Destructive Read
BOB	Broker of Observing Blocks	NINT	Number of NDITs
CDS	Correlated Double Sample (IR detector readout mode)	NTT	New Technology Telescope
CP	Cryo-pump	OB	Observing Blocks
DFS	Data Flow System	OS	Observing Software
DAS	Detector Acquisition System	OT	Observing Tool
DCR	Double Correlated Read	P2PP	Phase 2 Proposal Preparation
DCS	Detector Control System	P2PP3	Phase 2 Proposal Preparation version 3
DEC	Declination	PSC	Point Source Catalog
DIT	Detector Integration Time	PDU	Power Drive Unit
ESO	European Southern Observatory	PSF	Point Spread Function
ETC	Exposure Time Calculator	RA	Right Ascension
FCA	Force Control Assembly	QC	Quality Control
FITS	Flexible-Image Transport System	RON	Read Out Noise
FOV	Field Of View	SADT	Survey Area Definition Tool
FPA	Focal Plane Assembly	SM	Service Mode
FWHM	Full Width at Half Maximum	SOFI	Son Of ISAAC
GFRP	Glass Fibre Reinforced Plastic	TBC	To Be Confirmed
HOWFS	High Order Wave Front (curvature) Sensor	TCS	Telescope Control System
ICRF	International Coordinate Reference Frame	TSF	Template Signature File
ICRS	International Celestial Reference System	UKIRT	United Kingdom Infrared Telescope
ICS	Instrument Control System	VDFS	VISTA Data Flow System
IR	Infra-Red	VIRCAM	VISTA InfraRed Camera
ISAAC	IR Spectrograph And Array Camera	VISTA	Visual and IR Survey Telescope for Astronomy
LOCS	Low Order Curvature Sensors	VLT	Very Large Telescope
LOWFS	Low Order Wave Front (curvature) Sensor (same as LOCS)	VM	Visitor Mode
LCU	Local Control Unit	VST	VLT Survey Telescope
M1	Primary Mirror	VPO	VISTA Project Office
M2	Secondary Mirror	WCS	World-Coordinate System
MAD	Median of Absolute Deviation	WFCAM	Wide-Field Camera (IR camera at UKIRT)
		ZP	Zero Point
		ZPN	Zenithal Polynomial (Projection)

4 VISTA and VIRCAM in a nut-shell

A summary of basic VISTA and VIRCAM related terms and concepts is given in Table 2.

Table 2: Short telescope and instrument description.

Item	Description
Telescope VISTA	a specialized 4-m telescope for surveys
Instrument VIRCAM	wide field 16 detector near-infrared camera
Location	VISTA peak at ESO Paranal Observatory (Latitude S24 37.5, Longitude W70 24.2, Altitude above sea level 2635.43 m)
Focus	f/1 primary giving a f/3.25 focus at the Cassegrain
Observing mode	imaging
Detectors	16 Raytheon VIRGO 2048 px×2048 px (HgCdTe on CdZnTe substrate) arrays
Total number of pixels	64 megapixels
Pixel size	square, average 0.339 arcsec on the side; for more details on the variation see Sec. 7.9.3
Image quality	FWHM=0.51 arcsec
Filters	<i>ZYJHK_s</i> , NB_980, NB_990, and NB_118
Integration	a simple snapshot, within the Data Acquisition System, of a specified Detector Integration Time
Exposure	the stored product in a file, a sum (not an average!) of many individual detector integrations
Pawprint	the 16 non-contiguous images of the sky produced by VIRCAM, with its 16 non-contiguous chips.
Tile	a contiguous area of sky obtained by combining multiple offsetted pawprints (filling in the gaps in a pawprint)
FOV of a single pawprint	~0.6 deg ² , with gaps
FOV of a tile	~1.64 deg ² filled FOV, obtained with a minimum of 6 exposures
Intradetector gaps	90% and 42.5% of the detector width
Image file size	256.7 MB
Nightly data rate	250 GB, peaking up to 600 GB

5 The VISTA Telescope – Technical Description

VISTA is a 4-m class wide field survey telescope (Figure 1). It has an alt-azimuth mount, and quasi-Ritchie-Chretien optics with a 4.10-m fast f/1 primary mirror (M1) giving an f/3.25 focus at the Cassegrain. The f/3 hyperboloid-shaped secondary (M2) has a diameter of 1.24-m. The unvignetted field of view is 2 deg (but VIRCAM uses only ~ 1.6 deg). The entrance pupil has a diameter of 3.70-m. The focal length is 12.072-m. The mirrors were coated with silver at the start of the VIRCAM operations in 2008, because was optimal for near-infrared performance. However, the silver coating suffered from fast aging so it was replaced with aluminum coating in 2011, and the current version of the VIRCAM ESO ETC reflects this change.

The total telescope mass (above the foundation peer) is ~ 113 metric tons, distributed among the optical support structure (~ 44), the azimuth rotation structure (~ 46) and the pedestal assembly (~ 23). The primary mirror weights 5520 kg, the VIRCAM – 2900 kg, the secondary mirror – 1000 kg. The telescope has three Power Drive Units (PDU) enabling movement of the azimuth and altitude axis, and the Cassegrain rotator. Unlike most other telescopes, VISTA lies on a ball bearing with a pitch diameter of 3658 mm, instead on a oil bed.

The Altitude limit is ≥ 20 deg above the horizon, which implies a *mechanical* pointing limit to the North at $\delta \leq +45$ deg at the meridian.

The VISTA theoretical pointing error over the entire sky is 0.5 arcsec. The open-loop tracking error over 5 min of observation is 0.22-0.24 arcsec. The telescope can operate under humidity of up to 80%. when the temperature is within the operational temperature range of $T=0-15$ C. VISTA can not observe within 2 deg from the zenith because of a rotator speed limitation.

The “jitter” movements are accomplished by moving the entire telescope (unlike the UKIRT for example, where this can be done via the tip-tilt mechanism of the secondary mirror). The overheads due to moving the telescope are 8 sec for a jitter, 15 sec for a pawprint, on average.

The optical layout of the telescope is shown in Figure 2. The telescope and the instrument should be treated as one integral design, i.e. the telescope is just foreoptics to the VIRCAM. The design is intertwined to the point that the telescope guider is part of the camera, i.e. it is within the camera dewar.

The primary mirror is manufactured from zerodur. Axial support is provided by 81 Force Control Assemblies (FCAs), mounted on the M1 cell, lateral support is carried out by four FCAs. The M2 position is controlled in 5 axis by a precision hexapod.

VIRCAM is connected to the telescope via a rotator on the back of the primary mirror cell, and has a wide-field corrector lens system with three infrasil lenses. The camera is described in the next section.

The enclosure rotates at nominal speed of 2 deg per second and is able to stop rotation within 5 sec. It can survive wind speed of up to 36 m s^{-1} **closed**. The nominal wind speed observing restrictions are: closing the dome at $\geq 18 \text{ m s}^{-1}$ and observing at least 90 deg away from the wind direction for $\geq 12 \text{ m s}^{-1}$.

The mirror coating is a major operation requiring dismounting of VIRCAM and the mirrors, and it implies interrupting the telescope operations for ~ 10 days.

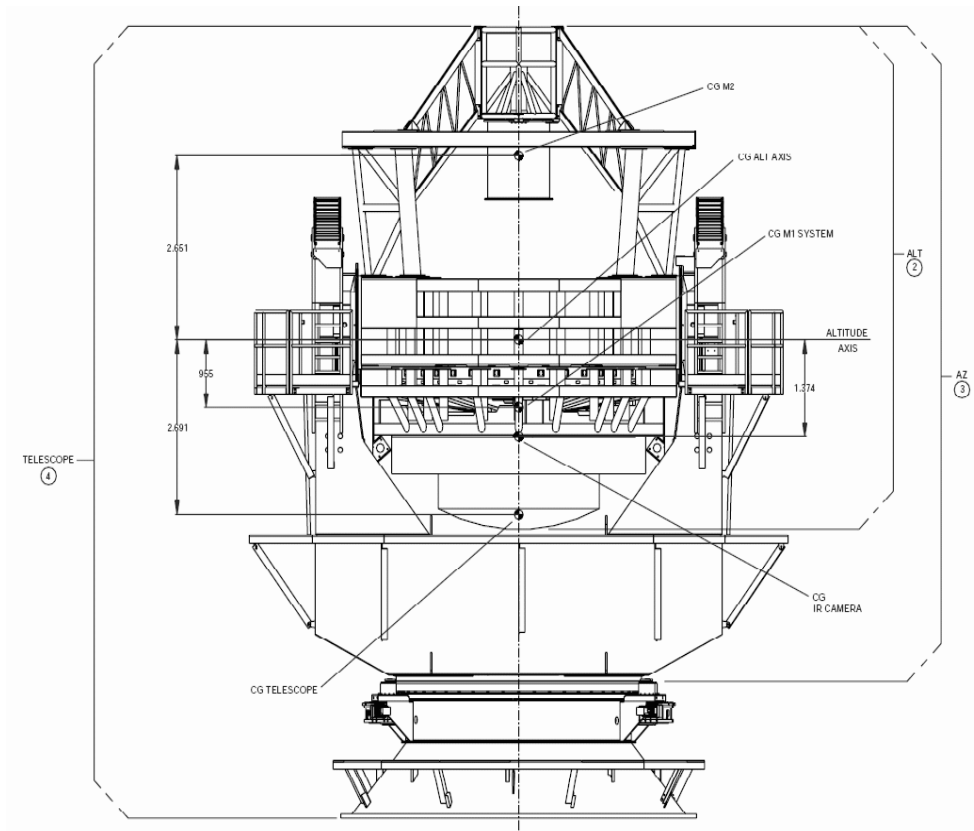

Figure 1: VISTA general view (CG - Cassegrain).

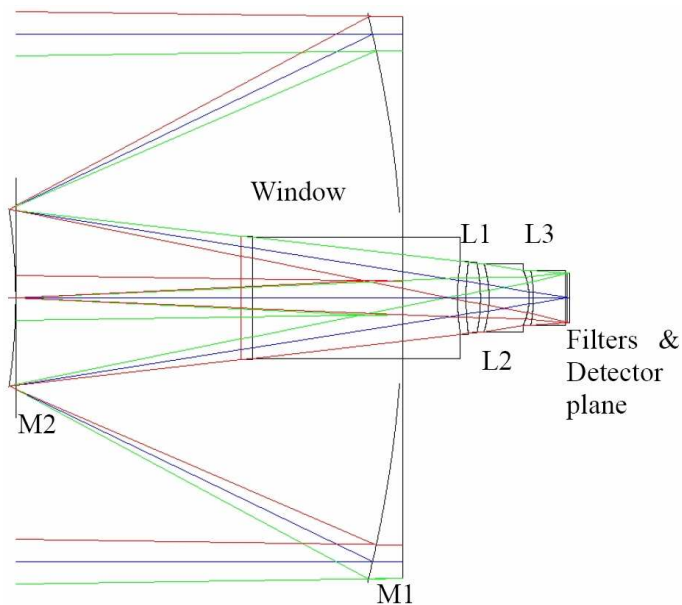

Figure 2: Optical layout of the telescope. M1 and M2 are the telescope primary and secondary mirrors. The camera's entrance window, the three lenses L1, L2, and L3, the filter and the detector planes are also marked.

6 The VIRCAM - VISTA Infra-Red Camera

6.1 General features

The infrared camera VIRCAM (Figure 3) is a state-of-the art design, the largest of its kind, as of 2010. It has a very wide field of view with 1.65 deg diameter. The camera uses a long cryostat with seven nested cold baffles to block out-of-beam radiation instead of the usual re-imaging optics or cold pupil stop design that has been most common so far. In addition, the baffles serve to reject the unwanted heat load from the window by means of a specialized coating which is highly absorbing at wavelengths shortward of $3\ \mu\text{m}$ and highly reflective longward of $3\ \mu\text{m}$.

The baffling system still leaves a smooth gradient caused by scattered thermal radiation across the detectors in the K_S band; the total intensity of this scattered background is expected to be $\sim 20\%$ of the sky level and the gradient may be up to 10% of that, i.e. $\sim 2\%$ of total sky level, including the “real” sky emission and the scattered light. This effect must be addressed during the data processing. On the positive side, the absence of a cold stop means that there is no intermediate focus, so there should be no issue with “nearly in focus” warm dust particles.

The aluminum cryostat housing the camera consists of four main sections, and includes over 10-m of O-ring seals. The nominal vacuum level is 10^{-6} millibar, and it is achieved in two stages: an initial pump-down with an external pump followed by pumping with a pair of He closed cycle cryopumps.

The Cassegrain rotator has a full-range of 540 deg so that the position angle of the focal plane with respect to the sky may be chosen freely. The autoguiders are fully 180-deg symmetric, so if desired one can observe a field at two camera angles 180 deg apart while re-using the same guide star and Low Order Wavefront Sensors (LOWFS) stars, but with proper paf files and re-acquisition, to re-assign the guide stars to the opposite LOWFS.

The camera faces forward, towards the secondary mirror. The light, after bouncing off the primary and the secondary, enters the instrument through a 95 cm diameter entrance window, and then it passes through three corrector lenses (all made of IR-grade fused silica), and the filter wheel, to reach the 16 detectors assembly at the focal plane. The lenses remove the field curvature to allow a large grid of detectors to be used, while controlling the off-axis aberrations and chromatic effects. The optical layout of the telescope+camera system is shown in Figure 2, and camera cut offs are shown in Figures 3 and 4.

Two fixed autoguiders and active optics wave-front sensors are integral part of the camera. They use CCDs operating at $\sim 800\ \text{nm}$ (roughly I-band), to control the telescope tracking and to achieve active optics control at the telescope, to correct the flexure and other opto-mechanical effects arising from both the telescope and camera parts of the system. There are two Low Order Wavefront Sensors (LOWFS), a High Order Wavefront Sensor (HOWFS), and the light reaches them via corresponding beamsplitters to provide two out-of-focus images, used in the analysis.

The VIRCAM field distortion can be noticeable: it is expected that the difference between the pixel scale averaged over the entire field of view and the on-axis pixel scale may reach 0.89%, with up to three times larger radial variations (for more details on the pixel scale variation across the field of view see Sec. 7.9.3). Therefore, pixels can be combined without re-binning only for small jitters up to $\sim 10\ \text{px}$, and if no microsteps are used (because they by default are fractions of the pixel size). However, in most cases the sky background removal will dictate the usage of larger jitters, and the data reduction will require re-binning of pixels when co-adding frames at different jitter positions.

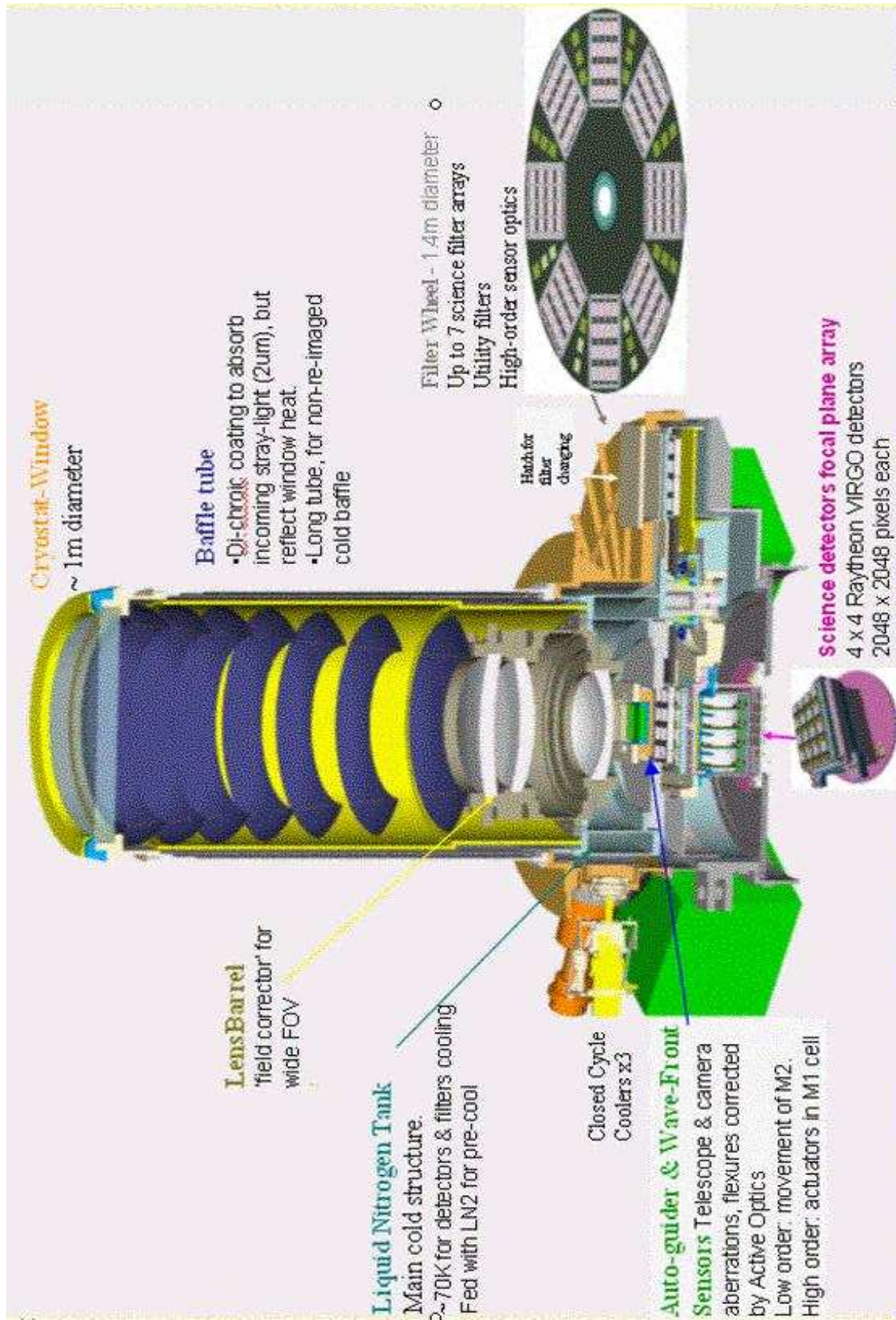

Figure 3: VIRCAM general view.

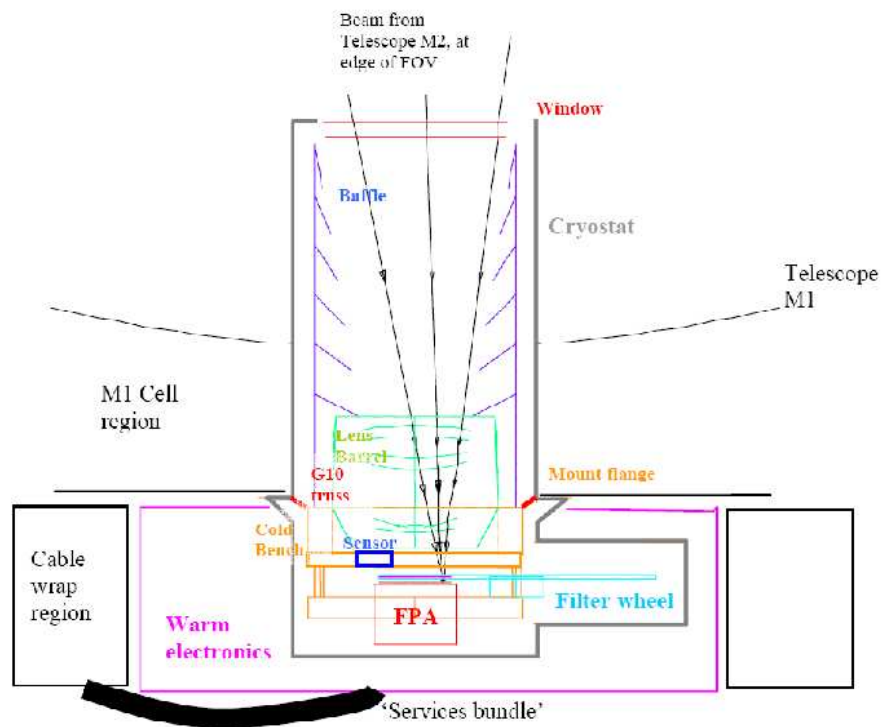

Figure 4: VIRCAM optical layout.

During normal operation the camera is maintained at temperature $T \sim 72$ K. The immediate camera cooling is achieved by circulating liquid nitrogen. The total camera cooldown time is 3 days.

The IR Camera is designed with the intent that it will remain in continuous operation at cryogenic temperatures for a full year on the telescope, with a minimum annual downtime scheduled for preventative maintenance and any filter changes – barring any failures that might require emergency intervention.

6.2 Detectors

VIRCAM contains 16 Raytheon VIRGO $2048 \text{ px} \times 2048 \text{ px}$ HgCdTe science detectors (64 megapixels in total), covering 0.59 deg^2 per single pointing, called a **pawprint** (i.e. taken without moving the telescope). The spacing between the arrays is 90% and 42.5% of the detector size, along the X and Y axis, respectively (Figure 5; the science detectors are marked as green squares). Therefore, a single pointing provides only a partial coverage of the field of view. A complete, contiguous coverage of the entire $1.5 \times 1 \text{ deg}$ field of view can be obtained with a six-point observing sequence, called a **tile**. For more details on the tile and achieving a full contiguous coverage see Section 7.4. The focal plane assembly, in addition to the science detectors, contains two autoguider CCDs, and two active optics (or Low Order Wave Front Sensor) CCDs, also shown in Figure 5 as blue rectangles and blue squares, respectively. They will be described in detail in Sec 6.5.

The telescope+camera optics together produce an on-axis plate scale on the camera focal plane of $17.0887 \text{ arcsec mm}^{-1}$, with a focal length of 12.07 m. Each detector pixel size is $20 \mu\text{m}$, and the 2048×2048 pixel detectors cover an area of $40.96 \text{ mm} \times 40.96 \text{ mm}$ on the focal plane. The pincushion distortion (due to projection effects between the spherical sky and flat focal plane, and due to residual distortions in the optical system) causes the detectors further from the optical axis to cover a smaller area on the sky. The mean pixel size across the entire focal plane is

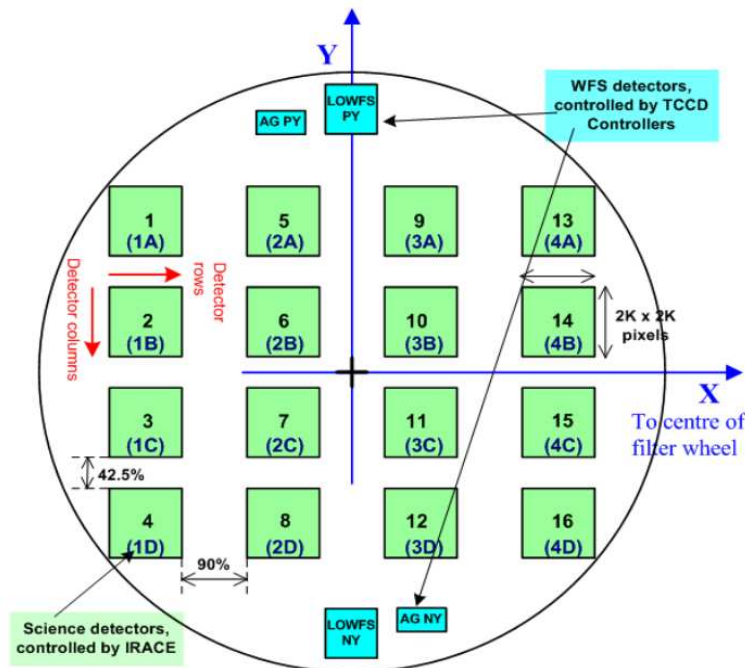

Figure 5: VIRCAM detector plane looking “down” on it from “above”. On the sky the detectors are placed in a mirror image with detector No. 1 in the top right. The numbers in brackets at each science detector indicate the number of the IRACE controller used to run the corresponding detector. The wavefront sensors are also shown. The gaps between the detectors are ~ 10.4 and ~ 4.9 arcmin, along the X and Y axis, respectively. Each detector covers $\sim 11.6 \times 11.6$ arcmin on the sky. North is up, and East is to the right, for rotator offset 0.0.

$0.339 \text{ arcsec px}^{-1}$ on the sky, and each detector covers a $\sim 694 \times 694 \text{ arcsec}^2$ area of sky. The 16 detectors cover $274.432 \text{ mm} \times 216.064 \text{ mm}$ on the focal plane, which gives a nominal field of view of $1.292 \times 1.017 \text{ deg}$ on the sky. To ensure the flatness of the focal plane assembly (FPA), all pixels are enclosed between two planes, separated by $25 \mu\text{m}$, measured along the optical axis of the camera. In other words, the distance between the most deviating pixels, measured along the optical axis is $\leq 25 \mu\text{m}$.

The Nyquist sampling suggests an image quality of $\sim 0.68 \text{ arcsec}$ but it is expected to gain a factor of ~ 0.7 (yielding FWHM $\sim 0.5 \text{ arcsec}$) in resolution because of the sub-pixel sampling. The science detectors are sensitive over the wavelength range $0.85\text{--}2.4 \mu\text{m}$. The detector readout time is $\sim 1 \text{ sec}$ and the size of a single file is $\sim 256.7 \text{ MB}$.

The mean quantum efficiencies of all 16 detectors are: $(Z, Y, J, H, K_S) = (70, 80, 90, 96, 92)\%$. A plot of the quantum efficiency as function of wavelength for this type of the detectors is shown in Figure 6. In addition, the combined losses due to reflection off all VIRCAM lens surfaces are 3-5%.

The science detectors are read out simultaneously by four enhanced ESO IRACE IR controllers, with a total of 256 simultaneous readout channels, so each detector is read into 16 stripes of 2048×128 pixels. The minimum detector integration time is 1.0011 sec.

All detectors but one are linear to $\leq 4.6\%$ for illumination levels below 10000 ADU, and for the worst one the non-linearity at this level is $\sim 10\%$ (Table 3). There is also a small non-linearity of 1-2% at low illumination levels ($< 1000 \text{ ADU}$) that affects all detectors. It can not be measured with the calibration plan linearity monitoring but the effect is negligible. These values may change with time, check the VIRCAM web page for more up to date information. The linearity is correctable for up to $\sim 25000 \text{ ADU}$ (the number varies for the different detectors). The stability of the non-linearity

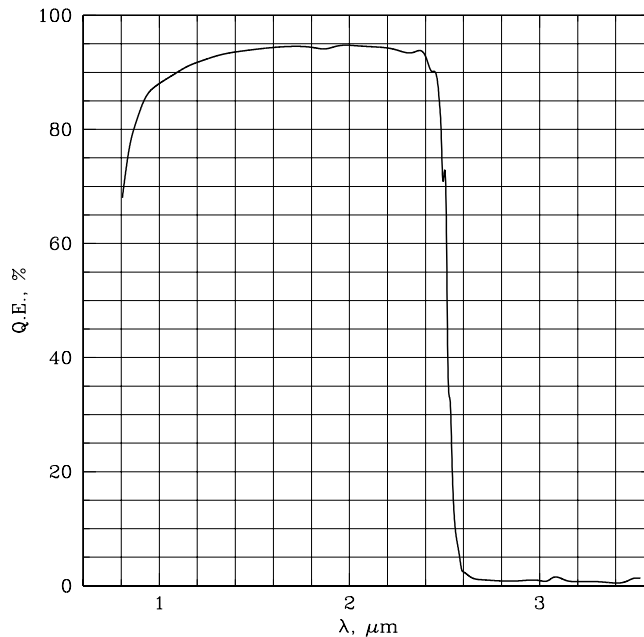

Figure 6: Quantum efficiency of the VIRCAM Virgo detectors. Note the long-wavelength tail at $\lambda \geq 2.5 \mu\text{m}$.

corrections will be studied and reported later.

The detectors are read in the standard Double-Correlated mode, which means an image of length DIT seconds is effectively the difference of an exposures of (DIT+1.0011) sec and 1.0011 sec.

Well-depths for the arrays (defined as the point at which the non-linearity of the response exceeds 5%) range between 110000 and 180000 e^- , for a bias voltage set at 0.7 V. For a typical gain of $\sim 4.3 e^- \text{ADU}^{-1}$, these correspond to ~ 26000 and 42000 ADU. The average saturation levels of the detectors are listed in Table 3. Note that these are averaged over each detector, and the saturation levels of the pixels within the detector also vary. This effect is particularly noticeable in detector No. 5.

Cosmetically, the best detectors are No. 5 and 10, and the worst are No. 1, 2, 16 and 3. The parameters of individual detectors are summarized in Table 3 for standard readout mode. Table 4 lists some parameters related to the saturation of the detectors. Properties of the detector dark current are described in Table 5. The values given here may change with time, check the VIRCAM web page for the most up to date information.

The flat fielding is exceptionally stable - after the flat fielding correction the images show r.m.s. of 0.004-0.005 which promises photometry of nearly milimag quality, taking into account that the stellar images will spread over 4-9 pixels or more, depending on the seeing, on an individual exposure, and that the jittering and the microstepping will allow averaging over even more pixels. Note, that currently the users are discouraged to use microstepping because it tends to produce artificial patterns on the reduced images.

The VIRGO detectors suffer from some persistence. A measurement from May 12, 2010 is shown in Fig. 7. First, five dome flats were taken with DIT=8 sec to measure the flux in ADU sec^{-1} , then 5 dome flats with DIT=80 sec were taken, yielding a nominal flux of $\sim 400000 \text{ADU}$, and heavily saturating the detectors. Next, 12 more dark frames with DIT=300 sec were taken to measure the actual persistence effect and its decay. The reference dark level that has been subtracted from the measured persistence was retrieved from a dark taken 8 hr later. The log-ADU versus log-time

Table 3: Properties of the VIRCAM science detectors. Different types of bad pixels are measured by pipeline recipes, and the adopted definitions slightly vary, hence the inconsistency. The last two lines give the average values and their r.m.s., over all 16 detectors. Saturation and non-linearity measurements are based on data from 2009-06-08.

Detector No.	Gain, e^- ADU $^{-1}$	Read-out noise, e^-	Hot pixels fraction, %	Bad pixels fraction, %	Saturation, ADU	Non-linearity deviation at 10000 ADU, %
1	3.7	23.9	0.45	1.93	33000	2.2
2	4.2	24.4	0.51	1.30	32000	3.3
3	4.0	22.8	0.93	0.91	33000	3.8
4	4.2	24.0	0.45	0.63	32000	3.5
5	4.2	24.4	0.32	0.14	24000	2.0
6	4.1	23.6	0.33	0.23	36000	3.0
7	3.9	23.1	0.38	0.22	35000	2.0
8	4.2	24.3	0.34	0.32	33000	3.4
9	4.6	19.0	0.35	0.27	35000	3.3
10	4.0	24.9	0.33	0.10	35000	4.4
11	4.6	24.1	0.35	0.24	37000	4.6
12	4.0	23.8	0.38	0.22	34000	2.6
13	5.8	26.6	0.94	0.90	33000	10.0
14	4.8	18.7	0.61	0.97	35000	2.7
15	4.0	17.7	0.32	0.53	34000	1.7
16	5.0	20.8	0.27	1.43	34000	3.3
Average 1–16	4.3	22.9	0.45	0.65	33438	3.5
r.m.s.	0.5	2.5	0.21	0.54	2874	1.9

Table 4: VIRCAM@VISTA sensitivities (for 0.8 arcsec seeing in 2 arcsec diameter apertures), saturation levels and other related parameters for individual filters (minimum detector integration time DIT=1.0011 sec adopted). Atmospheric extinction color terms listed are the coefficients in front of $(J-H)$, except for K_S , where it is $(J-K_S)$. **All values in the table are approximate. For the most recent measurements use the VIRCAM web page and ETC.**

Band	Z	Y	J	H	K_S	NB980	NB990	NB1.18
Star Magnitude yielding peak image value of ~ 30000 ADU	11.3	10.8	11.1	11.0	10.2	TBD	TBD	TBD
Aver. sky brightness, mag arcsec $^{-2}$	18.2	17.2	16.0	14.1	13.0	TBD	TBD	16.3
Average background level, ADU	41	64	254	1376	1925	TBD	TBD	TBD
DIT at which the background alone saturates an average detector, sec	1207	787	197	36	26	TBD	TBD	TBD
Recommended maximum DIT, sec	60	60	30	10	10	TBD	TBD	TBD
Atm. Ext. coeff., mag airmass $^{-1}$	TBD	TBD	0.1	0.08	0.08	TBD	TBD	TBD
5σ in 1-min limiting mag (Vega=0)	21.3	20.6	20.2	19.3	18.3	TBD	TBD	17.9
Measured on-sky Zero Points (mag yielding flux of 1 ADU sec $^{-1}$)	23.82	23.45	23.78	23.87	23.03	20.95	TBD	20.83
$(J-H)$ color term with resp. to 2MASS	+1.025	+0.610	-0.077	+0.032	TBD	0.680	TBD	+0.100
$(J-K_S)$ color term with resp. to 2MASS	TBD	TBD	-0.065	TBD	+0.010	TBD	TBD	TBD

Table 5: Daytime dark current counts in ADU averaged over the individual detectors, for number of different DITs (columns 2-11). The last column contains the average dark current rate for each detector, calculated from the measurements with $\text{DIT} \geq 50$ sec. Based on data from 2009-05-21.

Detector	Detector Integration Time (DIT), seconds										Dark current ADU sec ⁻¹
	10	50	75	100	125	150	200	250	275	300	
1	14.6	20.2	22.7	25.1	27.1	29.2	32.9	36.2	37.9	39.4	17.2±0.4
2	3.3	5.5	6.7	8.3	9.5	11.3	14.1	16.9	18.1	19.7	2.5±0.1
3	6.4	17.2	17.7	27.3	25.0	35.0	41.0	45.7	44.8	49.7	11.2±2.3
4	6.8	16.5	21.0	25.3	29.5	33.2	40.6	47.7	51.2	54.4	10.0±0.5
5	4.0	5.5	6.2	6.9	7.5	8.1	9.2	10.2	10.7	11.2	4.6±0.1
6	4.1	6.5	7.5	8.5	9.3	10.1	11.5	12.9	13.6	14.2	5.3±0.1
7	4.6	7.9	9.7	11.2	12.7	14.2	16.8	19.3	20.5	21.6	5.7±0.2
8	8.0	15.6	18.4	20.4	22.4	23.9	26.7	29.1	30.3	31.3	14.1±0.6
9	6.3	13.4	16.7	19.3	21.6	23.7	27.4	30.7	32.3	33.8	11.0±0.6
10	4.0	4.3	4.3	4.5	4.5	4.7	4.8	5.0	5.0	5.1	4.1±0.0
11	5.3	11.0	13.8	16.3	18.5	20.4	24.1	27.6	29.3	30.9	8.2±0.4
12	5.6	9.8	11.5	12.8	14.0	15.0	16.6	18.1	18.7	19.3	8.9±0.4
13	18.4	50.8	67.6	82.2	97.9	110.5	136.8	161.4	174.2	185.3	28.4±1.9
14	49.3	144.6	185.8	221.5	254.1	283.7	339.8	389.3	413.2	436.0	103.1±6.9
15	3.5	4.5	5.0	5.5	5.8	6.2	6.9	7.5	7.8	8.1	4.0±0.1
16	17.7	40.1	47.0	52.3	56.8	60.6	67.3	73.1	76.0	78.4	36.5±1.5

diagram shows the decay as a straight line, so the persistence was fit by a power law where the time after the saturation t is in seconds, and the coefficient a is in ADU sec⁻¹: $P(t) = a \times t^{-m}$ [ADU sec⁻¹], giving the excess in the count rate. The best fit parameters a and m are given in Table 6, together with the counts for the extrapolated initial lamp flux f .

For the latest information about the persistence and other known detector issues, visit:

<http://www.eso.org/observing/dfo/quality/VIRCAM/pipeline/problems.html>

6.3 Filters

The filter exchange wheel (1.37-m diameter) is the only moving part of the camera. It has eight main slots – seven for science filters and one for a dark. The science filter positions actually contain “trays” – each with a 4×4 array of square glass filters designed to match the 4×4 array of science

Table 6: Fitting coefficients for the VIRCAM persistence for the individual detectors.

Detector	f , ADU	a , ADU sec ⁻¹	m	Detector	f , ADU	a , ADU sec ⁻¹	m
01	460260	30	-0.77	09	359700	243	-1.11
02	283510	27	-0.74	10	376500	236	-1.15
03	326020	100	-0.87	11	351710	250	-1.13
04	371620	60	-0.90	12	384880	540	-1.18
05	380410	112	-1.02	13	282690	10902	-1.70
06	430810	135	-1.02	14	372010	129	-1.09
07	413130	283	-1.10	15	428480	203	-1.13
08	346750	189	-1.05	16	323570	46	-1.10

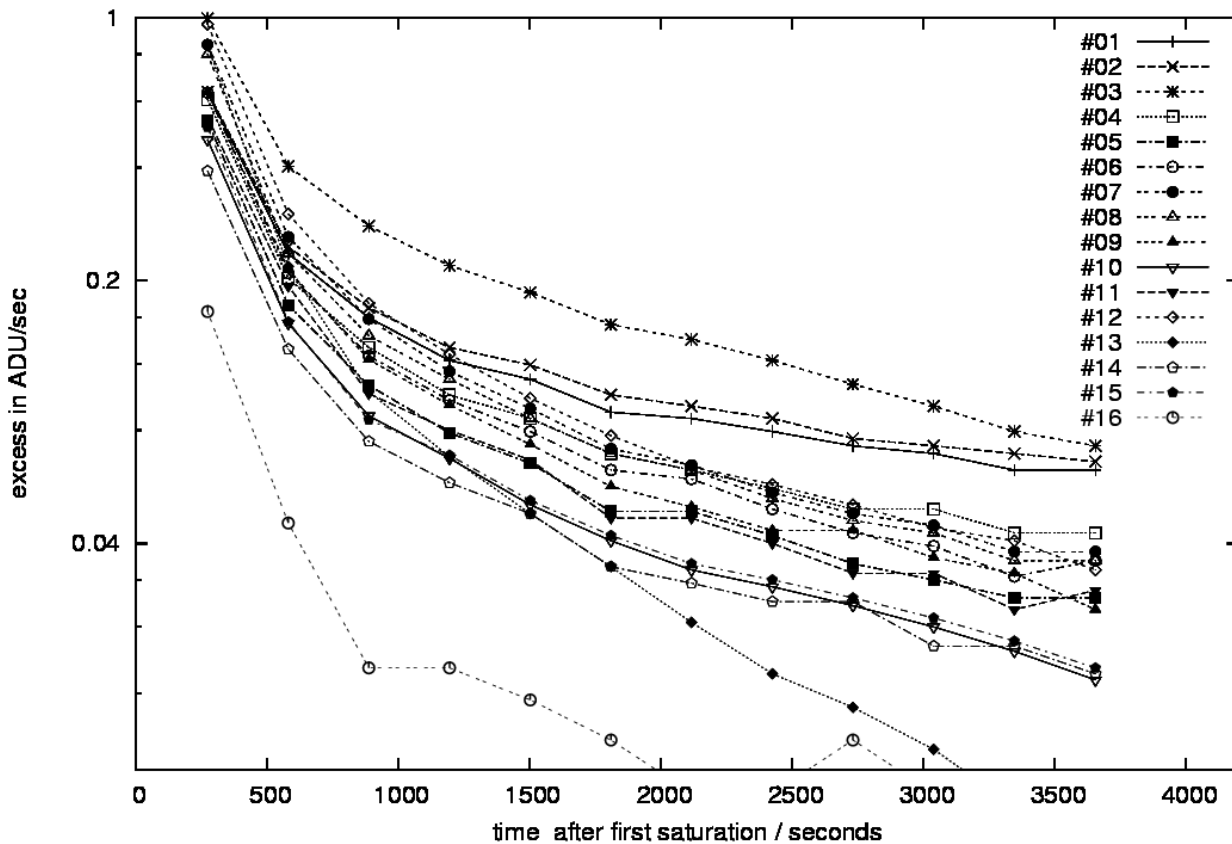

Figure 7: VIRCAM persistence for the individual detectors.

detectors. The wheel is driven with a step motor and it is positioned by counting the number of motor steps from a reference switch. The available science filters are listed in Table 7 and their parameters are given in Table 8. The filter transmission curves are plotted in Figure 8. VIRCAM@VISTA uses a K_S filter similar to 2MASS but unlike WFCAM@UKIRT which uses a broader K filter.

Note that the NB 980 tray slot actually contains two different types of filters, split equally between NB 980 and NB 990. To obtain homogeneous coverage of the sky with both of them the users should observe the survey area twice, with position angles separated by 180 deg, for example 0 and 180, 90 and 270, etc. The symmetry of the AG and AO CCD should allow to use the same reference sources for both observations. The information which type of filter is located in each tray spot will be provided later on the VISTA web page.

Filter exchange time is expected to be ~ 15 -45 sec depending on the required rotation angle. The filter wheel rotates in both directions, so the shortest path is chosen during nominal operation; this is clearly longer than the time for a jitter or for a tiling telescope move, so it is generally more

Table 7: Location of the VIRCAM filters in the filter wheel slots. "INT 3" is the intermediate slot No. 3.

Slot	Filter	Slot	Filter	Slot	Filter
1	SUNBLIND	INT 3	HOWFS J beam splitter	6	Y
2	NB 980 ¹	4	K_S	7	Z
3	H	5	J	8	NB 118

¹ Two different types of filters NB 980 and NB 990 are located in the tray in this slot, for their parameters see Table 8.

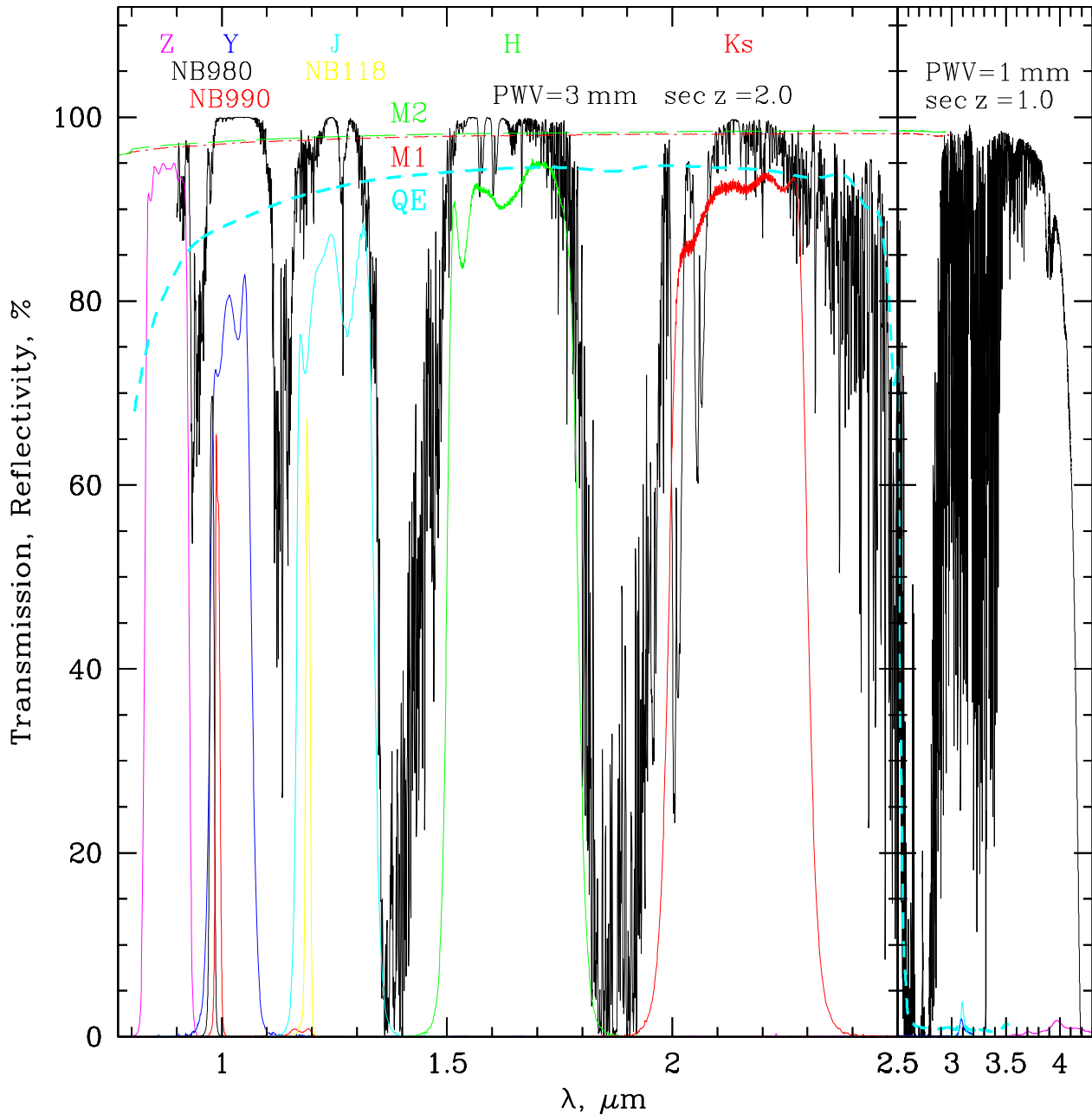

Figure 8: Transmission curves for the filters (colored solid lines, labelled on the top), detector quantum efficiency (short-dashed line, labeled QE), reflectivity of the primary and the secondary mirrors (dot-dashed and long-dashed lines, labelled M1 and M2, respectively), and atmospheric transmission curve (solid black line, labelled on the top with the precipitable water vapor PWV in mm, and with the airmass $\sec z$). The right panel shows the long wavelength filter transmission leaks and the detector quantum efficiency. Note that the atmospheric transmission on the left panel is poor, while on the right panel is good, to demonstrate the worst case scenarios. The left and the right panel have different X-axis scales for clarity.

Table 8: Parameters of the VIRCAM filters. Parameters for the two types of filters located in the NB 980 slot are given.

Band	Z	Y	J	H	K_S	NB 980/990	NB 1.18
Nominal Central Wavelength (μm)	0.88	1.02	1.25	1.65	2.15	0.978/0.991	1.185
Nominal Bandwidth FWHM (μm)	0.12	0.10	0.18	0.30	0.30	0.009/0.010	0.01
Minimum Camera Throughput	0.67	0.57	0.60	0.72	0.70	TBD/TBD	TBD

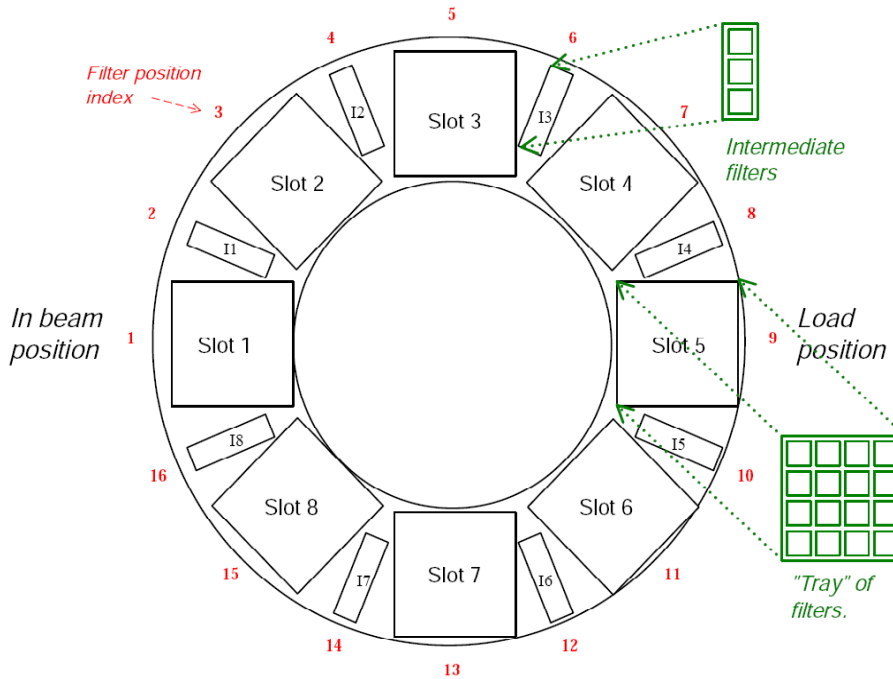

Figure 9: Layout of the VIRCAM filter wheel.

efficient (and gives better sky subtraction) to complete a tile in one filter, then change filter and repeat the tile. A full wheel revolution corresponds to 210000 half-steps of the step motor, and requires ~ 53 seconds at maximum speed.

A filter change is likely to cause a small warming of the detectors, because of the non-uniform temperature across the wheel. This effect is corrected by the temperature servo system, so the temperature rise should be < 0.1 K for a few minutes after the change. With a wheel temperature < 110 K, photon emission from the wheel itself should always be negligible.

The wedge-shaped spaces in between the science filter trays can be populated with smaller “intermediate” filters that only cover a subset of the science detectors and are designed for specific unique calibration observations and engineering tests. These filters don’t cover the entire focal FPA, but they can be shifted to cover a few different detectors by rotating the filter wheel slightly. The beam splitters for the high order wavefront sensor (HOWFS) fit into these intermediate positions.

The VISTA filter wheel control software “knows” the approximate transparency of each filter, and it is designed to protect the detectors from being flashed unnecessarily with ambient light by selecting a wheel movement path which passes the least number of “bright” filters through the beam.

6.4 Sensitivity

The VISTA sensitivities for different filters, the average sky brightness on the site, and other relevant items are listed in Table 4. These values change with time. For example, the zero points gradually degrade over time between the mirror re-coatings. The degradation can reach up to $\sim 7\%$ for the bluest bands and up to $\sim 2\text{-}3\%$ for K_S as seen from the plots² in Fig. 10–13. Mirror coatings are evident in Sept 2009 and Apr 2011, as well as the silver coating degradation in late-2010 – early-2011. Please, check the VIRCAM web page for the most up to date information.

6.5 Low Order Wavefront Sensors and Autoguiders

The camera incorporates six CCD detectors grouped into two units (+Y and –Y) that provide auto-guiding and wavefront sensing information to the VISTA telescope control system, for the purpose of active control of the telescope optics, to correct the flexure and various opto-mechanical effects arising from both the telescope and camera parts of the system.

There are two Low Order Curvature Sensors/Autoguiders (LOWFS/AGs) units – self-contained sub-systems, mounted between the third camera lens and the filter wheel assembly, next to the infrared detectors (Figure 5). They can sample the beam as close as possible to the science field of view. Each unit contains three *e2v Technologies* type CCD 42-40 2048 \times 2048 CCDs with pixel scale ~ 0.23 arcsec px⁻¹). The first of them uses only half of the field of view (8 \times 4 arcmin) for speed, and it provides auto-guiding capability for the telescope at up to 10 Hz frame rate for a 100 \times 100 pixel window. The other two CCDs are mounted at the two outputs of a cuboid beamsplitter arrangement which provides pre- and post-focal images for wavefront curvature analysis. They use the full field of view (8 \times 8 arcmin). From a software perspective the LOWFS/AG units logically are part of the telescope control system (TCS) rather than the instrument control system (ICS).

The guide sensor operates concurrently with the science observations. It is expected that the guide sensor can start to operate within 30 min after sunset, but this may require to choose the telescope pointing placing a suitably bright guide star in the LOWFS/AG field of view. The field of view of the AG units covers sufficiently large area, so there is a 99% probability of finding a suitable guide star, for a random telescope pointing in the region of Galactic Pole at Full Moon.

The start and end of exposure on the two wavefront analysis CCDs of one sensor are coincident within 1 sec and the estimated Zernike coefficients are sent to the TCS within 15 sec from the completion of the LOWFS/AG exposures. The autoguiding and the wavefront analysis add negligible overhead to the science observations – less than 0.5 sec per LOWFS frame. In other words, the LOWFS/AGs are “slaved” to the science readouts and telescope dithers to make sure the autoguiding doesn’t interfere with the observations. **The use of the LOWFSs imposes a minimum time between jitter moves of ~ 45 sec since they have to complete an exposure with adequate S/N in between consecutive jitter moves.** If it is essential to jitter more often than once per 45 sec, then the observations will be taken in open-loop AO. In this case an initial AO correction will be performed before starting the sequence of jitter offsets, and periodic AO corrections will be performed between the exposures. These AO corrections will be repeated periodically, after the validity (in time) of last AO correction expires. The validity is determined by the AO priority (HIGH, NORMAL or LOW).

A software enhancement may be added to enable co-adding two or more 15-sec LOWFS exposures of the same star with relative jitter shifts - this is not currently implemented but is under consideration as a software enhancement. If it is implemented, a simple co-add of LOWFS images with a shift by the nearest-integer number of pixels will be used.

There is only one case when a significant overhead from the LOWFSs may arise – after a telescope slew giving a large (>10 deg) change in altitude, and the AO priority is set to HIGH: in this case

²From <http://casu.ast.cam.ac.uk/surveys-projects/vista/technical/photometric-properties>

there will probably be a need for a 45 sec pause for one LOWFS cycle to be completed to update the M2 position at the new altitude, before science observing can re-start (see Sec. A.4).

Given the LOWFS fields (8×8 arcmin) of view, generally a “jitter” move of ~ 15 arcsec will re-use the same guide and wavefront sensor stars by simply offsetting the selected readout window in software, whereas a “tiling” move of 5-10 arcmin nearly always will require different guide and AO reference stars to be selected after the move.

There are various “graceful degradation” modes in the event of hardware failure of one sensor, unavailability of stars, etc; these include reducing the autoguider frame rate, and/or operating with one LOWFS and 3-axis M2 control.

There is no non-sidereal guiding and no closed-loop wavefront sensing during tracking of a non-sidereal target.

6.6 High Order Wavefront Sensor Operation

The high order wavefront (curvature) sensor (HOWFS) uses some of the science detectors to determine occasional adjustments to the primary mirror support system. (This is done perhaps once at the start of the night and once around midnight.) Processing the signals from the HOWFS is done within the Instrument Workstation, and so the pipeline will not have to deal with the HOWFS related data.

HOWFS cannot to operate concurrently with science observations. The telescope can be offset to illuminate directly the sensor with a bright star, limiting the necessary FOV. The sensor within the IR Camera software package allows a suitable star to be selected. The estimates suggest that there is a 99% probability of finding a suitable star within 1 deg of any telescope position. The required integration time will be ≤ 180 sec, in most cases ≤ 60 sec. The HOWFS will generate at least 22 Zernike or quasi-Zernike coefficients, so that the root-sum-square error of all 22 coefficients is ≤ 50 nm. After adopting a curvature sensing solution, a “stepped” filter at one or more of the “intermediate” filter positions on the filter wheel is used to illuminate one of the science detectors in e.g. J passband for verification. The HOWFS data are stored in the same manner as science exposures.

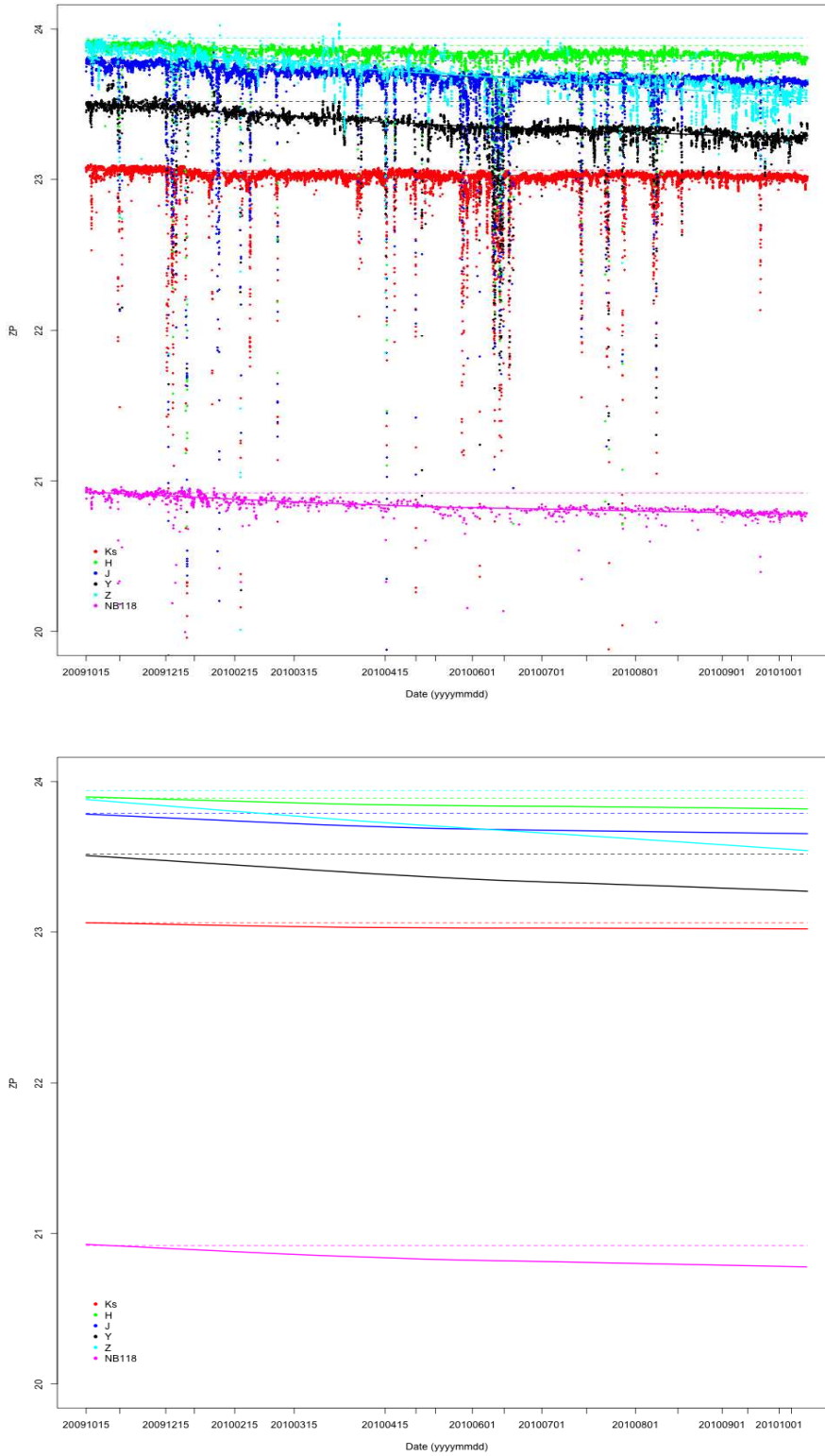

Figure 10: Zero point trends during the first year of operation 2009-2010. Courtesy of CASU.

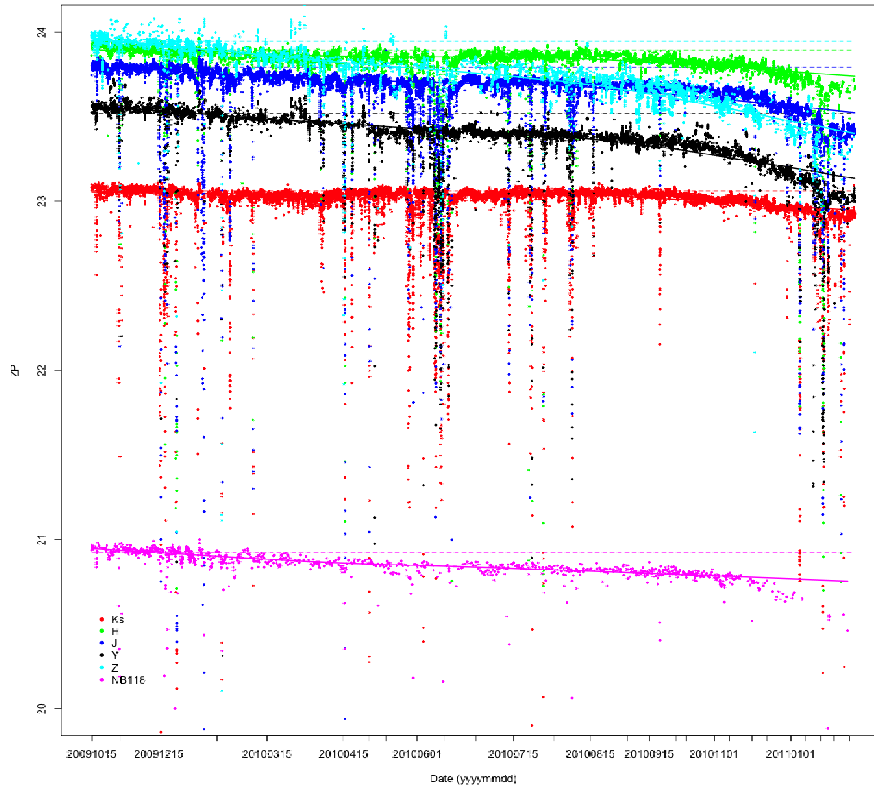

Figure 11: Zero point trends in 2010–2011. Courtesy of CASU.

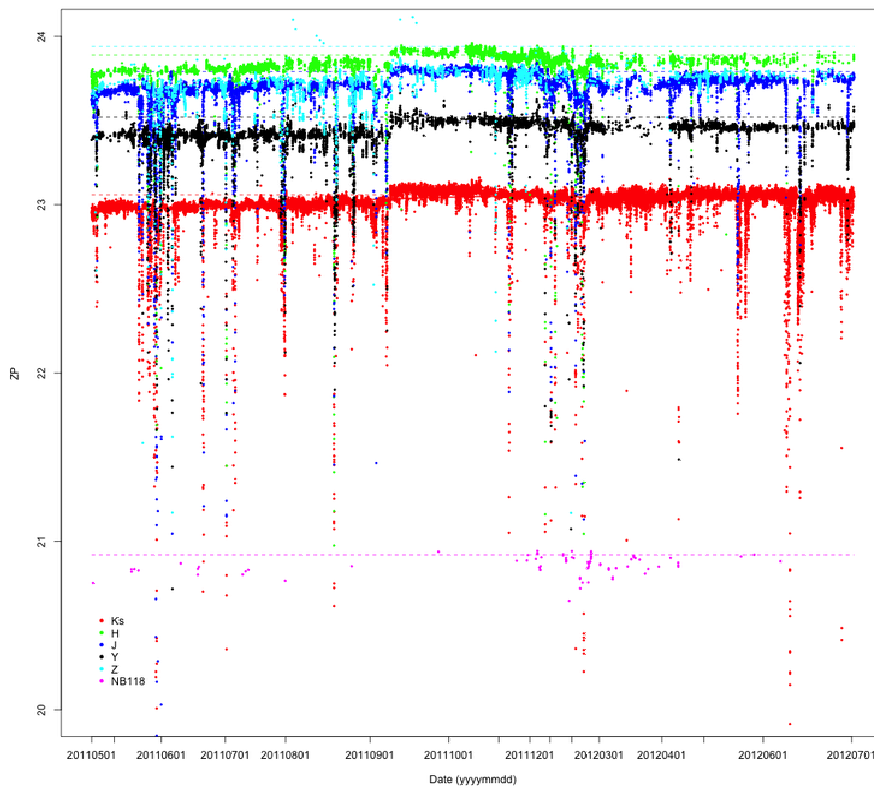

Figure 12: Zero point trends in 2011–2012. Courtesy of CASU.

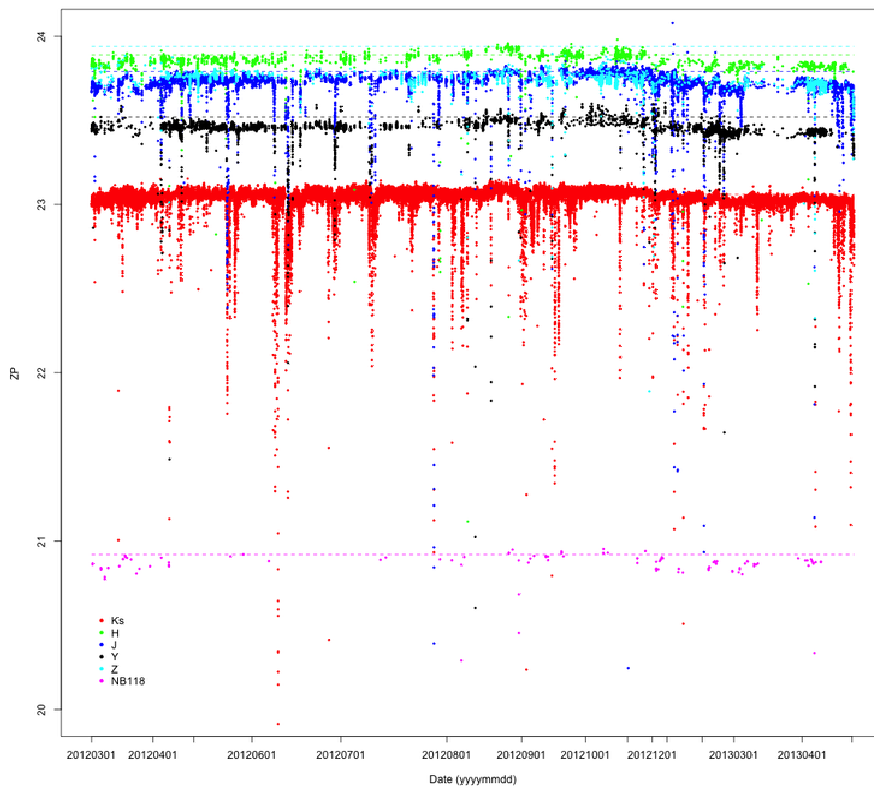

Figure 13: Zero point trends in 2012–2013. Courtesy of CASU.

7 Observations with VIRCAM@VISTA

This chapter summarizes the experience, accumulated over many years of NIR observations at ESO. It borrows from the similar discussions in ISAAC and SofI user manuals.

7.1 Observations in the Infrared

7.1.1 The Infrared Sky

Observing in the IR is more complex than observing in the optical. The difference arises from a higher and more variable background, and from stronger atmospheric absorption and telluric emission throughout the 1 to 2.5 micron wavelength region.

Short-ward of 2.3 microns, the background is dominated by non-thermal emission, principally by aurora, OH and O₂ emission lines. The vibrationally excited OH lines are highly variable on a time scale of a few minutes. Pronounced diurnal variations also occur: the lines are strongest just after sunset and weakest a few hours after midnight. A complete description and atlas of the sky emission lines can be found in the paper of Rousselot et al. (2000, A&A, 354, 1134).

Long-ward of 2.3 microns, the background is dominated by thermal emission from both the telescope and the sky, and it is principally a function of the temperature. The background in K_S can vary by a factor of two between the winter and summer months but is more stable than the J or H band background on minute-long time-scale. It also depends on the cleanliness of the primary mirror. Imaging in broadband K_S can result in backgrounds of up to a couple of thousand ADU sec⁻¹, depending strongly on the temperature and humidity.

The Moon has negligible influence on the sky background, longward of 1 μm . However, the background in Z and Y filters can be affected.

The IR window between 1 and 2.5 microns contains many absorption features that are primarily due to water vapor and carbon dioxide in the atmosphere. These features are time varying and they depend non-linearly on airmass. The atmosphere between the J and H bands and between the H and K_S bands is almost completely opaque. The atmospheric transmission between 0.5 and 2.5 microns is plotted in Figure 8 (middle panel). As the amount of water vapor varies so will the amount of absorption. The edges of the atmospheric windows are highly variable which is important for the stability of the photometry in J and K_S filters (but to a lesser extent for J_S).

These difficulties have led to the development of specific observing techniques for the IR. These techniques are encapsulated in the templates (see for details Appendix A) that are used to control VIRCAM and the telescope.

It is not unusual for the objects of interest to be hundreds or even thousands of times fainter than the sky. Under these conditions it has become standard practice to observe the source (together with the inevitable underlying sky) and subtract from it an estimate of the sky, obtained from images taken away from the target, or moving the target on different locations in the detector (also known as jittering). Since the sky emission is generally variable, the only way to obtain good sky cancellation is to do this frequently. The frequency depends on the wavelength of observation (and respectively on the nature of the sky background emission) and on meteorological conditions. Ideally, one would like to estimate the sky more frequently than the time scale of the sky variations. While this could

be done quickly with the traditional single- and especially double-channel photometers, the overhead in observing with array detectors and the necessity of integrating sufficient photons to achieve background limited performance are such that the frequency is of the order of once per minute. In exceptionally stable conditions the sky can be sampled once every two or three minutes. This sky subtraction technique has the additional advantage that it automatically removes fixed electronic patterns (sometimes called “bias”) and dark current.

NOTA BENE: The *sky* and the *object+sky* have to be sampled equally; integrating more on the *object+sky* than on the *sky* will not improve the overall signal-to-noise ratio because the noise will be dominated by the *sky*.

7.1.2 Selecting the best DIT and NDIT

Selecting the best DIT and NDIT is a complex optimization problem and it depends on the nature of the program: type of the targets, necessary signal-to-noise, frequency of sky sampling, etc. Therefore, it is hard to give general suggestions and the users should exercise their judgment and discuss their choices with the support astronomer.

The first constraint is to keep the signal from the target within the linear part of the detector array dynamic range below ~ 25000 ADU (Tables 3 and 4; for a discussion on the detector non-linearity see Sec. 6.2). Considering the large VIRCAM field of view, it is likely that a number of bright stars will fall into the field of view, and they will illuminate the detectors with signal well above the non-linearity limits. The data reduction pipeline is designed to correct at least partially the effects of non-linearity and cross-talk, caused by these sources. However, the requirement to keep the signal from the science target below the non-linearity limit is paramount. The only way to do that is to reduce the detector integration time. Unfortunately, small DIT values of 1-2 sec increase greatly the overheads to ≥ 50 -100%, because the overhead associated with every DIT is ~ 2 sec. For comparison, observations with DIT=10-20 sec have an overhead of $\sim 10\%$.

The sky background is another factor that has to be accounted for when selecting a DIT (Table 4). It is the strongest in K_S band, followed closely by the H band. It depends strongly on the temperature and humidity. The sky background can easily saturate the array by itself if the user selects a long DIT. Thin clouds and moon light can elevate the sky background significantly in Z , Y , and even in J . The recommended maximum DITs for the five broad band filters are listed in Table 4. These values will keep the detector potential wells below the linearity limit minimizing problems with the saturation, persistence, non linearity, dynamic range, and not saturating the entire dynamic range of the Two Micron All Sky Survey (2MASS; Skrutskie et al. 2006, AJ, 131, 1163) stars. The values quoted in the tables may change with time, check the VIRCAM web page for more up to date information.

Background limited observations: The RON can be neglected for DITs ≥ 60 sec, ≥ 60 sec, ≥ 20 sec, ≥ 5 sec, and ≥ 1.5 sec for the $NB980$, $NB990$, $NB118$, Z , Y , and J filters, respectively.

The background variations – on a time scale of a 1-3 minutes – are a source of systematic uncertainties. To account for them the user must monitor these variations on the same time scale. As mentioned above, this is done by alternatively observing the target and a clear sky field next to the target every 1-3 minutes. The exact frequency of the sky sampling is determined by the product $DIT \times NDIT$, plus the overhead – if the DIT value is set by the linearity constraint, the frequency of the sky sampling determines the NDIT.

The observer can verify the choice of the sky sampling frequency by subtracting sequential images from one another and by monitoring how large is the average residual. Ideally, it should be smaller than or comparable to the expected Poisson noise but this is rarely the case. Usually, a few tens or a few hundred ADUs are considered acceptable by most users.

Finally, the total integration time is accumulated by obtaining a certain number of images, specified by the total number of exposures/offsets, the number of jittered images at each position, the number of microsteps, and the location of the object in the field of view (note the overlapping areas at the edges of the detectors in Figure 20, that get longer total exposure time). If relatively long integrations are necessary, it is simply a matter of increasing the number of exposures, respectively, the number of tiles or pawprints. However, in the cases when the total required time can be accumulated in less than 5-7 exposures it might become difficult to create a good sky for the sky subtraction, especially if the field is crowded because the sky image may contain residuals from the stellar images that will produce “holes” in the sky-subtracted data. This situation will require to adopt a strategy with an increased number of exposures above 5 to 7. It might be possible to compensate this increase by decreasing correspondingly NDIT to keep the total integration time constant. Still, there will be some increase in the overheads. Alternatively, the sky may be constructed combining a few nearby pointings/tiles.

Summarizing, under average conditions, for faint targets, one can safely use $DIT=40-60$, $20-40$, $5-30$, $1-10$ and $1-10$ sec for Z , Y , J , H and K_S filters, respectively. The narrow band filters can tolerate DITs of up to a few minutes. Brighter targets require to reduce these times, in some cases all the way down to the minimum DIT of 1.0011 sec for 13-18 mag stars (see above). The users may even have to consider splitting their observations into “shallow” and “deep” sequences, optimized for different magnitude ranges. High humidity can also affect the sky background, in particular in H where it is dominated by OH and water emission lines, and for some of the detectors (note – that the detectors have different gain and non-linearity limits!) DIT-10 sec may be too much for this filter. One more complication is caused by the nature of the target. If it is point-source-like, or a sparse field of point-source-like objects, the simple dither or a tile will suffice to create a sky frame. For objects that fill in a significant fraction of a chip or for very crowded fields, it is necessary to image the sky and the object separately, effectively adding 100% overhead. Unfortunately, it is common that the sky frames will contain other objects, and it is not uncommon that one of these objects will be in the same region of the array(s) as the science object. To avoid this it is important to jitter the sky images as well. The experience shows that a reasonable minimum number of the sky images (and respectively, the object-sky pairs) is 5-7, to ensure a good removal of the objects from the sky frames. Note that this may lead to an extra overhead because in some cases the NDIT has to be reduced artificially (contrary to the optimization strategy discussed above) to a number below the optimal, just to split the total integration into 5-7 images, adding an extra overhead for the telescope offsets. Considering the large field of view of VIRCAM, the user may encounter these problems only for a handful of objects, i.e. the Galactic Center, the Magellanic Clouds.

7.2 Preparation for observations and general operation of VIRCAM@VISTA

The VIRCAM@VISTA observations are executed – as for all ESO telescopes – using Observing Blocks (OBs) that are prepared with the Phase 2 Proposal Preparation Tool version 3 (P2PP3). However, there is an extra preliminary step for the Public Surveys – to define the survey area with the Survey Area Definition Tool (SADT) that determines the optimal tiling and finds guide star candidates and active optics reference star candidates for LOWFS. Before preparing the observations the user should read the SADT manual, the P2PP3 manual and the guidelines provided on the Phase 2 web pages, selecting VIRCAM in the Instrument Selector on the upper right:

<http://www.eso.org/sci/observing/phase2/SMGuidelines.html>

The actual observations are in effect executions of semi-automatic scripts, with minimal human intervention, restricted usually to quality control of the data, and real time decisions about the short-term service mode scheduling. The care and attention during the preparation stage is critical for optimizing the observations.

First the user defines the survey area, and the observing strategy (more details are provided in the

next sections). Second, the SADT is used to determine the coordinates of the tiles and the suitable guide star and active optics reference star candidates:

<http://www.eso.org/sci/observing/phase2/SMGuidelines/SADT.html>

Third, the OBs are prepared with P2PP3:

<http://www.eso.org/sci/observing/phase2/P2PP3.html>

This new version of P2PP3 enables the definition of more complex survey strategy through the use of scheduling containers (see Sec. 7.5).

The user should remember that the maximum total duration of an imaging OB in Service Mode can not exceed 1 hr (the maximum duration of a concatenation is also 1 hr). Longer OBs may be acceptable but ESO can not guarantee that the weather conditions will remain within the requested specification after the first hour, i.e. even if the conditions deteriorate after 1 hr of observation, the OB will still be completed and considered executed. In this case the user should request in advance a waiver from the User Support Department:

<http://www.eso.org/sci/observing/phase2/SMGuidelines/WaiverChanges.VIRCAM.html>

The SADT step of the preparations often must be repeated many times. To save time and for a quick view of the survey area tiling the user can initially turn the autoguiding and wavefront reference stars search flags off in the SADT preferences but the AO/AG reference sources are necessary for the surveys, and the flags have to be turned back on, before producing and exporting the final survey tiling configuration.

Once the AO/AG reference star search is turned on, and the SADT is re-run, the user will find that the number of tiles necessary to cover the survey area depends strongly on the available AO/AG reference stars. The area, within which the SADT searches for such stars, for each offset position, in turn depends on the SADT parameter **Maximum Jitter Amplitude** (listed in Table 9; it is discussed in detail in the SADT Cookbook). If the maximum jitter value is very large, it would be difficult to find reference stars, especially away from the Galactic plane. A maximum jitter value smaller than the one used in the templates of the OBs later would cause loss of reference stars during some of the jitter offsets, and image quality degradation.

The large field of view of VIRCAM@VISTA implies that closer to the celestial poles the rectangles representing the tiles (with sizes listed in Table 16) do not follow well the lines of constant declination. The users should keep this in mind when observing areas with $\text{Dec} \leq -60$ deg where the effect is strongly pronounced. The same effect is present near the Southern Galactic pole, if the survey is defined in Galactic coordinates. Refer to the SADT Cookbook for more detailed instructions how to address this problem. These and other related issues are discussed in greater detail in the SADT Cookbook.

The observations are carried out in service mode by the ESO Paranal Science Operations. During the VIRCAM@VISTA nominal operating mode for science observations, the camera and the telescope are driven by the pre-defined OBs. The instrument is actively cooled, the IR detector system is continuously taking exposures. The images are only recorded upon command triggered by an executed OB. In normal conditions the filter wheel moves periodically to exchange filters upon request, the AG and LOWFS sensors are continuously recording images and passing data to the TCS for the active optics operation.

The raw data are subjected to quality control. They are delivered via USB disks to the ESO Science Archive in Garching, and are made available to the PIs upon request.

7.3 Twilight Constraints

Infrared instruments are commonly used for observations in twilight but the bluest VIRCAM/VISTA filters can be severely affected by the elevated sky background during twilight. To give the users a better control over the conditions under which their observations will be executed, we introduced a

Table 9: Maximum Jitter Amplitudes for different jitter patterns. The actual deviation from the central position during the jitter is \pm *Maximum Jitter Amplitude*, i.e. it is half of the total extension of the jitter pattern movement. The different patterns are described in Sec. A, Table 18, and they are plotted in Fig. 26.

Jitter Pattern	Maximum Jitter amplitude, arcsec	Short jitter pattern description
Single	0	No jitter
Jitter2d	$10 \times$ <i>Jitter Scale Multiplier</i>	2 point jitter - top left to bottom right
Jitter2u	$10 \times$ <i>Jitter Scale Multiplier</i>	2 point jitter - bottom left to top right
Jitter2da	$20 \times$ <i>Jitter Scale Multiplier</i>	2 point jitter - bottom left to top right
Jitter2ua	$20 \times$ <i>Jitter Scale Multiplier</i>	2 point jitter - top left to bottom right
Jitter3d	$10 \times$ <i>Jitter Scale Multiplier</i>	3 point jitter - top left to bottom right
Jitter3u	$10 \times$ <i>Jitter Scale Multiplier</i>	3 point jitter - bottom left to top right
Jitter4u	$14 \times$ <i>Jitter Scale Multiplier</i>	4 point jitter rotated u shape
Jitter5n	$9 \times$ <i>Jitter Scale Multiplier</i>	5 point jitter rotated n shape
Jitter5z	$14 \times$ <i>Jitter Scale Multiplier</i>	5 point jitter rotated z shape
Jitter9s	$14 \times$ <i>Jitter Scale Multiplier</i>	9 point jitter - rotated square shape
Jitter25s	$14 \times$ <i>Jitter Scale Multiplier</i>	25 point jitter - spiral pattern
Jitter30r1	$10 \times$ <i>Jitter Scale Multiplier</i>	30 point jitter - fixed pattern, pre-generated with a random number generator
Random	Use value set for amplitude of the random jitter pattern	This is not a fixed pattern but generated with a given amplitude when the OBs are created.

new observing constraint that limits how close to the evening twilight (the constraint is NOT applied to the morning twilight) their observations can be carried out, in addition to the usual ones (seeing, sky transparency, airmass, moon distance and fractional lunar illumination). This section reviews the new twilight constraints and the operational consequences from its application.

The time scale on which the sky brightness varies after the evening sunset and before the morning sunrise can be estimated from the plot³

in Fig. 14. Note that the time scale on the X-axis is in hours after sunset and before sunrise while while in P2PP3 the constraints sets must be specified in minutes after the end of the astronomical evening twilight (no constraint is applied to the morning twilight).

The following conclusions can be drawn from these plots:

- the *Z*, *Y*, *NB118*, and *J* bands suffer from the effect of the excitation of the OH sky lines until after 1.5–2 hr after the end of the twilight;
- the night-to-night variations are large, and they are comparable to the amplitude of the overall trend, even after one hour after sunset or before sunrise;
- the brightness of the sky is largely unaffected by the morning twilight.

Recommended twilight constraints for deep exposures are listed in Table 10. The users are free to optimize these parameters for their science cases.

The twilight constraints reduce the observability period of a target, and the effect can be important at the end of the observation period when the target is setting already at the beginning of the night. Eventually, the target could even be missed during the current observation period.

³From <http://casu.ast.cam.ac.uk/surveys-projects/vista/technical/sky-brightness-variation>

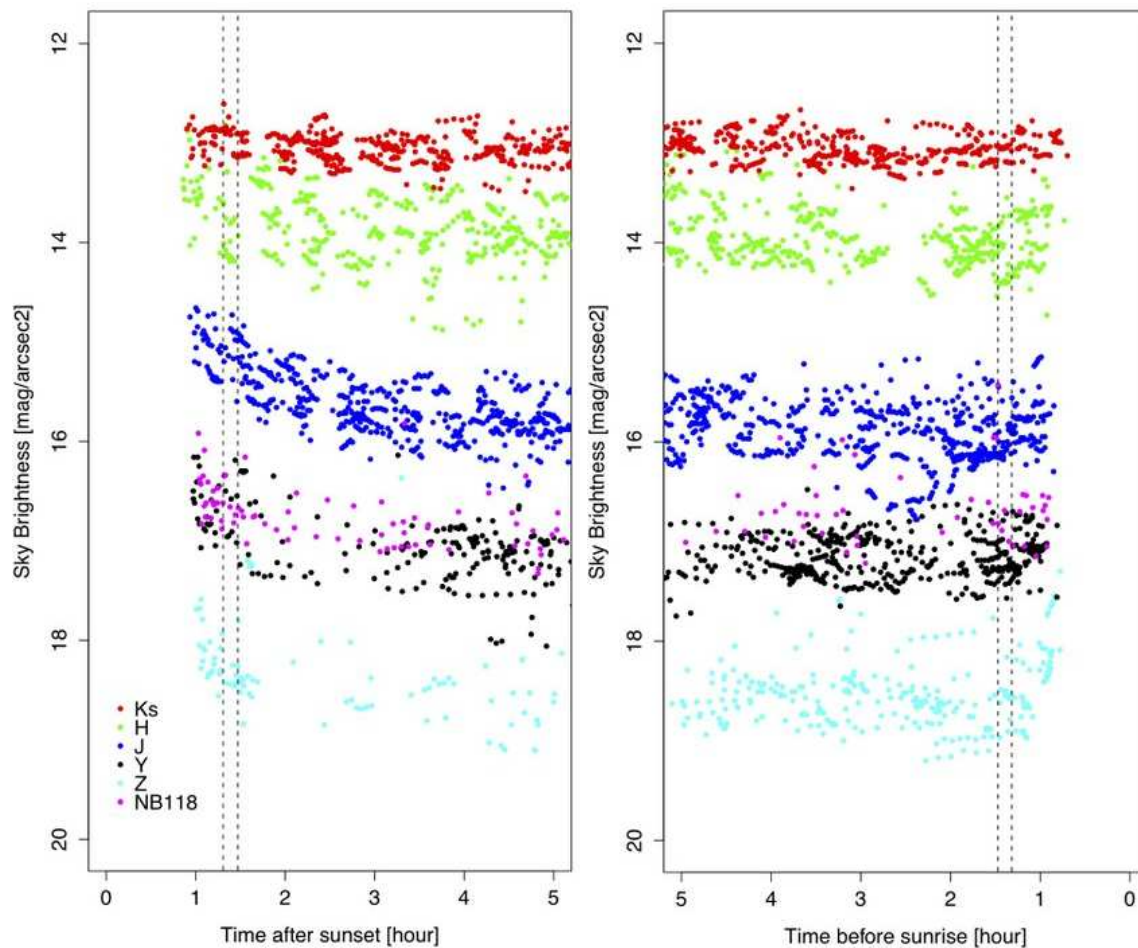

Figure 14: Evening (left) and morning (right) sky brightness variation. Only data from photometric nights have been used to make the plots. No constraints have been applied on the moon distance and the fractional lunar illumination, although the moon was always at least 30 deg away from the observed area. The dashed lines indicate the astronomical twilights. Courtesy of CASU.

Table 10: Recommended value ranges for the twilight constraints, for deep exposures. The values are in minutes after the end of the evening astronomical twilight. Negative values indicate that the observations can start within the evening twilight.

Filter	Minimum min	Maximum min
K_S	-60	-30
H	-30	0
$J, NB118$	30	60
Y	0	30
$Z, NB980, NB990$	-15	15

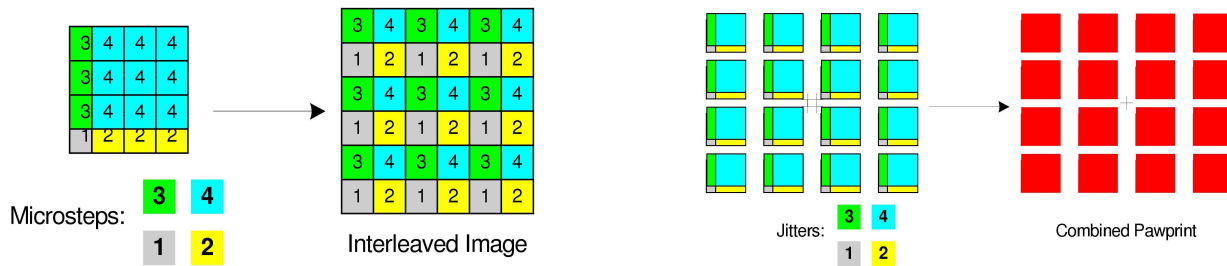

Figure 15: Combining exposures with microstepping (left) and jittering (right). Each numbered square corresponds to one pixel.

7.4 Pawprints, Tiles, Jitters, Microsteps

7.4.1 Definitions

This section describes a number of basic actions, that are used during the near infrared observations in general, and during the VIRCAM/VISTA operations in particular:

Integration - a simple snapshot, within the Data Acquisition System (DAS), of a specified elapsed time. This elapsed time is known also as the Detector Integration Time (DIT) and it is measured in seconds.

Exposure - the stored product in a file, **a sum (not an average!)** of many individual detector integrations, that have been co-added in the DAS. Each exposure is associated with an exposure time equal to $NDIT \times DIT$ sec.

Microstep (pattern) - a pattern of exposures (Figure 15, left) at positions each shifted by a very small movement (<3 arcsec) from the reference position. Unlike the jitter (see below), the fractional (i.e. non-integral) part of the shifts are specified as 0.5 pixel, which allows the pixels in the series to be interleaved in an effort to increase resolution. A microstep pattern can be contained within each position of a jitter pattern. **Note** that using the microstep pattern is currently discouraged due to problems with the data reduction because the data obtained with microsteps exhibit an artificial “hole” pattern.

Jitter (pattern) - a pattern of exposures (Figure 15, right) at positions each shifted by a small movement (<30 arcsec) from the reference position. Unlike a microstep (see above), the fractional (i.e., non-integral) part of the shifts is any fractional number of pixels. Each position of a jitter pattern can contain a microstep pattern. The jitter pattern can be pre-defined (fixed) or random. In the latter case, the user defines the jitter box width within which the offsets are made. The jitter box width parameter is ignored if a fixed jitter pattern is selected.

Pawprint - the 16 non-contiguous images of the sky produced by the VISTA IR camera, with its 16 non-contiguous chips. The name is from the similarity to the prints made by the padded paw of an animal (the analogy fits earlier 4-chip cameras better).

Tile - a filled area of sky fully sampled (filling in the gaps in a pawprint) by combining multiple pawprints. Because of the detector spacing the minimum number of pointed observations (with fixed offsets) required for reasonably uniform coverage is 6, which would expose each piece of sky, except for the edges of the tile, on at least 2 camera pixels.

The VIRCAM focal plane is sparse, i.e. there is significant space between the detectors. Therefore, a single integration of length DIT sec (or a co-added series of these known as an Exposure; it doesn't include moving the telescope between the individual DITs) produces a sparsely sampled image of the sky known as a Pawprint (in red in the following Figures). The area of sky covered by the pixels of a pawprint is ~ 0.6 sq. degrees. For comparison the fields of view of NICMOS, ISAAC,

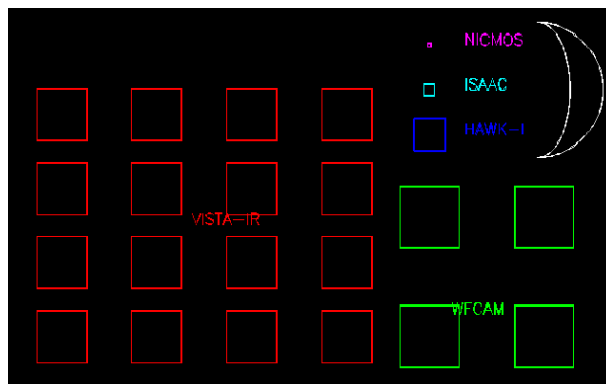

Figure 16: Comparison between the field of view of VIRCAM and other instruments.

HAWK-I and WFCAM are shown below in Figure 16, together with a crescent moon.

NOTA BENE: Recent tests (as of P85 on-ward) indicated that the VIRGO detectors do suffer from persistence. If your field contains bright stars **and the observations aim to add signal from several individual OBs of the same field**, the best strategy to minimize the persistence effects is to use random jitters or to use a different jitter pattern for every visit of the field. This strategy will assure accumulating many relatively short exposures at different offset positions! Note that the pattern can be modified either by selecting a different jitter pattern or by small modifications in the jitter scale multiplier parameter (see the Appendix).

7.4.2 “Filling-in” a tile with multiple pawprints

To “fill-in” the gaps between the detectors, or in other words, to produce a single **filled** Tile with reasonably uniform sky coverage, requires a minimum of six pointed observations (with fixed offsets). This is achieved first by observing at three positions offset in Y (Figure 17), i.e. so that after them an area with a vertical side 5.275 detector widths ($=4+3\times 0.425$) is covered at least twice. This corresponds to 1.017 deg (61 arcmin) at VISTA’s mean pixel size. There is also a strip at the top and another at the bottom which is only covered once by this tiling pattern. These strips are each 0.475 of a detector height, corresponding to 0.092 deg (5.5 arcmin) at VISTA’s mean pixel size.

Then, a position shift is made in X direction (Figure 18) so that the 2 positions in X cover a horizontal side of 7.65 detector widths ($=4+3\times 0.90+0.95$) with no strips at the $+/-X$ edges. This corresponds to 1.475 deg (88.5 arcmin) at VISTA’s nominal pixel size. Finally, the 3 steps in Y (described above) are repeated at the next position in X. So after $3\times 2=6$ steps an area of $5.275\times 7.65=40.354$ detector areas corresponding to $1.017\text{ deg} \times 1.475\text{ deg} = 1.501\text{ deg}^2$ sky is exposed on a minimum of 2 separate pixels, as shown in light green in the exposure time map below for a filled tile (no jitter). Some sky areas are exposed on more separate pixels (i.e., in the overlapping regions), and some areas are exposed on only one pixels (along the top and the bottom edge of the tile but the SADT makes sure that this is compensated by the neighboring tiles, providing another exposure for these areas). This issue is discussed below. Figure 19 demonstrates how the 6-offset pattern is combined into a tile.

The telescope movements used to assemble a tile out of six pawprints are made with respect to the X,Y coordinates in the camera focal plane, not with respect to the celestial coordinates. Therefore, pawprints are not tilted with respect to their neighbors (unless such a tilt is specifically introduced by the observer during the survey definition with the SADT; this is not straightforward but it can be achieved by defining individual tiles a separate survey areas, each with an individual position

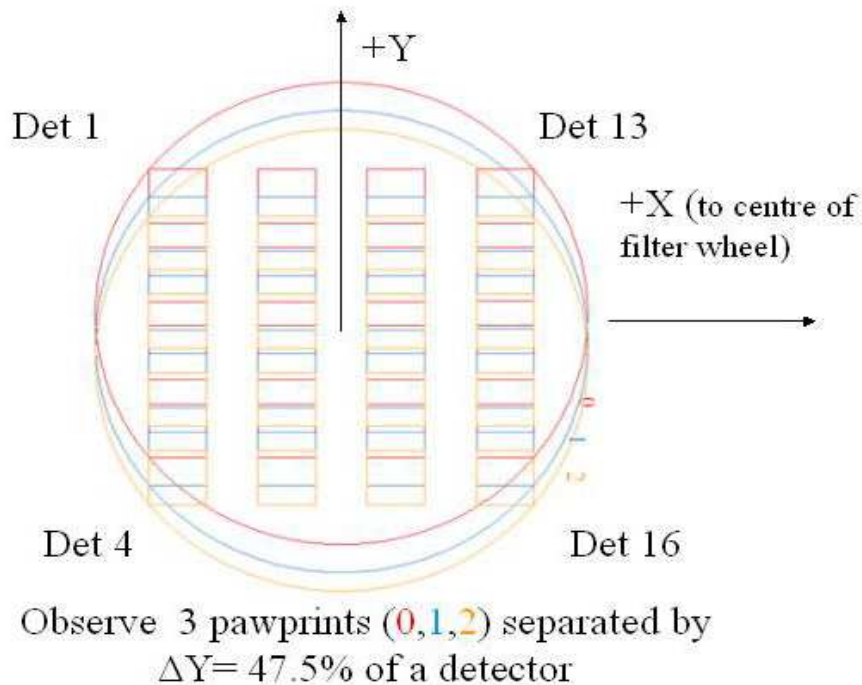

Figure 17: Completing a tile with six pawprints: the three vertical steps along the Y axis.

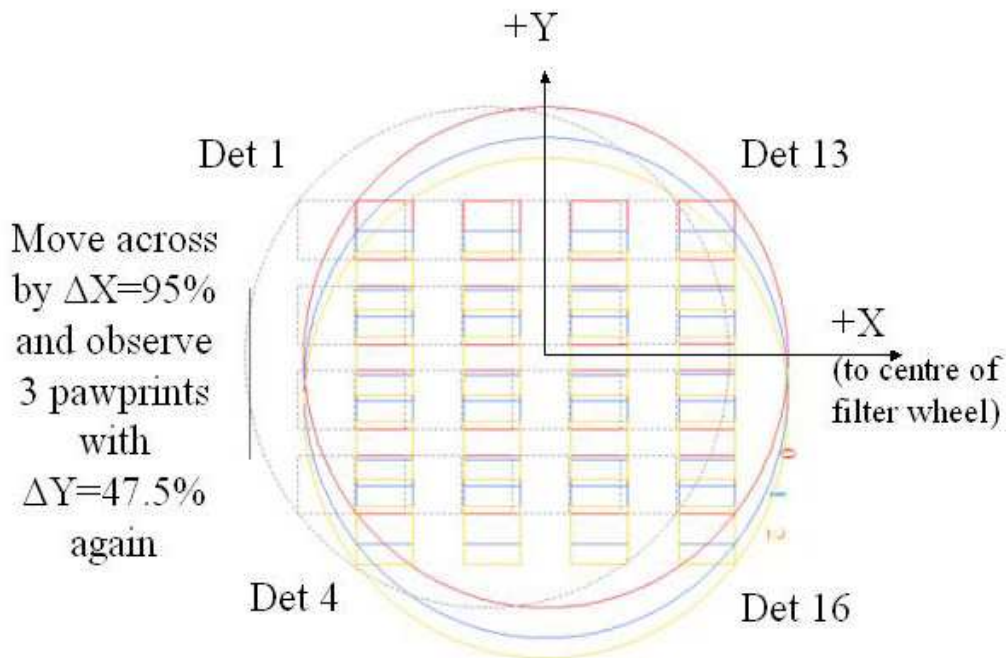

Figure 18: Completing a tile with six pawprints: the two horizontal steps along the X axis.

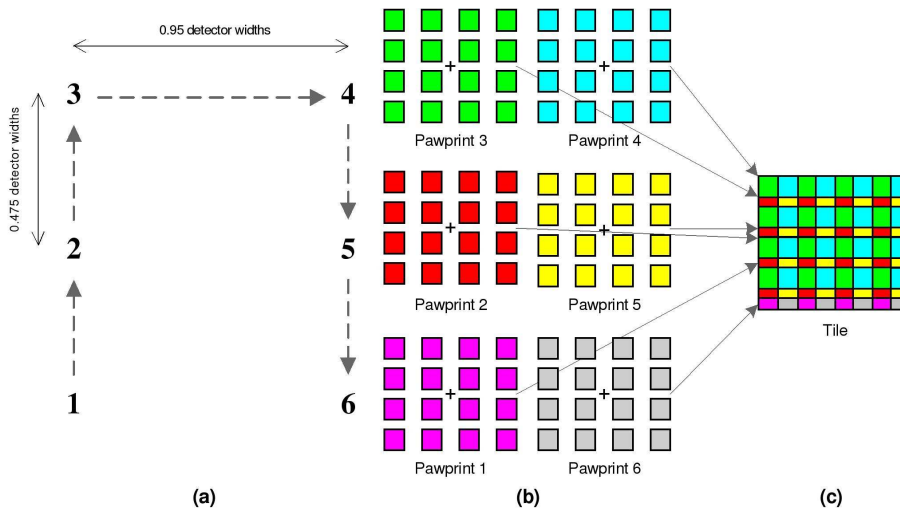

Figure 19: Contiguous tile, formed by combination of six overlapping pawprints.

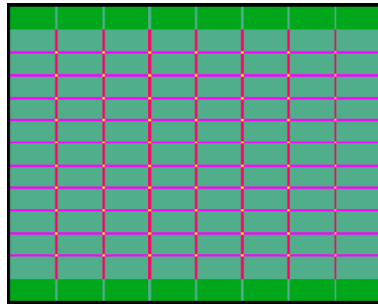

Figure 20: Exposure time coverage for a contiguous-coverage tile of 6 pawprints: dark green = 1, light green = 2, magenta = 3, red = 4, yellow = 6, in units of the single-pawprint exposure time.

angle). Relative tilts among neighboring tiles in a multi-tile survey will be present, especially near the celestial poles (Sec. 7.6).

A map, showing the integration times across the entire field of view, provided that the integration at each pointing is the same, is shown in Figure 20. The dark green areas at top and bottom of the plot are each $1.475 \text{ deg} \times 0.092 \text{ deg} = 0.135 \text{ sq. deg}$ and can be overlapped by corresponding areas from adjacent tiles for many surveys. Assigning only one of the two 0.092 deg overlap (top & bottom) to each of the two tiles involved in an overlap, the result is that each tile, when part of a filled larger area, would cover $(1.017 + 0.092) \times 1.475 = 1.636 \text{ deg}^2$ which will be covered at least twice.

7.5 Scheduling Containers

The survey nature of the VISTA operation implies executing a large number of similar or even identical OBs (except for the target coordinates), necessary to obtain uniform coverage of wide sky areas. This complicates enormously the short-term scheduling of observations because of the number of sometimes conflicting requirements: timing and weather condition constraints, uniformity, and last but not least - the requirement to complete a certain self-containing set of observations before starting a new one. A good strategic planning of a survey may ensure early science output long before the survey is completed.

A new P2PP3 has been developed by ESO that enables implementing a survey strategy called

scheduling containers. They are high-level tools, with respect to the jittering, microstepping, etc., described in the previous Sec. 7.4. The containers allow to streamline the operations giving at the same time enough flexibility to achieve the scientific goals of the surveys. Three types of scheduling containers are available:

- **Concatenations**: the member OBs are executed sequentially without interruptions, the order of execution is not specified; if any of the OBs in a concatenation is not executed, the entire concatenation must be repeated; the total execution time of the OBs in a container of this type can not exceed 1 hr

- **Time links**: the member OBs are scheduled whenever there is an upcoming time window defined by the users; the time windows are relative but after the execution of the first OB in a time link, they become absolute; a time link OB will not be observed at a later time if it cannot be executed within the required time interval;

- **Groups**: the member OBs may be executed depending on the needs of the flexible scheduling of the observatory, but the OBs in the respective groups are dynamically reassigned higher and higher priorities depending on the rate of completion of a group, to increase the probability that a group that has been started, is completed before other groups are started.

See the P2PP3 User Manual for a more detailed description of the scheduling containers.

7.6 Observing Strategy, Nesting

The observing strategy is determined by the science goals of the program, convolved with the limitations imposed by the technical characteristics and software features of the telescope and the camera. VISTA is a purpose-built survey telescope, so VIRCAM's primary function is to produce a contiguous map of large sky areas using overlapping exposures.

The starting point in the survey design is to select a balance between the area, the depth, and the filter coverage. Once this decision is made, the user should run the Survey Area Definition Tool (SADT) to determine the number of tiles necessary to cover the survey area. **Note that the tile pattern, selected in the SADT must not be changed in P2PP3 because the AO/AG reference stars selected in the SADT are suitable only for that tile pattern; they will not be valid for another tile pattern, and the change will cause the OB to fail during execution!** Next, comes the question of how to split the total integration time for each filter into different exposures, i.e. to select DITs, NDITs, microstepping and jitter patterns (see the discussion in Sec. 7.1.2). Finally, the user has to decide on the sequence in which the various observations will be obtained. For example, the filter rotation is relatively slow, (~ 21 -40 sec for a filter exchange; see Sec. 7.8) and it might be more efficient to combine the observations of a few nearby tiles in the same filter in one scheduling container *group* that will likely lead to their consecutive execution, rather than to change the filter, and to re-observe the same tile multiple times. However, this strategy may leave the user waiting for some time before the observations in all filters of each tile are collected, and it will not ensure nearly-simultaneous multi-band photometry. The order in which various filters are observed in a tile should be optimized to shorten the filter wheel movements (see Sec. 6.3 for the filter order). The individual steps in this sequence of decisions are intertwined, and often can not be separated as clearly as described in this example.

The “tile” is the basic unit of a survey, being the smallest contiguous area of sky that the camera can image. A contiguous survey covers the required sky regions by tessellating tiles together with a small amount of overlap. The contiguous sky coverage can require some tiles to be tilted with respect to their neighbors, especially near the celestial poles (Figure 21). The overlaps between neighboring tiles is a user-defined SADT parameter. Minimizing the overlaps makes the survey more efficient, but some overlaps are desirable because they provide repeated measurements that can be used to verify the internal astrometric and photometric self-consistency of the survey.

The process of defining an observing strategy for a survey is intentionally streamlined here. In fact,

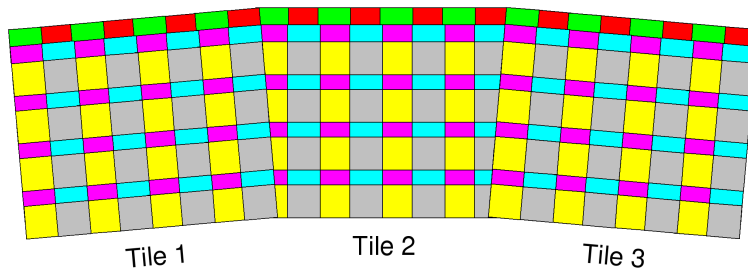

Figure 21: Example of a contiguous survey, containing three partially overlapping tiles. The curvature of the pawprint edges is ignored.

many steps may have to be iterated (i.e. the SADT re-run many times modifying the survey area) until an acceptable strategy is found.

The filter exchanges, pawprint patterns, jitter, and microstep offsets can be executed in different order, called **nesting sequence**. Three nesting sequences are implemented:

- **FPJME** : construct the tile from a series of pawprints, repeating each pawprint with a different science filter. Within each pawprint execute a jitter pattern (if specified), and within each jitter pattern execute a microstep pattern (if specified).

- **PFJME** : construct the tile from a series of pawprints. Within each pawprint execute a jitter pattern, only this time repeat each jitter with a different science filter before moving on to the next pawprint. Within each jitter execute a microstep pattern (if specified).

- **FJPME** : construct the tile from a pawprint and jitter pattern such that one jitter observation is made from each pawprint in turn. Within each pawprint position there can be a microstep pattern. The whole sequence may be repeated with different science filters.

The letters in these sequences stand for the following actions: **F** – set a filter, **P** – execute a pawprint offset, **J** – execute a jitter offset, **M** – execute a microstep pattern, and **E** – take an exposure.

If the user plans to observe with multiple filters within an OB, it is strongly recommended to combine multiple science templates in the OB (each with one filter), rather than to alternate between many filters in one template (via nesting). Following this suggestion will minimize the time loss in case of OB abort and restart.

The VISTA telescope system does not make any distinction between large movements (known at the VLT as “presets”) and small movements (known at the VLT as “offsets”), so the telescope movements made by an acquisition template or by one of the observation templates are just as efficient. The data acquisition efficiency would not have been improved, for example, by combining multiple tiles together in a single Observation Block (a feature that is not foreseen at the moment) as long as the OBs are scheduled efficiently.

A number of measures can be undertaken to improve the survey efficiency:

- use in the acquisition template the same filter as in the first science template, so the filter wheel movement is carried out in parallel with the telescope movement;
- minimize the filter movements in the science templates, if possible;
- use tile and jitter patterns which minimize the number of telescope movements, if possible;
- use the minimum total exposure time required for achieving the science goals of the survey;
- pull together into groups OBs with nearby targets on the sky, and with similar instrument set up to minimize telescope movements and instrument set ups; the re-prioritizing of the OBs in a started group will ensure that the telescope operator will execute first the rest of the OBs in the same group, before switching to another group;

The first and the last of the three nesting sequences might be the best suited for most VISTA programs because they ensure that all the observations in one filter will be carried back-to-back, so there will be more images taken close in time but at different pointings on the sky, suitable to construct a sky image.

Further suggestions may be added as more experience of observing with VISTA is accumulated.

7.7 Autoguiding and AO operation

The autoguiding and the wavefront sensing are fully transparent to the user during the observations. However, earlier during the definition of the survey, the user must define AG/AO stars with the help of the Survey Area Definition Tool (SADT). The SADT finds the minimal number of tiles, necessary to cover a user-defined survey area. For each tile the SADT verifies the presence of suitable stars in the LOWFS/AG field of view, and if this is not the case, it modifies the position of the tiles to ensure that such stars are available. The AG operation is not optional, having suitable guiding stars is mandatory.

During normal operations, usually once at the beginning of the night the HOWFS are used to implement initial corrections of the primary. Then, during the operation, the LOWFS are used, in parallel with the observations if the telescope stays at one position more than ~ 45 sec. This is the minimum time within which the LOWFS can provide correction. For more details on the wavefront sensing see Section 6.5 and 6.6.

7.8 Overheads

VISTA is intended to survey quickly, primarily through having a large field of view but as with any telescope there are overheads associated with observing. They depend on the adopted observing strategy. The overheads have to be taken into account when requesting time with VIRCAM, and the total allocated time includes both the exposure time on sky and the overheads.

To estimate the total execution time for an OB, one has to add to the total on-sky observing time the overheads for filter changes, microstepping, jittering, tiling, read-out overheads, as well as the overheads associated with the preset, the active optics and instrument set up. A summary of the VISTA and VIRCAM overheads is given in Table 11, and a more detailed description is given further. These numbers will be updated to reflect the real behavior of the system. For recent updates, check the ESO VISTA web page. An easy way to estimate the overheads associated with a typical OB is to use the P2PP3 tutorial account (username: 52052, passwd: tutorial).

A full preset includes:

- for a stand-alone (non-concatenated) OB or for the first OB in a concatenation the overhead is 120s. For the second, and subsequent OBs in a concatenation the overhead is equal to the altitude and azimuth slewing time of: $20 \text{ sec} + \text{target distance} / \text{slew speed}$, where the slew speed is 1 deg s^{-1} ;
- rotator offset is fast and it is usually completed during the telescope motion, so it adds no extra overhead;
- acquiring a guide star includes 3 s for guide star identification and 5 s for AG start;
- LOWFS observation to update the M2 position takes 45 s;
- instrument set up requires 0–40 sec depending on the length of the filter wheel movement.

VISTA is an alt-azimuth telescope so that the sequential presets between objects on the North and the South take long time and should be avoided, if possible. Therefore, the users should try to combine in a separate group OBs located North or South, to optimize the short-term OB scheduling. The Low Order Wavefront Sensor (LOWFS) is used to update the position of the secondary mirror

Table 11: VISTA and VIRCAM science observation overheads. Current and historical values are shown for completeness.

Action	Overheads, sec	
	P84-P86	P87
Preset (for a single non-concatenated OB)	~120	~120
Preset	~120	~120
GS handling	$20+(\text{distance, deg})/(1 \text{ deg s}^{-1})$	$20+(\text{distance, deg})/(1 \text{ deg s}^{-1})$
AG start	3	3
AO start	5	5
Filter change	45	45
Detector readout	21-40	21-40
Writing FITS to disk	2 per DIT	2 per DIT
Pawprint change	4	4
Jitter offset	10	15
Micro step	3	8
	4	4

during observations, and needs data for a minimum time of ~ 45 sec to smooth out seeing variations. The initial AO set up requires about 45 sec. Later on the LOWFS can operate in parallel with science observations. It takes ~ 45 sec for one closed-loop LOWFS cycle to complete and update the M2 position before science observing re-starts. Therefore, if the telescope stays in one position for >45 sec there is no extra LOWFS overhead but if the telescope moves more often than 45 sec, the user must choose between extra overheads to wait for the LOWFS or operation with somewhat degraded image quality. This choice is implemented with the “AO priority” parameter (see Sec. A.4). The filter change time depends on the wheel rotation angle from the last position. The time necessary to move between two:

- neighboring filters is 21 sec;
- filters separated by one position is 27 sec;
- filters separated by two positions is 33 sec;
- filters separated by three positions is 40 sec.

Larger offsets are not needed because they can be accomplished by a shorter movement of the wheel in the opposite direction. The filter changes can be done in parallel with the position change, to save time. The filter positions are listed in Table 7.

The science observations accumulate overheads for pawprint and jitter offsets, microstepping, detector readout, and storing the FITS files. Filter changes during the science observations (after the initial instrument set up for the OB) will add extra overheads. All these must be taken into account, and they are listed in Table 11.

7.9 Calibration Plan

There are four types of VIRCAM calibrations, related to:

- properties of the transfer function of the end-to-end system (telescope, camera, IR detector system including associated controllers, etc.) so that **instrumental signature can be removed from the data**. As VISTA has a wide field of view, particular attention must be paid to variations of the transfer function across the field;

- **photometric zero points and extinction coefficients** corresponding to the images. The expected accuracy is a few percent.
- **astrometric distortions** of the images; the nominal astrometric calibration is based on the 2MASS Point Source Catalog. 2MASS astrometry is derived from direct calibration to TYCHO2, and it is in the ICRS system (note that this requires RADECSYS = ICRS in the FITS headers). It is known to have average systematic errors smaller than ~ 100 mas and RMS errors smaller than ~ 100 mas, for all point sources with $S/N > 10$.
- generating **Quality Control measurements** for monitoring the instrument health and performance, and the weather conditions; for example, the FWHM of the stellar images verifies the instrument alignment, the quality of the AO correction, and the seeing conditions.

Generally, obtaining the necessary calibrations is a responsibility of the Science Operations Department. The users can only submit OBs for: (i) extra photometric standard star observations, (ii) observations of astrometric fields, and (iii) illumination correction, **if they require additional calibration data, i.e. obtained more frequently than envisioned by the calibration plan** (see Table 12). We list here the rest of the calibrations for completeness only.

The photometric standard star observations and the illumination correction images will be tagged as calibration by the data flow system, according to the parameters written in the fits header by the template. The astrometric fields will be tagged as science data. The pipeline will provide an astrometric solution for them as for all other science frames, based on the 2MASS.

7.9.1 Instrument signature removal

The aim of these calibrations is to provide pawprints as though taken with a perfect camera, which produces a photometrically linear, evenly illuminated, though sparsely sampled, reproduction of the sky, free of any instrument and detector defects. The calibration cascade is shown in Figure 22, and details of the individual calibrations are summarized in Table 12. Note that all calibrations must be repeated after an instrument intervention, regardless of the age of the last calibrations. They are processed by the corresponding pipeline recipes to produce either FITS file products, or systems of calibration coefficients. The raw output of all calibrations are one or more fits files or fits tables.

Summary of the calibration data:

(1) Reset Frames measure the variation of the reset calibration is a Reset-Read sequence taken with the minimum DIT plus the 5-8 sec overheads during which the IRACE processes an integration and starts the next one. A typical sequence might be 5×10 sec exposures. Note that this is different from a dark frame, which consists of a Reset-Read-Read sequence where the output is the difference of the two reads. The aim here is to map the effect of the reset and to trace any drift of the pixel level after a reset, so each new reset frame is compared with a historical one from a database to detect changes. The pipeline output is a variance with respect to the “standard” frame (a QC parameter).

(2) Dark-Current Frames are dark frames taken with increasing DITs, used to measure the detector dark current by fitting a median slope to dark values versus DIT for each pixel, to produce a dark-current map. The range of DITs starts at MINDIT (currently 1.0011 sec), and finishing at a large value, depending only on the available time for this calibration. The pipeline outputs calculates an array of detector dark currents for each individual pixel (a QC parameter).

(3) Dark Frames are exposures with cold blank filters completely blocking the detectors from incoming radiation. They are used to calibrate out and measure two separate additive effects: (i) the thermal dark current, and (ii) the “reset anomaly” (a residual structure left in the image after the reset is removed in the DAS, when it does a correlated double sample Reset-Read-Read).

They are additive and can be removed together, using dark frames taken with **the same DIT×NDIT as the observation that need to be calibrated (note that the NDIT also must be the same because the final frame is the sum – not the average – of the individual DITs)**, assuming that the two effects are stable on the time scale of the length of the exposures. Usually, for astronomical detectors they are stable on the time scale of days. To minimize contamination from transient events, the darks are combinations of many frames with appropriate rejection.

The total duration of the calibration depends on the number of DIT×NDIT combinations that need to be calibrated – one set of calibrations must be taken for each set of observations. The pipeline

Table 12: Summary of the calibrations. The columns contain: type of calibration, phase of the observations when the calibration is obtained, frequency of repetition, approximate duration of the calibration, templates used to obtain the calibration, and the pipeline recipe used to process the calibration data. The duration of flats for narrow band filters is longer than the given numbers because of the lower transmission. The duration of the persistence and the cross-talk depends on the presence of bright stars in the field and may be longer if there are not enough of them to cover all detectors. The less-frequent calibrations taken on weekly or monthly basis will also be taken upon request by the CASU, if and when they are needed. Some calibrations are determined continuously from the science data (i.e., the 2MASS based illumination correction), as opposed to others that are measured only as needed.

Calibration	Phase	Freq.	Duration	Template	Pipeline Recipe
Calibrations for instrument signature removal:					
Reset Frames	Daytime	Daily	2 min	VIRCAM_img_cal_reset	vircam_reset_combine
Dark-Current Frames	Daytime	Weekly	10 min–2 hr	VIRCAM_img_cal_darkcurrent	vircam_dark_current
Dark Frames	Daytime	Weekly	10 min–2 hr	VIRCAM_img_cal_dark	vircam_dark_combine
Detector Noise	Daytime	Monthly	1 min	VIRCAM_img_cal_noisegain	vircam_detector_noise
Linearity, Readout noise, gain	Daytime or cloudy night	Monthly	1 hr/filter	VIRCAM_img_cal_linearity	vircam_linearity_analyse
Dome Flats	Daytime	Weekly	0.3 hr/filter	VIRCAM_img_cal_domeflat	vircam_domeflat_combine
Twilight Flats	Twilight	Weekly	15 min/filter	VIRCAM_img_cal_twiflat	vircam_twilight_combine
Calibrations for photometric standard star observations:					
Standard star	Night	Nightly	~3 min/filter (1 per night)	VIRCAM_img_cal_std	vircam_standard_process
Calibrations for astrometric distortions:					
Astrometric Correction	Night	Nightly	in parallel	all science templates	vircam_jitter_microstep_process
Calibrations derived from the science data:					
Night-Sky Maps	Night	Contin.	in parallel	N.A.	vircam_jitter_microstep_process
Sky Subtraction & Defringing	Night	Contin.	in parallel	N.A.	vircam_jitter_microstep_process
Jittering Offsets	Night	As needed	in parallel	VIRCAM_img_obs_paw, VIRCAM_img_obs_tile	vircam_jitter_microstep_process
Microstepping	Night	As needed	in parallel	VIRCAM_img_obs_paw	vircam_jitter_microstep_process
Opt. Distortion	Night	Contin.	in parallel		
WCS Fit	Night	Contin.	in parallel		vircam_jitter_microstep_process

outputs are a mean dark fits frame and some QC parameters (dark current signal plus reset anomaly stability measurement, detector dark current, and detector particle event rate).

(4) Dome flats are used for instrument performance monitoring, and evaluation of the image structure. **They are not used for gain correction (flat-fielding) due to non-uniform illumination of the screen, and the different colour of the illumination compared with the night sky.** The dome flats are a series of timed exposures of the dome screen taken through a given filter, in conditions that exclude variable or excessive ambient light (i.e., no working in the dome during the dome flats). The illumination/exposure times are adjusted to yield $\sim 8,000$ ADU (i.e. a fraction of the potential well depth of 36,000 ADU). The pipeline outputs are: a master dome flat for the given filter, bad pixel mask, and a number of QC parameters (number of saturated pixels, lamp efficiency, etc.)

(5) Detector Noise calibration – measures the readout noise and the gain of each chip, for purpose of detector health monitoring. The measurement uses a pair of dome flats, and a pair of darks matching the $\text{DIT} \times \text{NDIT}$ of the flats. The flats must be exposed to give $\sim 8,000$ counts. The pipeline calculates readout noise and gain for each read-out channel of each detector (QC parameters). Later on, these values are used by the pipeline in some pixel rejection algorithms, i.e. during the combination of individual jittering science frames.

(6) Linearity curve of each detector can be determined through a series of ~ 20 dome flats taken under constant illumination, at varying exposures, starting at MINDIT, up to just into saturation for all chips. The illumination is set to produce ~ 1000 ADU at MINDIT.

The constant screen illumination requirement implies that the dome flats cannot be taken in conditions of variable or excessive ambient light, i.e. no work in the dome is allowed during the linearity calibration. Check frames of constant exposure are intertwined with the “ramp” exposures to monitor the screen illumination. The dome lights are typically stable within 1% level. Alternate runs of this procedure should use increasing and decreasing sets of exposure times or take exposures with different exposure times in a randomized non-monotonic order. The pipeline calculates linearization curves and polynomial coefficients, bad-pixel maps, and various QC parameters such as measurement of non-linearity, and bad pixel statistics.

(7) Twilight Flats remove pixel-to-pixel gain variations and the instrumental vignetting profile for a given filter. They also provide a global gain correction between the 16 detectors and between the 16 individual read out channels within each detector (giving a total of 256 channels). The mean flat-fields and bad-pixel maps are sources for the confidence map that are part of the final science-level data products. These confidence maps are in effect combined weight maps where the mean level is normalized to 100%, and bad pixels are set to zero - an important pre-requisite for the deep stacking and tiling of the individual pawprints, and for calculating the statistical significance of detected objects.

Twilight sky flats have a good (but not perfect) colour match to the night sky observations we wish to correct, and can be taken under conditions where the contribution from night sky fringing, emission from dust particles on the optical surfaces, and other spatial effects are mostly negligible or match best the conditions for the science data. The slightly imperfect colour match between the twilight and night sky will cause a very small residual error in the gain correction.

The sky level must be low enough to avoid saturating a MINDIT exposure, but high enough so the emission from fringing or dust on the optical surfaces will be negligible in comparison with the sky level, leaving only a short interval in which to acquire the twilight flats. Therefore, it will not always be possible to get a complete set of twilight flats every night, especially during service observations using many filters or on cloudy nights. Pre-selected “empty” twilight fields will be observed on **clear** nights, and offsets between the individual exposures will be executed to cancel the effect of bright stars in the field. The pipeline output includes mean twilight flats, confidence maps, and ratios with respect to a reference flat for all detectors and channels (QC parameters).

(8) Image Persistence (or “remanence”, “memory”) is a detector feature causing residual traces of images from a preceding exposure on the current image. It is measured observing a fairly empty

field (to avoid confusion with the cross-talk effects) with a close to saturated star, followed by a sequence of dark frames to measure the characteristic decay time of the remnant from the star. This must be done for each detector or even for each readout channel. The pipeline product is a set of persistence constants.

It was thought until mid-2010 that the persistence of VIRGO detectors is negligible but the data reduction eventually demonstrated that this is not the case. The persistence is nearly impossible to correct if it is caused by saturated objects. Therefore, the faux sources caused by this effect will eventually be flagged but there will be no attempt to correct it. Please, check the VISTA web page for updates.

The users are strongly advised to take their data via as many different jitter offsets as possible, especially if they plan to accumulate signal during multiple visits of the target (in other words, splitting the observation between many OBs). This is easiest to achieve with random jitter offsets or alternating the jitter pattern for every visit of the target, as mentioned in Sec 7.4.1.

7.9.2 Photometric Calibration

The IR window between 1 and 2.5 microns contains several large absorption features that are primarily due to water vapor and carbon dioxide in the atmosphere. The edges of the atmospheric windows are highly variable. Although the infrared filters are designed to exclude the regions affected most, for some filters, in particular K_S , the edges of the useful passbands are defined by these absorption features rather than the transmission curves of the filters themselves. Thus, when the column density of water vapor is variable, accurate photometry can be difficult to achieve. On good nights (generally when the humidity is low and it is cold) it should be possible to achieve better than 1% absolute photometry; however, on most nights this should be considered as the best limit and the typical accuracy is 3-5%. Of course, the relative photometry can be much more accurate. Good planing of the observations and sophisticated data reduction (i.e. image subtraction instead of aperture photometry and PSF fitting) has allowed some users to achieve on a 4-m class telescope relative photometry of a few millimagnitudes!

The camera will be on the telescope semi-permanently, providing a stable configuration that enables us to take a long-term approach for the photometric calibration. The strategy is to define robust routine calibration procedures, so that the accuracy, and hence the scientific value, of the archived survey observations, will be maximized. The ultimate goal is to provide a photometric calibration accurate to $\sim 2\%$. This value may change with time, check the VIRCAM web page for more up to date information.

Zero points – defined as magnitudes at airmass unity which yield flux of 1 count/sec on the detector – will be determined in the Vega system via two independent methods:

(1) Calibration from 2MASS: The 2MASS will provide directly the initial photometric calibration for J , H , and K_S . The Y and Z bands have no 2MASS counterparts but Hodgkin et al. (2009, MNRAS, 394, 675) demonstrated that it is possible to calibrate them within the requirements of the calibration plan using the 2MASS J band and the $J-H$ color as long as $E(B-V) < 0.2$ and $E(B-V) < 1.5$ mag, respectively for Z and J .

The 2MASS photometric system is globally consistent to within 1% (Nikolaev et al. 2000, AJ, 120, 3340). This approach will enable each detector image to be calibrated directly from the 2MASS stars that fall within the field of view. The experience with WFCAM indicates that this approach will result in a photometric calibration to better than 2% for VIRCAM. Note that the 2MASS-based calibration can rely on a relatively narrow dynamic range because the 2MASS is shallower than the typical VISTA surveys, and the 2MASS photometric errors are relatively large near the 2MASS limiting magnitude. For example, at $K_S \sim 15$ mag, the uncertainty is usually 0.15-0.2 mag. At the same time, the larger VISTA telescope size leads to saturation of the brighter stars, so typically, the useful magnitude range is limited to 12-14 mag in all bands.

The photometric zero point is derived individually for each image from measurements of stars in the 2MASS Point Source Catalog (PSC) by solving the equation for each filter and detector:

$$ZP_{VIRCAM} + m_{instr} - m_{2MASS} = CT(J - H)_{2MASS} + const \quad (1)$$

for all common stars above a threshold signal-to-noise in the PSC and unsaturated in VIRCAM. Here ZP_{VIRCAM} is the VIRCAM zero point, $m_{instr} = -2.5 \times \log_{10}(counts/sec)$ is the VIRCAM instrumental magnitude, m_{2MASS} is the 2MASS PSC magnitude, $(J - H)_{2MASS}$ is the 2MASS PSC star color, and $const$ is an offset which may be required to transfer some passband to the Vega system.

The 2MASS-based photometric calibration is the primary calibration strategy for VISTA.

(2) Calibration from Standard Star Fields. A small fraction of the VISTA observing time is devoted to observations of standard stars. The evening and morning twilights will be used for taking photometric calibration data: as a rule we will observe a faint UKIRT standard in ZYJ in the evening (useful also for measuring the sky brightness), and if some time remains at the end of the night, that can not be filled in with science observations, we will observe additional standard(s) in all broad band filters (including standards at high airmasses). The 2MASS Touchstone Fields will be observed if the UKIRT standards are not available, i.e. due to wind pointing restriction. These data will provide important information on the stability of VIRCAM, and will be used to measure any intra-detector spatial systematics (i.e. illumination correction).

For any standard star i in any filter b :

$$m_{ib}^{cal} = m_{ib}^{instr} + ZP_b - k_b \times (X_i - 1) \quad (2)$$

where m_{ib}^{cal} is the calibrated instrumental magnitude in the system of the standard star, $m_{ib}^{instr} = -2.5 \times \log_{10}(counts/sec)$ is the measured instrumental magnitude, ZP_b is the Zero Point, k_b is the atmospheric extinction coefficient, and $X_i = \sec z_i$ is the airmass of the standard star during the observation. It is assumed here that the second-order atmospheric extinction term and the colour-dependency of k_b are both negligible.

Typically, ZPs are stable throughout a night (if photometric), but over months the ZPs decrease (i.e. the sensitivity of the instrument is reduced), for example due to accumulation of dust on the primary mirror. The extinction coefficients k_b are usually stable over periods of months but they will be monitored through each night assuming fixed ZPs and making measurements over a range of airmasses. The 2MASS found that their extinction coefficients vary seasonally but such an effect should be smaller for VISTA because of the drier site and narrower filter profiles, especially at J .

A network of secondary photometric standard fields is set up allowing routine photometric standard observations.

The standard fields are selected among the UKIRT faint standard fields and 2MASS Touchstone Fields (Figure 23). Many of them have already been observed and calibrated by WFCAM at the UKIRT. Note that the UKIRT standards do have Y and Z band measurements. In the interest of time, we only observe them on detector No. 11.

The secondary fields meet the following criteria:

- (1) cover the camera pawprint area;
- (2) span RA=0–24 hr, with an approximate spacing of 2 hrs
- (3) enable observations over a range of airmass, i.e. some fields pass close to the VISTA zenith, and others are available to the North (to allow for WFCAM cross-coverage) and South to optimize telescope azimuth slewing and to allow observations during strong wind from different directions;
- (4) contain ~ 100 stars per detector to allow characterizing the systematic position-dependent photometric effects (but avoiding crowding problems), with $J \leq 18$, and $K_S \leq 16$ mag for short exposures;
- (5) encompass stars with broad ranges of colours to allow derivation of extinction colour terms and to facilitate transformations from/to other filter systems.

Photometric Standard Field Calibration is obtained with a template (Table 12) that sets the header DPR parameters so the pipeline can identify the raw fits files as standard star observations, and to process them accordingly. The pipeline output is: ZP, atmospheric extinction coefficient, extinction color term, illumination correction, and a global gain correction.

7.9.3 Astrometric Calibration

The astrometric calibration provides the transformation between pixels coordinates of instrument-signature free pawprints and celestial coordinates for all 16 sub-images, leaving the pawprints on the appropriate photometric scale. The transformations are saved in a Flexible-Image Transport System (FITS) World-Coordinate System (WCS) header parameters. Zenithal Polynomial Projection (ZPN) is used (Calabretta & Greisen 2002, A&A, 395, 1077).

There is a measurable variation of the pixel scale across the field of view: from 0.3363 to 0.3413 arcsec px⁻¹ along the X-axis, and from 0.3351 to 0.3413 arcsec px⁻¹ along the Y-axis, based on data from 2009-01-26 (Fig.24). Given the physical pixel size of 20 μm, these translate into physical scale variations 58.60–59.47 μm arcsec⁻¹ and 58.60–59.68 μm arcsec⁻¹, respectively. As can be seen from the plot, the strongest term in the optical-distortion model is the (cubic) radial one. The true on-sky radial distance r' from the optical axis is related to the measured radial distance in the focal plane r as:

$$r' = k_1 \times r + k_3 \times r^3 + k_5 \times r^5 + \dots \quad (3)$$

where $k_1 \sim 0.34$ arcsec px⁻¹, $k_3 \sim 42 \times k_1$, $k_5 \sim -10000 \times k_1$, and higher order terms seem to be negligible. The rms of the residuals from individual detector linear fits to the 2MASS RA and Dec, after the distortion correction, are ~ 100 miliarcsec, and they seem to be dominated by the 2MASS coordinate errors. The distortions are wavelength (i.e. filter) dependent.

It is necessary to remove the distortion before combining images taken at different jittering positions by means of non-linear pixel re-sampling. The radial scale variation due to the distortion has also an impact on photometric measurements, inducing an error of up to 3.5% in the corners of the field, compared with the center.

The WCS distortion terms are measured from on-sky observations, based on the 2MASS PSC astrometry, in the system of the International Coordinate Reference Frame (ICRF). The astrometric calibration is carried out in parallel with the observations and doesn't require dedicated time (Table 12).

The camera software writes initial WCS parameters values into the FITS headers of each raw data frame based on the guide star position. The accuracy is better than 2 arcsec, and it depends on the guide star coordinates accuracy, and the accuracy with which the camera geometry is known. After the instrumental-signature removal the pipeline uses this initial approximation as a starting point for orientation of the data frames and location of astrometric stars for a full WCS solution that provides refined scientific quality astrometry. The astrometric stars are centroided in the data frames to typically 0.1 pixel accuracy. The uncertainty of the final astrometric solution comes from the RMS of the fit, and the known systematics of the reference catalog.

The pipeline output includes refined WCS FITS header parameter values for all frames, and some QC parameters (i.e. pointing accuracy, calculated from equatorial coordinates computed at the particular location using the fitted WCS and the initial WCS that was written to the raw header).

7.9.4 Additional Calibrations Derived from Science Data and Related Observing Strategies

The procedures described in this section and summarized in Table 12 are calibrations only in a broader sense – they are rather data reduction steps, related to the astrometric calibrations of the data. They are derived from raw data FITS files during the regular data flow, i.e. do not require

dedicated observations and extra overheads. Their purpose is to remove the instrument-signature, i.e. the sparse sky coverage of the individual pawprints or the cosmetic defects of the detectors.

(1) Sky Subtraction and Defringing removes the well known sky background variations over large scale in the IR, and the fringing and thermal emission from local dust particles on the optical surfaces. The sky maps are formed either from the target frames (if the target field is sparse) or from any special offset sky frames (for crowded fields or extended targets) by combining frames over an appropriate time range (determined by the sky flat stability), with appropriate rejection. The pipeline also produces fringe and dust maps.

(2) Dark Sky Flats may be constructed from the dark sky maps. Their advantage over twilight flats is the better colour match to the average astronomical object, minimizing the sensitivity of the gain and flat-field correction to differential colour terms with respect to astronomical objects. However, fringing and thermal emission from dust particles on the optical surfaces need to be removed because they can be high enough to affect the background significantly in some passbands, leading to systematic errors in photometry.

(3) Jittering removes detector cosmetic defects and cosmic ray hits, and allows to create sky maps, while accumulating sufficient signal to achieve the required S/N. The flat fielding is also improved because the flux coming from a given point on the sky is averaged over the response of many different pixels. For jittering, the total requested exposure is split into several shorter exposures (at least 5, to obtain good sky maps) with random or predefined telescope offsets between them. It is similar to microstepping, but with coarser sampling, and the pipeline combines the jittered exposures with a rejection algorithm. The pipeline combines the jittered frames, after removing the other instrument signatures, and produces a combined frame and confidence maps.

(4) Microstepping improves the sampling by *non-integer sub-pixel offsets*. It can make a difference when the point-spread function is under-sampled (for seeing better than 0.68 arcsec). It improves the flat fielding, same as jittering. Unlike the jittering, the pipeline interleaves the microstepped exposures without rejection. There is a number of predefined microstepping patterns (i.e. 2×2 pattern, with 0.5 pixel spacing). Microstep patterns can be nested within each jitter position. The pipeline combines the microstepped frames and produces confidence maps. **Note** that using microsteps is currently discouraged due to data reduction difficulties.

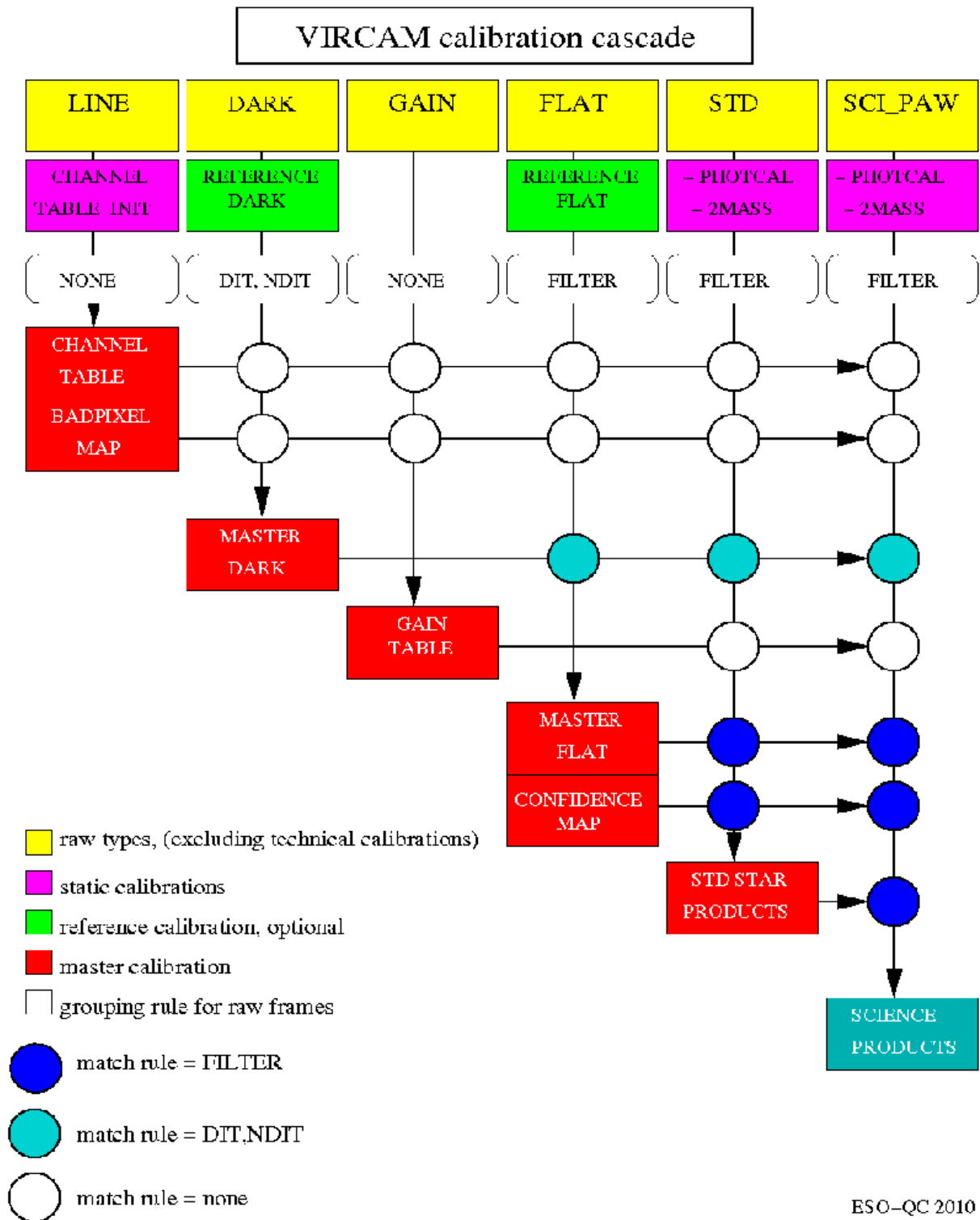

Figure 22: VIRCAM cascade diagram for producing calibration frames.

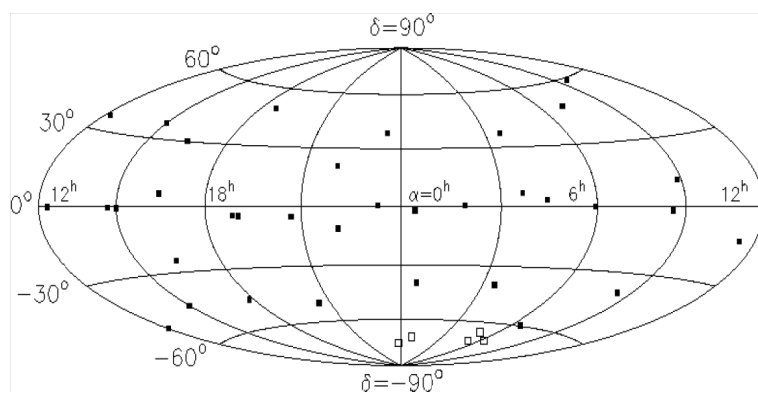

Figure 23: Distribution of the 2MASS touchstone fields on the sky.

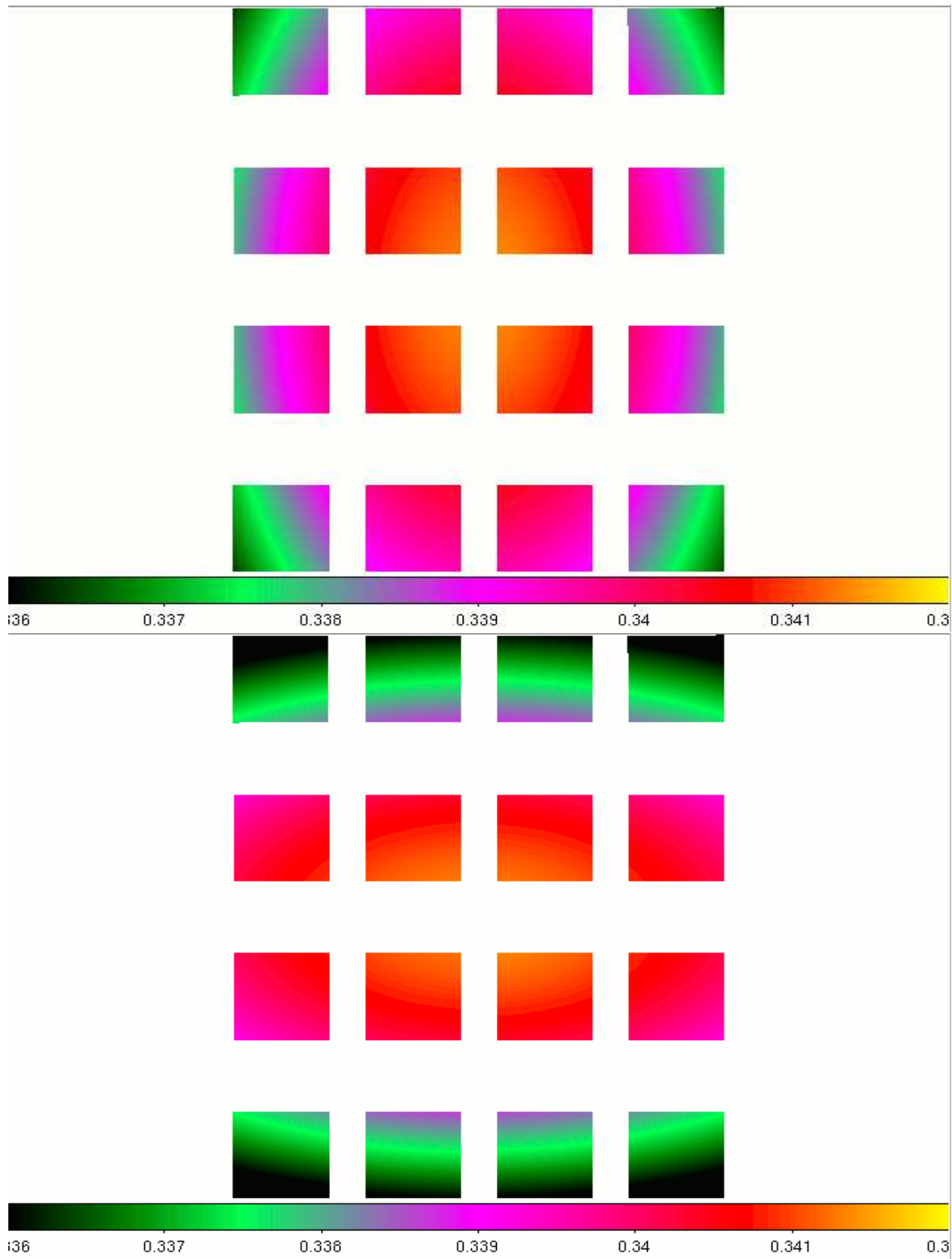

Figure 24: Maps of the pixel sizes across the focal plane, along the X (top) and Y (bottom) axis. Based on data from 2009-01-26.

8 Data Flow, Pipeline, Quality Control

The mean VISTA data volumes per night are exceptionally high (estimated $\sim 150\text{-}300$ GByte on a typical night) because of the multiple short exposures, usual for IR observations. This makes it challenging to reduce the data at the telescope, or even to carry out fully just the primary data reduction (sky subtraction, flat fielding). Only partial processing is carried out at the telescope, for preliminary quality control purposes.

The data are transferred first to the ESO archive in Garching where a copy is made and sent to CASU. The nominal delivery time is a few hours. Calibration data are processed at ESO by the ESO pipeline to create master calibrations, and uses them for higher level quality control and trend analysis. These reductions are limited. Further data reduction is carried out by the users outside of ESO, either at CASU or by the efforts of the survey teams themselves. Immediately after the data pass quality control, the raw frames become publicly available, either via the ESO Archive, or via the WFAU. Finally, after reducing and analyzing the data, the users can upload high-level data products into the ESO Archive to make them available to the community via dedicated tools.

The object extraction is vital for astrometric and photometric calibrations of the data, and it is rigorously monitored during the quality control process. The pipeline extracts objects from each frame, and classifies them as stellar, non-stellar or noise. A number of QC parameters are associated with every object: mean sky background, mean sky noise, number of noise objects, mean seeing, mean stellar ellipticity, etc. The quality control (QC) adds no overhead to the observations. A number of QC parameters are written in the fits headers of the files by the CASU pipeline. A list of QC parameters is given in Table 13).

ESO does not distribute a dedicated pipeline for VIRCAM data reduction to the user community. All VISTA data available from the archive immediately following observations are **raw**. The Public Survey teams have the obligation to return to ESO the reduced images and catalogues of the detected sources, reduced images, and other survey-specific high level data products. This is done as part of the Phase 3, which is mandatory for the public surveys (but not for the the normal programmes).

ESO does not reduce the VIRCAM science data. The users should therefore either develop their own data reduction procedures or get in touch with CASU. CASU receives all VISTA data, and they typically process all with the standard VISTA pipeline (via processing that is roughly described in this manual). However, CASU has no obligation to deliver the reduced data to the general ESO telescope users – this can be done but it is not guaranteed. CASU reduces the data upon agreement with the Survey Teams. Instead, the general users have free access to the Phase 3 products delivered by the Survey Teams to ESO, via the ESO Science Archive.

A good source of technical information on the CASU data processing is:

<http://casu.ast.cam.ac.uk/surveys-projects/vista/technical>

Up to date information about the progress of the data processing can be found at:

<http://apm49.ast.cam.ac.uk/surveys-projects/vista/data-processing>

Table 13: Quality Control Parameters.

Parameter, units	Description
QC.APERTURE_CORR [mag] 2 arcsec diameter aperture flux correction.	The aperture flux correction for stellar images due to flux falling outside the aperture. Determined using a curve-of-growth of a series of fixed-size apertures. Alternative simple measure of image profile properties, particularly the presence of extended PSF wings, as such monitors optical properties of system; also required for limiting magnitude computations.
QC.BAD_PIXEL_NUM Number of bad pixels/detector.	Determined from the statistics of the pixel distribution from the ratio of two flatfield sequences of significantly different average count levels. The number of bad pixels per detector (hot or cold) should not change.
QC.BAD_PIXEL_STAT Fraction of bad pixels/detector.	Determined from the statistics of the pixel distribution from the ratio of two flatfield sequences of significantly different average count levels. The fraction of bad pixels per detector (either hot or cold) should not change.
QC.CROSS_TALK Average values for cross-talk component matrix.	Determined from presence of +ve or -ve ghost images on other channels/detectors using exposures in bright star fields. Potentially a fully populated 256x256 matrix but likely to be sparsely populated with a small number of non-zero values of band-diagonal form. This QC summary parameter is the average value of the modulus of the off-diagonal terms. Values for the cross-talk matrix should be very stable with time, hardware modifications notwithstanding.
QC.DARKCURRENT [ADU sec ⁻¹] Average dark current on frame.	Measured using the median of the pixel values, can later be compared with older darks for trends.
QC.DARKDIFF_MED [ADU] Median new-library dark frame.	Measure the median of the difference of a new mean dark frame and a library dark frame.
QC.DARKDIFF_RMS [ADU] RMS new-library dark frame	Measure the RMS of the difference of a new mean dark frame and a library dark frame.
QC.DARKMED [ADU] Median dark counts	Median counts in a dark frame.
QC.DARKRMS [ADU] RMS noise of combined dark frame.	RMS is defined here as the Gaussian equivalent MAD i.e. $1.48 \times$ median-of-absolute-deviation from median. The RMS can later be compared with library values for darks of the same integration and exposure times.
QC.ELLIPTICITY Mean stellar ellipticity.	The detected image intensity-weighted second moments will be used to compute the average ellipticity of suitable signal-to-noise stellar images. Shot-noise causes even perfectly circular stellar images to have non-zero ellipticity but more significant values are indicative of one of: optical, tracking and auto-guiding, or detector hardware problems.
QC.FLATRATIO_MED Median new/library flat ratio.	Measure the median of the ratio of a new mean flat frame and a library flat frame.
QC.FLATRATIO_RMS RMS new/library flat ratio.	Measure the RMS of the ratio of a new mean flat frame and a library flat frame.
QC.FLATRMS_RMS flat- field pixel sensitivity per detector.	RMS is defined here as the Gaussian equivalent MAD i.e. $1.48 \times$ median-of-absolute-deviation from unity after normalizing by median level i.e. measuring the RMS sensitivity variation. The RMS can later be compared with library values for troubleshooting problems.
QC.FRINGE_RATIO Ratio of sky noise before/after fringe fit	A robust estimate of the background noise is done before the first fringe fitting pass. Once the last fringe fit is done a final background noise estimate is done. This parameter is the ratio of the value before fringe fitting to the final value after defringing.
QC.GAIN [e ⁻ /ADU] Gain.	Determined from pairs of darks and flatfields of the same exposure/integration time and illumination by comparing the measured noise properties with the expected photon noise contribution. The gain of each detector should remain stable so long as the electronics/micro-code have not been modified.

Parameter, units	Description
QC.GAIN_CORRECTION Detector median flat-field/global median.	The ratio of median counts in a mean flat exposure for a given detector relative to the ensemble defines the internal gain correction for the detector. These internal relative detector gain corrections should be stable with time.
QC.HOTFRAC Fraction of hot pixels	The fraction of the pixels on an image that are estimated to be hot.
QC.IMAGE_SIZE [arc-sec] Mean stellar image FWHM.	Measured from the average FWHM of stellar-classified images of suitable signal-to-noise. The seeing will obviously vary over the night with time, wavelength (filter) and as airmass ^{0.6} . This variation should be predictable given local site seeing measurements. A comparison with the expected value can be used as an indication of poor guiding, poor focus or instrument malfunction.
QC.LIMITING_MAG [mag] Limiting mag i.e. depth of exposure.	Estimate of 5-sigma limiting mag for stellar-like objects for each science observation, derived from QCs ZPT_2MASS, SKY_NOISE, APERTURE_CORR. Can later be compared with a target value to see if main survey requirements (i.e. usually depth) are met.
QC.LINEARITY Percentage average non-linearity.	Derived from measured non-linearity curves for each detector interpolated to 10,000 counts (ADUs) level. Although all IR systems are non-linear to some degree, the shape and scale of the linearity curve for each detector should remain constant. A single measure at 10,000 counts can be used to monitor this although the full linearity curves will need to be examined quarterly [TBC] to look for more subtle changes.
QC.LINERROR_RMS percentage error in non-linearity measure	Derived from the RMS of the line fit to linearized fluxes versus exposure time and applied to a nominal level of 10,000 counts.
QC.MAGNZPT Number of stars in zero point calculation.	The number of stars on this image used to calculate the photometric zeropoint.
QC.MAGZERR [mag] Photometric zero point error.	A measure of the RMS photometric zero point error using an aperture of $1.4 \times$ [TBC] the core radius.
QC.MAGZPT [mag] Photometric zero point.	A measure of the photometric zero point using an aperture of $1 \times$ the core radius.
QC.MEAN_SKY [ADU] Mean sky level.	Computed using a clipped median for each detector sky levels (perhaps not at K_S), it should vary smoothly over the night. Strange changes in values may indicate a hardware fault (i.e. filter misplacement).
QC.NHOTPIX Number of hot pixels	The number of detected hot pixels on an image.
QC.NOISE_OBJ Number of classified noise objects per frame.	Measured using an object catalog combined with a morphological classifier. The number of objects classified as noise from frame-to-frame should be reasonably constant; excessive numbers indicate a problem.
QC.PARTICLE_RATE [count/s/detector] Cosmic ray/spurion rate.	Average number of pixels rejected during combination of dark frames, used to give an estimate of the rate of cosmic ray hits for each detector. This can later be compared with previous estimates and monitored.
QC.PERSIST_DECAY [s] Mean exponential time decay constant.	The decay rate of the persistence of bright images on subsequent exposures will be modelled using an exponential decay function with time constant decay rate. Requires an exposure on a bright star field followed a series of darks.
QC.PERSIST_ZERO Fractional persistence at T0 (extrapolated).	Determined from the persistence decay behavior from exponential model fitting. Requires an exposure on a bright star field followed a series of darks (as above).
QC.READNOISE [e-] Readnoise.	Measured from the noise properties of the difference in two consecutive dark frames, using a MAD estimator as above for robustness against spurions. The noise properties of each detector should remain stable so long as the electronics/micro-code have not been modified.
QC.RESETDIFF_MED [ADU] Median new-library reset frame.	Measure the median of the difference of a new mean reset frame and a library reset frame.

Parameter, units	Description
QC.RESETDIFF_RMS [ADU] RMS new-library reset frame	Measure the RMS of the difference of a new mean reset frame and a library reset frame.
QC.RESETMED [ADU] Median reset level	Median reset level.
QC.RESETRMS [ADU] RMS noise in combined reset frame.	Variation is defined here as the Gaussian equivalent MAD i.e. $1.48 \times$ median-of-absolute-deviation from unity after normalizing by median level i.e. measuring the RMS reset level variation. The RMS can later be compared with library values for troubleshooting problems.
QC.SATURATION [ADU] Saturation level of bright stars.	Determined from maximum peak flux of detected stars from exposures in a standard bright star field. The saturation level \times gain is a check on the full-well characteristics of each detector.
QC.SCREEN_STEP Max- imum percentage jump in monitor images	Derived from the median flux in each of the monitor exposures (if they are done). This is the maximum percentage jump between adjacent exposures in the monitored sequence.
QC.SCREEN_TOTAL To- tal percentage variation in monitor images	Derived from the median flux in each of the monitor exposures (if they are done). This is the percentage variation over the whole of the sequence of exposures.
QC.SKY_NOISE [ADU] RMS sky noise.	Computed using a MAD estimator with respect to median sky after removing large scale gradients. The sky noise should be a combination of readout-noise, photon-noise and detector quirks. Monitoring the ratio of expected noise to measured one provides a system diagnostic at the detector level.
QC.STRIPERMS [ADU] RMS stripe pattern	The RMS of the stripe pattern removed from an image.
QC.WCS_DCRVAL1 [deg] Actual WCS zero point X - raw header value.	Measure of difference between dead-reckoning pointing and true position of the detector on sky. Derived from current polynomial distortion model and 6-parameter detector model offset.
QC.WCS_DCRVAL2 [deg] Actual WCS zero point Y - raw header value.	Measure of difference between dead-reckoning pointing and true position of the detector on sky. Derived from current polynomial distortion model and 6-parameter detector model offset.
QC.WCS_DTHETA [deg] Actual difference: rotation PA - raw PA header value.	Measure of difference between dead-reckoning PA and true position angle of the detector. Derived from current polynomial distortion model and 6-parameter detector model effective rotation term.
QC.WCS_RMS [arcsec] Robust RMS of WCS solution for each detector.	Robust average of residuals from WCS solution for each detector. Measure of integrity of WCS solution.
QC.WCS_SCALE [deg/pixel] Measured WCS plate scale per detector.	Measure of the average on-sky pixel scale of a detector after correction using the current polynomial distortion model.
QC.WCS_SHEAR [deg] Power of cross-terms in WCS solution [deg].	Measure of WCS shear after normalizing by plate scale and rotation, expressed as an equivalent distortion angle. Gives a simple measure of distortion problems in WCS solution.
QC.ZPT_2MASS [mag] 1 st -pass photometric zeropoint.	The magnitude of a star that gives 1 detected ADU s^{-1} (or $\text{e}^{-} \text{s}^{-1}$) for each detector, derived using 2MASS comparison stars for every science observation. This is a first pass zero-point to monitor gross changes in throughput. Extinction will vary over a night, but detector to detector variations are an indication of a fault.
QC.ZPT_STDS [mag] 2 nd -pass photometric zeropoint.	The magnitude of a star that gives 1 detected ADU s^{-1} (or $\text{e}^{-} \text{s}^{-1}$) for each detector, derived from observations of VISTA standard star fields. Combined with the trend in long-term system zero-point properties, the ensemble "average" zero-point directly monitors extinction variations (faults/mods in the system notwithstanding) The photometric zeropoints will undoubtedly vary (slowly) over time as a result of the cleaning of optical surfaces etc.
QC.ZPT_STDS_CAT Standard catalog for photometric zeropoint.	This is a label for the standard star catalog used to calculate the photometric zeropoint.

9 References and Acknowledgments

This manual was based on many VPO documents, among which was the *VISTA IR Camera Software User and Maintenance Manual* (VIS-MAN-ATC-06080-0020), Version 2.8 from 29-April-2008, prepared by Steven Beard. The introduction and the general IR imaging sections are partly based on the Sofl and SINFONI user manuals.

The authors thank Drs. M. Rejkuba, M. Hilker, and M. Arnaboldi for their effort to review this manual, and for their valuable comments and suggestions.

A VISTA/VIRCAM Template Reference

Please note that there were a few changes in the definition of parameters⁴ and their functionality in recent observation periods with respect to the dry run which used the first generation of templates.

A.1 Historic P86 Modifications of the Templates (Oct. 2010)

VIRCAM_img_obs_tile6sky: Introduced a new template that allows to obtain images of a sky field interleaved with the pawprints.

Jitter_2ua, Jitter_2da: New asymmetric jitter patterns introduced to avoid the execution of the first offset in a jitter pattern (the first offset is set to 0,0).

A.2 Historic P85 Modifications of the Templates (Feb. 2010)

Randomized Jitter at the First Exposures: The first exposure will as well be taken at a randomized position in the jitter box. (In the past version the 1st exposure was taken at x,y-position 0.0,0.0)

Flags for SKY Fields and EXTENDED objects: There are three options for parameter **OCS.EXTENDED**: DEFAULT, EXTENDED and SKY which are used to flag the data as normal *pawprint*, *jitter* sequences (DEFAULT), or as extended object (EXTENDED), or as sky fields (SKY). The parameter doesn't change the sequence of observations on the sky, but will allow to properly flag the obtained data sets for the later data reduction. Users should use these flags to prepare their OBJECT,SKY sequences within concatenations.

Modified Labels and More Hidden Parameters: The parameter labels were changed to be more clear in some cases (like in case of the TEL.ROT.OFFANGLE for which we have included a mini-help to make clear that this is the opposite of the position angle). Some parameters which are not supposed to be changed were hidden in this release

A.3 Introduction to the Phase 2 Preparation for Public Surveys

All scientific and calibration observations with ESO instruments are prepared as observing blocks (OBs) with the Phase 2 Proposal Preparation (P2PP) tool. The scheduling of these OBs is then done on-site with the broker of observing blocks (BOB) tool, and the P2PP in visitor mode or with the Observation Tool (OT) during the Service Mode (SM) observations. The P2PP has been heavily modified with respect to the previous versions to handle the survey operations.

Observing blocks contain the target information, a small number of user selected templates, constraints sets and the scheduling (timing) information. The parameters of the templates define the configuration and set up to be used for the respective observations. Some parameters are selectable by users, others are "hidden" from the users to simplify the templates. The hidden parameters cannot be changed by the users but only by the telescope and instrument operators. The templates are reviewed, usually at change of observing periods, and the list of their parameters might undergo modifications. Therefore, the users should use the latest version of this Manual for the preparation of their observations.

⁴Sometimes the template parameters are referred to as template keywords.

For the ESO survey telescopes (VISTA and VST) a survey area definition tool (SADT) was developed to allow the preparation of large number of similar or identical OBs, necessary for covering large survey areas with “tiles” (a mosaic of six “pawprints” offset that covers twice, nearly uniformly the otherwise sparsely populated VIRCAM field of view; see Sec. 7.4). The SADT also selects auto guider and wave front sensor stars from astronomical catalogs. The result of the survey area definition is written at the end into an xml-format file, to be imported later into P2PP. The user is required to prepare only one initial OB (or a few, if the survey is not entirely uniform), and the P2PP tool will clone OBs with the same parameter sets for every tile of the survey. The SADT is described in detail in a separate user manual and in the SADT Cookbook. See also:

<http://www.eso.org/sci/observing/phase2/SMGuidelines/SADT.html>

Both P2PP and OT were heavily modified with respect to the previous versions to handle the large number of public survey OBs. The most prominent modification is the new functionality to group the OBs in scheduling containers (Sec. 7.5). Three types of scheduling containers have been defined: Concatenations, Time Links and Groups. They are described in more details in the User’s Manual of P2PP for Surveys.

Table 14: VIRCAM@VISTA templates.

Template Name	Functionality
to be used together with SADT:	
VIRCAM_img_acq_tile	preset, instrument set up and acquisition of guide stars
VIRCAM_img_obs_tile1	take a jitter and microstep sequence on one pawprint
VIRCAM_img_obs_tile3	take a jitter and microstep sequence on three vertical pawprint
VIRCAM_img_obs_tile6	take a jitter and microstep sequence on a full set of 6 pawprints
VIRCAM_img_obs_tile6sky	like VIRCAM_img_obs_tile6 but take sky images interleaved with the pawprints
to be used without SADT support:	
VIRCAM_img_acq_quick	preset, to be used only with cal_std and cal_illumination templates
VIRCAM_img_obs_paw	take a jitter and microstep sequence on one pawprint without selecting guide stars
VIRCAM_img_cal_illumination	take an illumination correction
VIRCAM_img_cal_std	take a standard star observation
VIRCAM_img_obs_offsets	make a sequence of exposures at a user-defined set of telescope offsets, for technical tests (it does not offer AO and AG).

The design of VIRCAM@VISTA requires only a small number of observation templates (Table 14). Most surveys will use only two templates: VIRCAM_img_acq_tile and VIRCAM_img_obs_tile6. In addition, two calibration templates VIRCAM_img_cal_std and VIRCAM_img_cal_illumination are available. They are used with VIRCAM_img_acq_quick acquisition template, and do not require input files from the SADT. Similarly there is an option to take science exposures without the use of SADT with the templates VIRCAM_img_acq_quick and VIRCAM_img_obs_paw, which are identical in their functionality, but provide a different list of user selected parameters. The calibration observations like twilight flats, darks, and standard star observations, as well as the maintenance templates are not prepared by the users. They are not described in this user manual.

The observing strategy and the optimization of VISTA observations are discussed in Sec. 7.6. Next, we will describe the VIRCAM@VISTA templates.

A.4 The Acquisition Templates – VIRCAM_img_acq_tile and VIRCAM_img_acq_quick

The acquisition templates will set up telescope, the instrument, and it will preset the telescope to the requested sky position. If needed then the auto guiding and wave front sensing will be started at this position. VIRCAM_img_acq_tile is used in combination with VIRCAM_img_obs_tile<N> “survey” templates (Sec. A.5.1), and VIRCAM_img_acq_quick is used only with single pawprint snapshot template VIRCAM_img_obs_paw, and with the standard star templates VIRCAM_img_cal_std and VIRCAM_img_cal_illumination seen within P2PP in the calibration template section.

The acquisition templates set the instrument into IMAGING mode and select the science filter. It also points the telescope to a new target (using a “preset”). The pointing center is the rotator center unless specified otherwise in the optional (X,Y) parameters. The default field of view orientation points the Y axis to the North and X axis to the West. The position angle (**Camera sky position angle**) is defined at the pointing center (note that the large field of view leads to some small deviations in the orientation away from the center). If autoguiding and active optics correction are required to be set by the acquisition template (**Enable autoguiding='T'** and **Enable active optics='T'**) one guide star and two AO stars are read from on-line catalogs (see below). Most parameters are self-explanatory. A brief description of some of them is given below:

Rotator Angle on Sky: Orientation on the sky, **opposite sign convention than the position angle on the sky**. This parameter is filled in automatically when the XLM file created by SADT is imported into P2PP and it **SHOULD NOT** be changed after this has been done because any change will lead to observing a wrong patch of the sky. The rotator angle is however to be set by the user for single pawprint observations or standard star fields.

Differential tracking in RA and **Differential tracking in DEC** : both these parameters **MUST** be set to “0.0”, because the differential tracking has not been enabled or tested yet.

X Coord of Pointing and **Y Coord of Pointing**: set an initial offset on the focal plane (in mm); This is set (hard coded) to zeros (corresponding to the center) for normal survey observations (in the acq_tile template), but must be set correctly to non-zero values for pawprint observations if it is required to center targets on the respective detectors. The offsets that would center a target on individual detectors are listed in Table 15.

Active optics priority : Optional for the users to specify if the low order active optics corrections have “HIGH”, “NORMAL” or “LOW” priority with respect to the science observations. This parameter should be set to “HIGH”, if the requested seeing is about 1.0 arcsec or better. For now there is a more complex logic in place considering that the AO can be run in parallel to the science observations. The AO-priority defines an altitude and time difference within which a AO-correction is considered as valid. Only in the case of “HIGH” priority it will wait for a first valid correction. For short exposures, when the AO can not be done in parallel, the template will however wait for one loop AO if there is no valid AO-correction done. Please note that the definition of the AO-priority will be reviewed after the experience of science verification and dry runs.

Confirm guide star? and **Confirm active optics?** select if the operator will be asked to confirm starting the autoguiding and low order wave front sensing, based on his evaluation of the AG and AO performance. It is recommended to leave this parameter to “F”. It is not selectable for the SADT based tile observations, for which the guide stars are defined in each of the tiles independently.

“Enable autoguiding” and “Enable active optics”: Select if the autoguiding and low order wave front sensing shall be started or not. This should be kept as “F” for public surveys prepared with SADT where the guide and WFS stars are provided for all pawprints in the “tile”-templates. It should be left in “T” in the case that the OB is prepared without using the SADT (with template VIRCAM_img_acq_quick).

Filter name: selects the filter to be used during the acquisition. It is recommended to use the same filter as in the first science observing template to minimize the filter wheel movement. Using many filters in one OB is only allowed for the science observation (but it is discouraged for operational reasons). Multiple filters can even be included in one template via the nesting (Sec.7.6). However, it is strongly recommended to separate the filters into individual templates (in the same OB) to minimize the time loss in case of OB abort and restart. For now it is not allowed to select twice the same filter in the same template.

Template Sequence: The steps through the execution of the template can be summarized like below. To save time, the instrument will be set up in parallel to the telescope preset. With the default parameter setting there will be no step which requires manual interaction.

Acquisition Template Execution Sequence:

```

-----
If pointing origin is not (0,0) then
  Adjust telescope coordinates to bring target to pointing origin.
End if
Set instrument mode to IMAGING.
  If science filter has been specified
    Select science filter.
  End if
Preset telescope to target (if XY offset != 0,0)
If science filter has been specified
  Adjust telescope focus for science filter.
End if
If autoguiding is enabled then
  If AG.CONFIRM is TRUE then
    Prompt operator to confirm autoguiding.
  End if
  Wait for autoguiding to start
End if
If the AO correction is invalid
  If active optics are enabled and AO.PRIORITY == ‘HIGH’ then
    Wait for active optics to start
  End if
End if

```

VIRCAM_img_acq_quick is functionally identical to VIRCAM_img_acq_tile, but with a different selection of user defined input parameters. The only specifics for this template is related to the parameters **X Coord of Pointing** and **Y coord of pointing** that define the initial offsets on the focal plane (in mm). In most cases the (initial) offset parameters must be modified, because the center of the focal plane is in the gap between detectors 6, 7, 10, and 11. Therefore, the target will not be covered by any of the detectors. A map of the focal plane with the offsets that would put the target at the center

Table 15: Offset map placing a target at the center of a given detector array for the VIR-CAM_img_acq_quick template. The corresponding offsets on the sky in arcsec are listed in brackets.

Y coord of pointing	X Coord of Pointing			
	87.9 mm (−1484 arcsec)	29.3 mm (−494 arcsec)	−29.3 mm (494 arcsec)	−87.9 mm (1484 arcsec)
117 mm (−1978 arcsec)	13	14	15	16
39 mm (−659 arcsec)	9	10	11	12
−39 mm (659 arcsec)	5	6	7	8
−117 mm (1978 arcsec)	1	2	3	4

of a given detector is given in Table 15. The corresponding offsets on the sky in arcsec are listed in brackets.

A.5 The Science Observation Templates

A.5.1 VIRCAM_img_obs_tile<N>

The tile-templates will take jitter sequences over the full field of view of the camera, using a selection of pawprints, jitter and microstep telescope offset, implemented with the different nesting strategies as described in Sec.7.6. The templates will set up the telescope, the instrument, and the detector controller according to the user selected parameters. There are three template versions depending on the number of pawprints in the tile pattern: VIRCAM_img_obs_tile1, VIRCAM_img_obs_tile3, and VIRCAM_img_obs_tile6. The template parameters are listed in Table21. The sizes of geodesic rectangles (representing the field of view) covered by these templates are listed in Table 16. Only the tile6-template would guarantee the full coverage of the field of view of the telescope. In case of the tile3 templates the full field coverage would be only guaranteed in case that observations with two tile3-templates are taken with the alternating tile-patterns (the latter is still to be implemented with SADT – to be confirmed later).

The tile pattern is selected early in the observing strategy selection process - in the SADT. This is necessary because the SADT must search and select AO and AG reference stars, and to do that it needs to know the tile pattern. **NOTA BENE** : If the tile pattern is changed after importing the SADT produced xml file, then wrong AO/AG reference stars will be passed over to the TCS leading to the failure of the execution.

Table 16: Sizes of geodesic rectangles (representing the field of view) covered by different science templates at least once and twice. The maps of the coverage is shown in Fig. 19 and the details of “filling-in” a tile are described in Sec. 7.4.2.

Science template	Coverage at least once		Coverage at least twice	
	Width X, deg	Height Y, deg	Width X, deg	Height Y, deg
VIRCAM_img_obs_tile1 (pawprint)	1.292117	1.017301	-	-
VIRCAM_img_obs_tile3 (half-tile)	1.292117	1.201	1.292117	1.017301
VIRCAM_img_obs_tile6 (tile)	1.475	1.201	1.475	1.017301
VIRCAM_img_obs_tile6sky	1.475	1.201	1.475	1.017301

The users **MUST NOT CHANGE** the **Name of tile pattern** after importing the SADT xml file. Similarly the **jitter box size** or the **jitter scale multiplier** can be only modified by small factors, without risking that the guide and wave front sensor stars will fall off the respective detectors. (Please note: Copying the observation descriptions in P2PP from OB to OB may cause inconsistent OBs for the same reasons).

Each time a new pawprint is selected, the telescope control system (TCS) is provided with a new set of guide and wave front sensor stars, read from the PAF files which are provided with the template after importing the Survey Area Definition File. The pawprint, jitter and microstep patterns are executed in the detector coordinate system, using the camera position angle specified in the acquisition template VIRCAM_img_acq_tile.

Multiple filters are not allowed in a single template but if this is justified, the user can obtain a waiver from the USD. If the science template observes in multiple filters specified in a list, it may be necessary to use different DITs and NDITs for each of them (because the filters have different transmissions, and the targets may have different colors). It is possible to do this by specifying the **(List of) integration time(s)** (DET1.DIT) and the **(List of) number of integrations** (DET1.NDIT) parameters as lists. The lists must have exactly the same length as the list of science filters but if DET1.DIT and DET1.NDIT are given as single values, these exposure parameters will be applied to all filters. For example:

(List of) integration time(s)	DET1.DIT	"1.0"
(List of) number of integrations	DET1.NDIT	"12"
List of science filters	INS.FILTER.NAME	"H J K _S "

will obtain exposures in H, J and K_S filters, built as 12 co-adds (not averages!) of 1.0 sec, and

(List of) integration time(s)	DET1.DIT	"2.0 3.0 1.0"
(List of) number of integrations	DET1.NDIT	"6 4 12"
List of science filters	INS.FILTER.NAME	"H J K _S "

the exposures in H, J and K_S filters will be built as 6 co-adds of 2.0 sec, 4 co-adds of 3.0 sec, 12 co-adds of 1.0 sec, respectively.

Several identical observation templates can be attached after the acquisition template (VIRCAM_img_acq_tile). Each template can have a different filter, and the corresponding choice of DIT and/or NDIT facilitating the requirement mentioned above to have only one filter per template.

A brief description of some template parameters:

Is object extended? (OCS.EXTENDED) This parameter is used to identify fields with extended objects which requires special data reduction recipes for the sky subtraction. Similarly the respective potential sky fields can be flagged to be later concatenated with the observation block which contains the extended object.

Jitter scale multiplier (SEQ.JITTER.SCALE), **Scale factor** (SEQ.TILE.SCALE), and **Microstep scale multiplier** (SEQ.USTEP.SCALE) : define the scale factors to increase the dimensionless offset (see below) read from the set up files. SEQ.TILE.SCALE must be left to the default to guaranty that the guide and wave front sensor stars do not fall off the respective detectors.

Name of tile pattern (SEQ.TILE.ID) : selects offset patterns for the tile. Unlike for other ESO instruments, the **VISTA offsets are absolute with respect to the initial position at the start of**

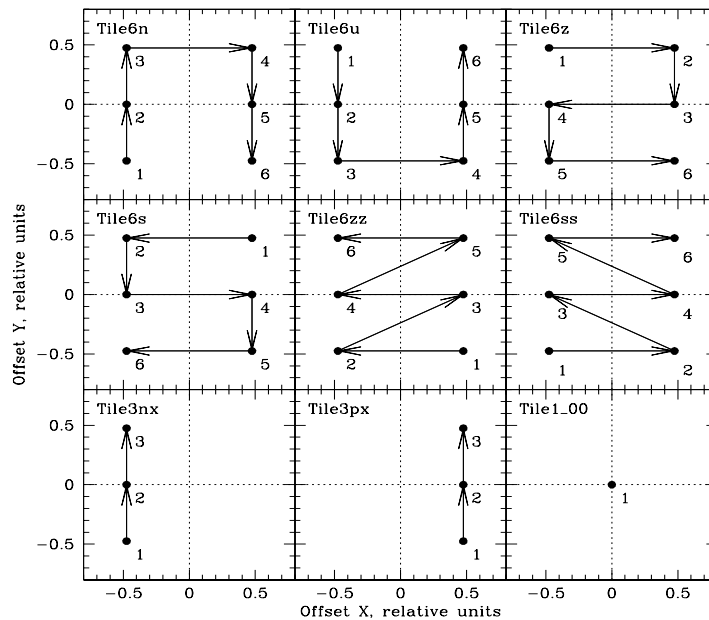

Figure 25: Fixed tile patterns. The negative X corresponds to west and positive X to east; Y runs from south (negative) to north (positive) for the default tiling orientation in the SADT. The numbers indicate the sequence of pointings and the arrows show the direction of the offsets.

the observing sequence. The user has to select one of the predefined tile patterns listed in Table 17 and shown in Fig. 25. The **Name of tile pattern** is set when the Survey Definition xml-file is imported and **MUST NOT** be changed after that. It can be left at the default value for VIRCAM_img_obs_tile1 and VIRCAM_img_obs_tile6 templates. One of the functionalities that this parameter allows is to split a tile into two OBs, for example if it is necessary to reduce the OB execution time below the service mode limit of 1 hr (exceptionally, a waiver allowing OB execution time of up to 1.5 hr may be granted by the USD). In this case, instead of one OB with one VIRCAM_img_obs_tile6 template, the user should create two OBs, each with one VIRCAM_img_obs_tile3 template, but with different tile patterns - one with the Tile3nx, and the other with Tile3px (still to be confirmed if the SADT can guaranty the full field coverage with the two tile3 patterns as mentioned above).

Name of jitter pattern (SEQ.JITTER.ID) : selects offset patterns for the jitter sequence. **These offsets are also absolute with respect to the initial position at the start of the sequence.** The user has to select one of the predefined jitter patterns listed in Table 18 and shown in Fig. 26. A single pointing and a random jitter pattern are also available (the parameter value must be set to "SINGLE" and "RANDOM", respectively). The latter enables the "jitter box size" and the "number of jitter offset" parameters, which are ignored for the fixed jitter patterns.

Random Jitter: "Maximum size of jitter", "Number of Jitters" The respective parameters for the jitter box radius and the number of jitter exposures are only used for the random jitter. The jitter sequence will start already the first exposure at a randomized position.

Name of microstep pattern (SEQ.USTEP.ID) parameter can be set to: "Single" (default, 1 exposure) or "Ustep2x2" (4 exposures taken with half pixel offsets in a squared pattern). In summary, the sequence would take for every filter of the list, at every of typically 6 pawprints of a tile, at every jitter

Table 17: Fixed tile patterns.

$N_{paw}=6$ patterns :	
Tile6n	
SEQ.TILE.NAME	6 step n pattern
SEQ.TILE.OFFSETX	-0.475 -0.475 -0.475 0.475 0.475 0.475
SEQ.TILE.OFFSETY	-0.475 0.0 0.475 0.475 0.0 -0.475
Tile6u (default for VIRCAM_img_obs_tile6)	
SEQ.TILE.NAME	6 step u pattern
SEQ.TILE.OFFSETX	-0.475 -0.475 -0.475 0.475 0.475 0.475
SEQ.TILE.OFFSETY	0.475 0.0 -0.475 -0.475 0.0 0.475
Tile6z	
SEQ.TILE.NAME	6 step large Z pattern
SEQ.TILE.OFFSETX	-0.475 0.475 0.475 -0.475 -0.475 -0.475
SEQ.TILE.OFFSETY	0.475 0.475 0.0 0.0 -0.475 -0.475
Tile6s	
SEQ.TILE.NAME	6 step large S pattern
SEQ.TILE.OFFSETX	0.475 -0.475 -0.475 0.475 0.475 -0.475
SEQ.TILE.OFFSETY	0.475 0.475 0.0 0.0 -0.475 -0.475
Tile6zz	
SEQ.TILE.NAME	6 step zz zig zag pattern
SEQ.TILE.OFFSETX	0.475 -0.475 0.475 -0.475 0.475 -0.475
SEQ.TILE.OFFSETY	0.475 -0.475 0.0 0.0 0.475 0.475
Tile6ss	
SEQ.TILE.NAME	6 step ss zig zag pattern
SEQ.TILE.OFFSETX	-0.475 0.475 -0.475 0.475 -0.475 0.475
SEQ.TILE.OFFSETY	-0.475 -0.475 0.0 0.0 0.475 0.475
$N_{paw}=3$ patterns :	
Tile3nx	
SEQ.TILE.NAME	3 step nx (negative x) pattern
SEQ.TILE.OFFSETX	-0.475 -0.475 -0.475
SEQ.TILE.OFFSETY	-0.475 0.0 0.475
Tile3px	
SEQ.TILE.NAME	3 step px (positive x) pattern
SEQ.TILE.OFFSETX	0.475 0.475 0.475
SEQ.TILE.OFFSETY	-0.475 0.0 0.475
$N_{paw}=1$ pattern :	
Tile1_00	
SEQ.TILE.NAME	1 pawprint pattern
SEQ.TILE.OFFSETX	0.0
SEQ.TILE.OFFSETY	0.0

Table 18: Fixed jitter patterns.

VIRCAM_Jitter2d	2 position pattern - diagonal left to right down
SEQ.JITTER.OFFSETX	-10.0 10.0
SEQ.JITTER.OFFSETY	10.0 -10.0
VIRCAM_Jitter2da	2 position pattern - center to right up
SEQ.JITTER.OFFSETX	0.0 20.0
SEQ.JITTER.OFFSETY	0.0 20.0
VIRCAM_Jitter2u	2 position pattern - diagonal left to right up
SEQ.JITTER.OFFSETX	-10.0 10.0
SEQ.JITTER.OFFSETY	-10.0 10.0
VIRCAM_Jitter2ua	2 position pattern - center to right down
SEQ.JITTER.OFFSETX	0.0 20.0
SEQ.JITTER.OFFSETY	0.0 -20.0
VIRCAM_Jitter3d	3 position pattern - diagonal left to right down
SEQ.JITTER.OFFSETX	0.0 -10.0 10.0
SEQ.JITTER.OFFSETY	0.0 10.0 -10.0
VIRCAM_Jitter3u	3 position pattern - diagonal left to right up
SEQ.JITTER.OFFSETX	0.0 -10.0 10.0
SEQ.JITTER.OFFSETY	0.0 -10.0 10.0
VIRCAM_Jitter4u	4 position pattern U shape rotated 30deg ccw
SEQ.JITTER.OFFSETX	-3.66 13.66 3.66 -13.66
SEQ.JITTER.OFFSETY	13.66 3.66 -13.66 -3.66
VIRCAM_Jitter5n	5 position pattern n shape with cent re rotated 60deg cw
SEQ.JITTER.OFFSETX	0.0 -8.66 5.0 8.66 -5.0
SEQ.JITTER.OFFSETY	0.0 5.0 8.66 -5.0 -8.66
VIRCAM_Jitter5z	5 position pattern Z rotated 30deg ccw
SEQ.JITTER.OFFSETX	0.0 -3.66 13.66 -13.66 3.66
SEQ.JITTER.OFFSETY	0.0 13.66 3.66 -3.66 -13.66
VIRCAM_Jitter9s	9 position pattern square shape rotated 30 deg ccw
SEQ.JITTER.OFFSETX	0.0 -13.66 -8.66 -3.66 5.0 13.66 8.66 3.66 -5.0
SEQ.JITTER.OFFSETY	0.0 -3.66 5.0 13.66 8.66 3.66 -5.0 -13.66 8.66
VIRCAM_Jitter25s	25 position pattern square spiral rotated 30 deg ccw
SEQ.JITTER.OFFSETX	0.0 -4.33 -1.83 2.5 6.83 4.33 1.83 -2.5 -6.83 -11.16 -8.66 -6.16 -3.66 0.67 5.0 9.33 13.66 11.16 8.66 6.16 3.66 -0.67 -5.0 -9.33 -13.66
SEQ.JITTER.OFFSETY	0.0 2.5 6.83 4.33 1.83 -2.5 6.83 4.33 1.83 0.67 5.0 9.33 13.66 11.16 8.66 6.16 3.66 -0.67 -5.0 9.33 13.66 11.16 8.66 6.16 3.66
VIRCAM_Jitter30r1	30 position pattern (random numbers)
SEQ.JITTER.OFFSETX	5.66 -9.10 9.37 -2.73 -4.77 6.63 -9.56 7.53 3.14 -5.63 -8.22 4.91 2.24 3.61 6.70 -2.66 5.65 6.16 -3.59 -0.88 -2.24 1.16 -3.11 -7.61 -9.96 7.85 4.86 -5.02 -6.66 2.49
SEQ.JITTER.OFFSETY	9.89 -4.65 4.11 3.19 -4.87 -6.68 4.35 -5.17 1.83 -0.94 -4.27 -8.02 7.95 -8.11 4.76 5.40 -8.78 -2.31 8.16 -7.51 -8.55 -9.94 -5.19 2.57 8.39 5.64 -9.29 -4.03 -0.84 4.00

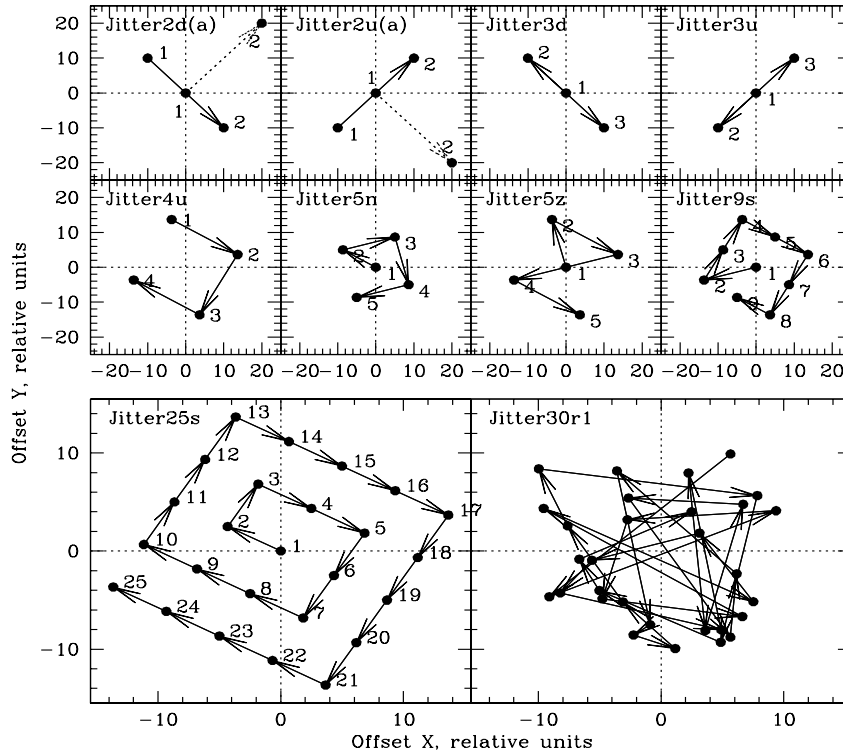

Figure 26: Fixed jitter patterns. The orientation is the same as in Fig. 25. The numbers indicate the sequence of pointings and the arrows show the direction of the offsets. The dashed arrows on the two left panels in the top row show the (a)-designated patterns (see Table 18). For clarity the maps of Jitter25s and Jitter30r1 are blown up, and the numbering is omitted in the lower right side panel.

position either 1 or 4 exposures offset by half pixel size microsteps. The default value is "Single", and it doesn't use microstepping. It is strongly recommended to keep this parameter with default "Single" value and not to use microstep. From preliminary results from commissioning we expect a complicated PSF shape as the result of microstepping. **Therefore the PIs should discuss the microstep strategy with ESO and CASU.**

The science observation sequence can be summarized in the following program listing, in case of the default "nesting":

Science Template Execution Sequence:

```

-----
If SEQ.NESTING is FPJME then
  For each science filter
    Select science filter
    Determine telescope focus for science filter.
    For each pawprint
      If SEQ.REF.FILE(pawprint) is not a blank or null string then
        If SEQ.REF.FILE(pawprint) file exists then
          Define new guide star setup parameters from
            SEQ.REF.FILE(pawprint).
        Else
          Issue warning and define new guide star setup
            parameters to select stars on the fly from
              online cataloger.
        Endif
      Else
        (Keep previously defined stars).
      Endif
    For each jitter offset
      For each microstep offset.
        Convert (X,Y,ROT) offset into (ALPA,DELTA,ROT) offset
        Offset telescope to pawprint, jitter and microstep offset
        If new guide stars are available then
          If TEL.AG.START is TRUE then
            If AG.CONFIRM is TRUE then
              Prompt operator to confirm autoguiding.
            End if
            Wait for autoguiding to start
          End if
          If TEL.AO.START is TRUE and AO.PRIORITY > 0 then
            Wait for active optics to start
          End if
        Endif
      Get WCS information from TCS.
      Calculate dwell time (NEXPO * DIT * NDIT) and inform TCS.
    For each exposure
      Define header parameters:
        TILE_ID, TILE_I, TILENUM
        NJITTER, JITTRNUM, JITTR_ID, JITTER_I, JITTER_X, JITTER_Y,
        NUSTEP, USTEPNUM, USTEP_ID, USTEP_I, USTEP_X, USTEP_Y
      Set WCS parameters.

```

```

        Make exposure
        Next exposure
        Next microstep
        Next jitter
        Next pawprint
        Next science filter
Else if SEQ.NESTING is PFJME then
    ...
    ...
Else if SEQ.NESTING is FJPME then
    ...
    ...
End if

```

Number of exposures taken with a science observation template : For N filters in the list, 6 pawprints taken within the tile6 template, 5 jitter positions of the jitter5x pattern, and 2 microstep exposures, one would obtain $N \times 6 \times 5 \times 2 = N \times 60$ exposures (written on the disk in 60 different fits files). Each exposure is the sum – not the average, as is the case with most other ESO IR instruments – of NDIT individual detector integrations of DIT seconds.

A.5.2 VIRCAM_img_obs_tile6sky

This template is used to observe extremely crowded fields and/or extended objects that cover large fraction of the VISTA field of view, making self-sky-subtraction impossible. It obtains a number (SEQ.SKYJITTER.NJITTER) of randomly jittered images within a box with a given size (SEQ.SKYJITTER.MAX), centered at a user defined sky position (SEQ.SKYOFFSET.ALPHA, SEQ.SKYOFFSET.DELTA).

The sky fields are only executed if the option “FIXEDSKYOFFSET” is selected in the “is object extended” field in P2PP. This was introduced to simplify the survey preparation in case that the sky field is only required for a few tiles on a larger survey area. In case that other options (DEFAULT, EXTENDED or SKY; they were meant to provide instructions to the pipeline what recipe to use for the data reduction, a feature that is not implemented) are selected, the template sequence would follow exactly the one of the VIRCAM_img_obs_tile6 template.

The template operate as follows: first it takes images at the six pawprints that form the tile, at the first jitter positions in each pawprint (the jitter pattern is identical for all pawprints). Next, it goes to the offset sky field, and takes images jittering there, within a user defined jitter box, following a user-defined jitter pattern. Then, the template returns to the second jitter position of the first pawprint of the tile, end begins to circle through all pawprints in the tile. After the tile is completed, the next sequence of jandom-jittered sky images is taken, and so on. The template ends with a sky sequence. An example is shown in Fig. 27, for the following parameters:

SEQ.TILE.ID=“Tile6z”	INS.FILTER.NAME=“J”
SEQ.TILE.SCALE=“1.0”	OCS.EXTENDED=“FIXEDSKYOFFSET”
SEQ.TILE.FROMPAW=“1”	SEQ.SKYJITTER.MAX=“210.0”
SEQ.JITTER.ID=“Jitter5z”	SEQ.SKYJITTER.NJITTER=“5”
SEQ.JITTER.MAX=“15.0”	SEQ.SKYOFFSET.ALPHA=“160853.000”
SEQ.JITTER.NJITTER=“1”	SEQ.SKYOFFSET.DELTA=“-022847.000”
SEQ.USTEP.ID=“Single”	SEQ.SKYOFFSET.ROT=“0.0”

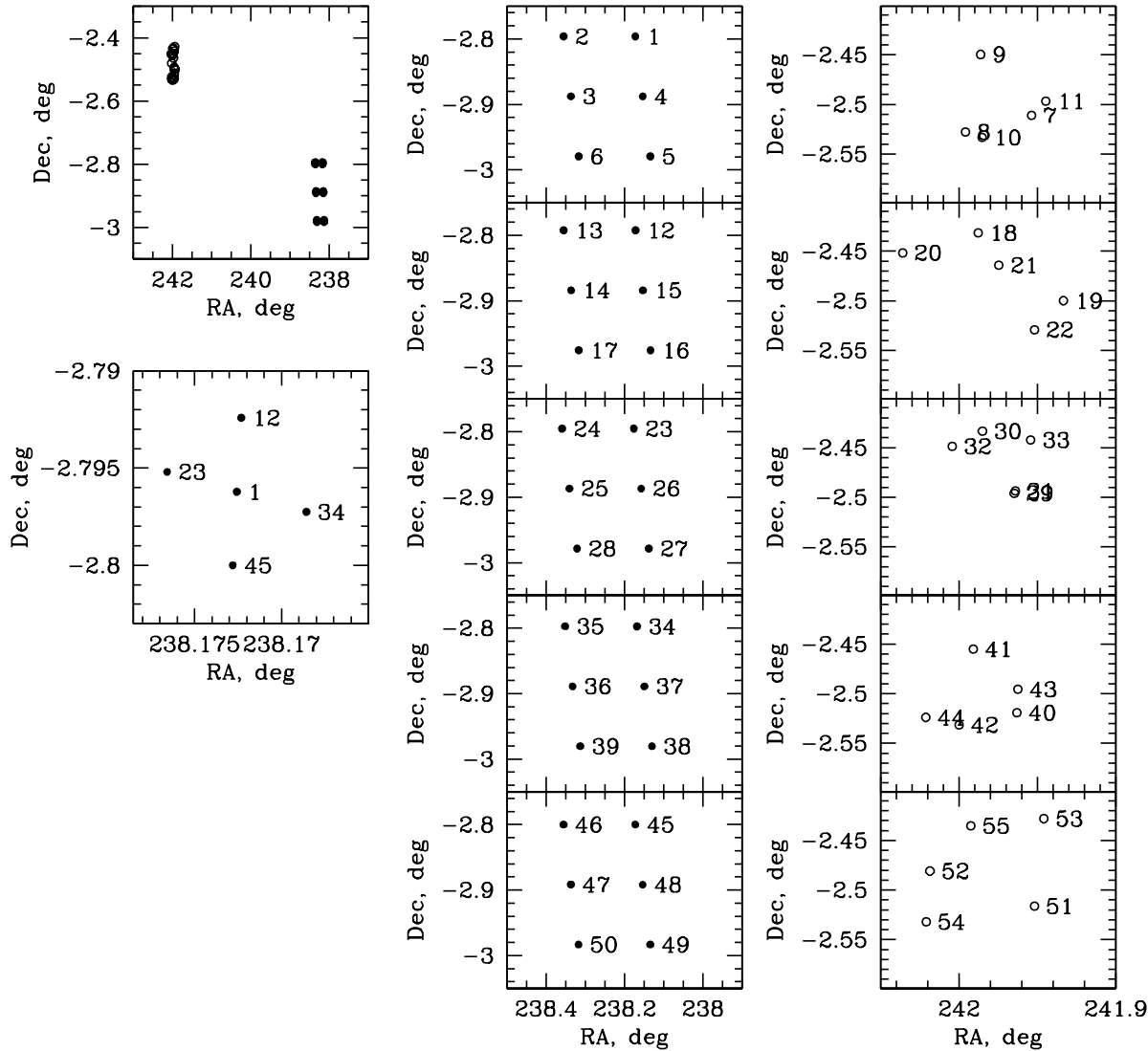

Figure 27: Example of an offset pattern for the VIRCAM_img_obs_tile6sky template. The numbers indicated the sequence in which the images are taken. Solid dots mark images in the tile, open circles are images in the sky field. Panels: *left column, top*: the entire pattern, the sky field is in the top left corner, the tile proper – in the bottom right; *left column, middle*: blow-up of the jitter pattern for the first pawprint only; *middle column*: five sequential (from top to bottom) jittered pawprints; *right column*: five sequential (from top to bottom) randomly jittered sky sequences. The template parameters in this example are listed in Sec. A.5.2. Note that the number of jitters at each pawprint and the number of sky jitters can be different, but they should be equal in order to have the same S/N on the sky and on the object – if the number of jitters on the sky is smaller, the sky subtraction will introduce extra noise into the data because the noise of the sky will dominate the overall noise budget. The number of sky jitters can be reduced only if the time between the sky sequences is small (1–3 min), and one can combine all sky images from them together, to create a common sky that will be used to remove the sky contribution for the individual pawprints.

A.5.3 VIRCAM_img_obs_paw

The “paw-print”-template takes a jitter sequence around **only one of the six payprints that would comprise a tile**. The definition of the parameters and the template sequence are both identical to the VIRCAM_img_obs_tile templates. See for details Sec. 7.4 and Figures 17, 18, and 19.

A.6 The Calibration Templates – VIRCAM_img_cal_illumination and VIRCAM_img_cal_std

The illumination correction template VIRCAM_img_cal_illumination obtains a sequence of images with different XY-offsets which allows the user to estimate the sky concentration and the illumination corrections based on the photometry of the same sources (either a single photometric standard is used, or a large number of field stars, to avoid variability issues). However, the illumination correction can also be estimated from the spatial trends of photometric zero-points derived from the 2MASS stars in each science field.

The standard star template VIRCAM_img_cal_std is used to obtain a sequence of a standard star or standard star field for an additional photometric consistency check, independent from the zero-points measured in the science fields.

The parameters of these two templates are listed in Tables 22 and 23.

A.7 Template Parameter Tables

Tables 19, 20, 21, 22, and 23 list the parameters of the available VIRCAM@VISTA templates (except for tile6sky which is nearly identical).

Table 19: VIRCAM@VISTA acquisition template VIRCAM_img_acq_tile parameters. Parameter which are typically updated by users are highlighted.

P2PP Label	FITS header Parameter	Type	Range	Default	Description
imported via xml file from SADT and translated to the target section of P2PP:					
RA	TEL.TARG.ALPHA	coord	000000..240000	–	Alpha for the target in HHMMSS.TTT
DE	TEL.TARG.DELTA	coord	–900000..900000	–	Delta for the target in DDMMSS.TTT
Equinox	TEL.TARG.EQUINOX	parameter		J2000	Equinox expressed as year
Proper motion in RA	TEL.TARG.PMA	number	–500..500	0.0	Proper Motion Alpha in arcseconds/year
Proper motion in DEC	TEL.TARG.PMD	number	–500..500	0.0	Proper Motion Delta in arcseconds/year
Epoch	TEL.TARG.EPOCH	parameter		2000	Epoch expressed as year. Only 1950 or 2000 are valid values
user selected in the acquisition templates:					
Rotator Angle on Sky from SADT	TEL.ROT.OFFANGLE	number	–180.0..180.0	0.0	Camera sky position angle as \pm DDD.TTT
Active optics priority	TEL.AO.PRIORITY	parameter	LOW HIGH	NORMAL NORMAL	LOW=never wait, NORMAL=sometimes wait, HIGH=always wait.
Differential tracking in RA	TEL.TARG.ADDVELALPHA	number	–15..15	0.0	Alpha additional tracking velocity in arcseconds/s
Differential tracking in DEC	TEL.TARG.ADDVELDELTA	number	–15..15	0.0	Delta additional tracking velocity in arcseconds/s
Epoch system (default J=Julian)	TEL.TARG.EPOCHSYSTEM	parameter	J B	J	Epoch system expressed as a
Filter name	INS.FILTER.NAME	parameter	ISF FILTERS		Name of the filter element to place in the beam (checks switches).

Table 20: VIRCAM@VISTA acquisition template VIRCAM_img_acq_quick parameters. Parameter which are typically updated by users are highlighted.

P2PP Label	FITS header Parameter	Type	Range	Default	Description
translated to the target section of P2PP:					
RA	TEL.TARG.ALPHA	coord	000000..240000	–	Alpha for the target in HHMMSS.TTT
DEC	TEL.TARG.DELTA	coord	–900000..900000	–	Delta for the target in DDMSS.TTT
Equinox	TEL.TARG.EQUINOX	parameter		J2000	Equinox expressed as year
Proper motion in RA	TEL.TARG.PMA	number	–500..500	0.0	Proper Motion Alpha in arcseconds/year
Proper motion in DEC	TEL.TARG.PMD	number	–500..500	0.0	Proper Motion Delta in arcseconds/year
Epoch	TEL.TARG.EPOCH	parameter		2000	Epoch expressed as year. Only 1950 or 2000 are valid values
user selected in the acquisition templates:					
Confirm guide star?	TEL.AG.CONFIRM	boolean	T F	F	If T, then request operator confirmation, otherwise not.
Enable autoguiding	TEL.AG.START	boolean	T F	T	If T, then autoguiding is enabled, otherwise not.
Confirm active optics?	TEL.AO.CONFIRM	boolean	T F	F	If T, then request operator confirmation, otherwise not.
Active optics priority	TEL.AO.PRIORITY	parameter	LOW NORMAL NORMAL HIGH		LOW=never wait, NORMAL=sometimes wait, HIGH=always wait.
Enable active optics	TEL.AO.START	boolean	T F	T	If T, then active optics is enabled, otherwise not.
Rotator Angle on Sky (deg)	TEL.ROT.OFFANGLE	number	–180.0..180.0	0.0	Camera sky position angle as \pm DDD.TTT
Differential tracking in RA	TEL.TARG.ADDVELALPHA	number	–15..15	0.0	Alpha additional tracking velocity in arcseconds/s
Differential tracking in DEC	TEL.TARG.ADDVELDELTA	number	–15..15	0.0	Delta additional tracking velocity in arcseconds/s
Epoch system (default J=Julian)	TEL.TARG.EPOCHSYSTEM	parameter	J B	J	Epoch system expressed as a
X coord of pointing	TEL.TARG.X	number	–500.0..500.0	0.0	Pointing origin X in focal plane (mm).
Y coord of pointing	TEL.TARG.Y	number	–500.0..500.0	0.0	Pointing origin Y in focal plane (mm).
Filter name	INS.FILTER.NAME	parameter	ISF FILTERS		Name of the filter element to place in the beam (checks switches).

Table 21: VIRCAM@VISTA science template VIRCAM_img_obs_tile<N> parameters. Parameter which are typically updated by users are highlighted.

P2PP Label	FITS header Parameter	Type	Range	Default	Description
(List of) DET.DIT	DET1.DIT	numlist	0.0..3600.0	–	Single integration time in seconds or list of times for each filter
(List of) DET.NDIT	DET1.NDIT	intlist	ISF IR.NDIT.RANGE	–	Single NDIT or list of NDITs for each filter
Name of jitter pattern	SEQ.JITTER.ID	parameter	ISF JIT- TER_RANGE, RANDOM	–	Name of jitter pattern as listed in instrument package
Maximum size of jitter	SEQ.JITTER.MAX	number	0.0..150.0	20.0	Maximum size of a randomized jitter (in arcseconds)
Number of jitters	SEQ.JITTER.NJITTER	number	1..100	5	Number of points in a randomized jitter
Jitter scale multiplier	SEQ.JITTER.SCALE	number	0.0..10.0	1.0	Multiplier for each jitter step (1=normal)
Nesting	SEQ.NESTING	parameter	FPJME PFJME FJPME	FPJME	Filter Pawprint Jitter Microstep Exposure nesting (FPJME PFJME FJPME)
Guide star setup file for pawprint 1, . . . ,6 (from SADT)	SEQ.REF.FILE1	paramfile	–	–	A TCS setup file defining new AG and AO stars for each pawprint
Name of tile pattern (from SADT)	SEQ.TILE.ID	parameter	ISF TILE_RANGE1	ISF TILE_DEFAULT1	Name of tile pattern as listed in instrument package
Scale factor	SEQ.TILE.SCALE	number	0.0..10.0	1.0	Multiplication factor for each tile step (1=normal overlap)
Name of microstep pattern	SEQ.USTEP.ID	parameter	ISF USTEP_RANGE	Single	Name of microstep pattern
List of science filters	INS.FILTER.NAME	parameterlist	ISF FILTERS_SCI	–	List of science filters to be sequenced
Is object extended?	OCS.EXTENDED	parameter	DEFAULT, EXTENDED, SKY	DEFAULT	Is object extended?

Table 22: VIRCAM@VISTA paw print template VIRCAM_img_obs_paw and photometric standard star template VIRCAM_img_cal_std parameters. Parameter which are typically updated by users are highlighted.

P2PP Label	Parameter	Type	Range	Default	Description
(List of) integration time(s)	DET1.DIT	numlist	0.0..3600.0	–	Single integration time in seconds or list of times for each filter
(List of) number of integrations	DET1.NDIT	intlist	ISF IR.NDIT.RANGE	–	Single NDIT or list of NDITs for each filter
Name of jitter pattern	SEQ.JITTER.ID	parameter	ISF JITTER_RANGE, RANDOM	–	Name of jitter pattern as listed in instrument package
Maximum size of jitter	SEQ.JITTER.MAX	number	0.0..150.0	20.0	Maximum size of a randomized jitter (in arcseconds)
Number of jitters	SEQ.JITTER.NJITTER	number	1..100	5	Number of points in a randomized jitter
Jitter scale multiplier	SEQ.JITTER.SCALE	number	0.0..10.0	1.0	Multiplier for each jitter step (1=normal)
Nesting	SEQ.NESTING	parameter	FPJME PFJME FJPME	FPJME	Filter Pawprint Jitter Microstep Exposure nesting (FPJME PFJME FJPME)
Name of microstep pattern	SEQ.USTEP.ID	parameter	ISF USTEP_RANGE	Single	Name of microstep pattern
List of science filters	INS.FILTER.NAME	parameterlist	ISF FILTERS_SCI	–	List of science filters to be sequenced
Is object extended?	OCS.EXTENDED	boolean	DEFAULT, TENDED, SKY	EX- DEFAULT	Is object extended?

Table 23: VIRCAM@VISTA illumination correction template VIRCAM_img_cal_illumination parameters.

P2PP Label	Parameter	Type	Range	Default	Description
(List of) integration time(s)	DET1.DIT	numlist	0.0..3600.0	10.0	Single integration time in seconds or list of times for each filter
(List of) number of integrations	DET1.NDIT	intlist	ISF IR.NDIT.RANGE	1	Single NDIT or list of NDITs for each filter
List of tel. RA offsets (arcsec)	SEQ.OFFSETALPHA	numlist	-6000.0..6000.0	ISF CCD.POSITIONS.X	VISTA uses absolute offsets from the original target coordinates
List of tel. DEL offsets (arcsec)	SEQ.OFFSETDELTA	numlist	-6000.0..6000.0	ISF CCD.POSITIONS.Y	VISTA uses absolute offsets from the original target coordinates
List of tel. rotator offsets (degrees)	SEQ.OFFSETROT	numlist	-180.0..180.0	0.0	VISTA uses absolute offsets from the original target coordinates
List of science filters	INS.FILTER.NAME	parameterlist	ISF FILTERS.SCI	ISF FILTERS.SCI	List of science filters to be sequenced
Is object extended?	OCS.EXTENDED	boolean	DEFAULT, EXTENDED, SKY	DEFAULT	Is object extended?

B VISTA/VIRCAM Observing Blocks Cookbook

This section is primarily meant as a guideline for first time users or re-refresh for the other users of P2PP and SADT:

- Download SADT and P2PP from Phase 2 web pages:
<http://www.eso.org/sci/observing/phase2/SMGuidelines/SADT.html>
<http://www.eso.org/sci/observing/phase2/P2PPSurveys.html>
- Install P2PP and SADT (in this order because you need to know the path to the instrument package which comes with the P2PP). Make sure that SADT points to the instrument package downloaded with P2PP (see instructions on the download page).
- Look at the parameters like the tile pattern, jitter pattern, jitter scale multiplier, and scale factor in the templates and decide on the X and Y overlap and maximum jitter amplitude in the SADT.
- After selecting the tile pattern and jitter amplitude, run SADT and define the tiles for the survey.
- Switch on the *Find AO/AG stars* in the SADT under *Options* menu and run SADT search for the AG/AO stars. Save the resulting survey file in xml format.
- Open P2PP, select the VIRCAM observing run, and create a container (if needed!); then select container and create a new OB. If containers are not needed, then directly make a template OB under the current VIRCAM run folder.
- In this template OB select templates to use and set the desired parameters (i.e., filters in acquisition and in observing template, DIT, NDIT and jittering pattern and size). There are two possible types of observation blocks:

The first type requires the preparation of a survey area before getting started. In this case a large number of parameters will be properly set when importing the xml-output file of SADT. To get started it is required to prepare only a template OB with the proper settings in respect to filter, jitter patterns, exposure times, constraints set and time intervals. The OB for a typical wide field survey would look like the following (tileN can be one of tile1, tile3 and tile6 — only the tile6 one would provide a full coverage of the field of view):

VIRCAM_img_acq_tile	
VIRCAM_img_obs_tileN	<i>1st filter</i>
VIRCAM_img_obs_tileN	<i>2nd filter (optional)</i>
VIRCAM_img_obs_tileN	<i>3rd filter (optional)</i>

For observations of crowded areas or object with extended sources comparable with the usual offsets, it is possible to obtain clear sky images interleaved with the target images with the template:

VIRCAM_img_acq_tile6sky

Finally, it is also possible to define an OB which would take a jitter-sequence on a user defined position (covering only a third part of the VIRCAM field of view):

VIRCAM_img_acq_quick	
VIRCAM_img_obs_paw	<i>or</i>
VIRCAM_img_cal_std	<i>or</i>
VIRCAM_img_cal_illumination	

In the latter case it will be required to provide the xy-offsets to center the target on one of the detectors, if it is not intended to center the user provided field coordinates between the detectors in the center of the field of view of the camera.

- After the relevant template parameters are set, remember to set the User priority under schedule tab on P2PP main window.
- After all the parameters of the template OB are set, selecting this OB run “File” ⇒ “Import Survey Definition” to create final OBs, but updating the coordinates and importing the relevant information about guide stars.
- Revise the user priorities, and if relevant, define time delays for the time-linked OBs, and group contributions for the OBs combined in groups.
- Finally prepare the README and submit OBs.
- In addition to the above “cookbook” steps you can also look at the manuals/tutorials on how to prepare the Survey Area and OBs, available at:
<http://www.eso.org/sci/observing/phase2/SMGuidelines/SADT.html>
<http://www.eso.org/sci/observing/phase2/P2PPSurveys.html>
- Since it is not guaranteed that your preparation would survive all future changes at software and template level: Export all OBs and containers and save the resulting ascii files at a convenient place on your computer.

C VISTA@VIRCAM FITS Header Description

This section contains an example of VISTA@VIRCAM FITS header generated from a science observation.

The VISTA@VIRCAM headers use the standard ESO hierarchical structure. A suit of stand-alone FITS Tools in ANSI C is available from the ESO website (<http://archive.eso.org/saft/>) to facilitate display of the header content, and conversion to other formats (i.e., for IRAF use *hierarch28*).

```

SIMPLE =                T / IMAGE extension
BITPIX =                32 / # of bits per pix value
NAXIS =                 2 / # of axes in data array
NAXIS1 =                2048 / # of pixels in axis1
NAXIS2 =                2048 / # of pixels in axis2
PCOUNT =                0 / number of random group parameters
GCOUNT =                1 / number of random groups
EXTNAME = 'DET1.CHIP1' / Extension name
ORIGIN = 'ESO' / European Southern Observatory
DATE = '2009-08-11T04:54:19.8443' / Date this file was written
EXPTIME =                50.0000000 / Integration time
MJD-OBS =                55054.20368050 / Obs start
DATE-OBS= '2009-08-11T04:53:17.9884' / Observing date
CTYPE1 = 'RA---ZPN' / Coordinate/projection type
CTYPE2 = 'DEC--ZPN' / Coordinate/projection type
CRVAL1 =                342.734299997361 / Coordinate value at ref pixel
CRVAL2 =                -40.1412983319488 / Coordinate value at ref pixel
CRPIX1 =                5388.6 / Pixel coordinate at ref point
CRPIX2 =                6847.8 / Pixel coordinate at ref point
ORIGFILE= 'VIRCAM_IMG_OBS223_0016_DET01.fits' / Original File Name
CD1_1 = -9.47983053801822E-05 / WCS transform matrix element
CD1_2 = 7.27998866955548E-08 / WCS transform matrix element
CD2_1 = -7.27998866955548E-08 / WCS transform matrix element
CD2_2 = -9.47983053801822E-05 / WCS transform matrix element
PV2_1 =                1. / WCS parameter value term
PV2_2 =                0. / WCS parameter value term
PV2_3 =                42. / WCS parameter value term
PV2_4 =                0. / WCS parameter value term
PV2_5 =                -10000. / WCS parameter value term
CHECKSUM= 'UJp1aHo0WHo0aHo0' / ASCII 1's complement checksum
DATASUM = '1704464255' / data unit checksum updated 2009-08-11T
HIERARCH ESO DET CHIP ID = 'ESO-Virgo35' / Detector ID
HIERARCH ESO DET CHIP LIVE = T / Detector live or broken
HIERARCH ESO DET CHIP NAME = 'Virgo' / Detector name
HIERARCH ESO DET CHIP NO = 1 / Unique Detector Number
HIERARCH ESO DET CHIP NX = 2048 / Pixels in X
HIERARCH ESO DET CHIP NY = 2048 / Pixels in Y
HIERARCH ESO DET CHIP PXSPACE= 2.000e-05 / Pixel-Pixel Spacing
HIERARCH ESO DET CHIP TYPE = 'IR' / The Type of Det Chip
HIERARCH ESO DET CHIP VIGNETD= F / Detector chip vignetted?
HIERARCH ESO DET CHIP X = 1 / Detector position x-axis
HIERARCH ESO DET CHIP Y = 4 / Detector position y-axis
HIERARCH ESO DET CHOP FREQ = 0 / Chopping Frequency
HIERARCH ESO DET CON OPMODE = 'NORMAL' / Operational Mode
HIERARCH ESO DET DID = 'ESO-VLT-DIC.IRACE-1.47' / Dictionary Name and Re
HIERARCH ESO DET DIT = 10.0000000 / Integration Time
HIERARCH ESO DET DITDELAY = 0.000 / Pause Between DITs
HIERARCH ESO DET EXP NAME = 'VIRCAM_IMG_OBS223_0016' / Exposure Name
HIERARCH ESO DET EXP NO = 640 / Exposure number
HIERARCH ESO DET EXP UTC = '2009-08-11T04:54:19.8443' / File Creation Time
HIERARCH ESO DET FILE CUBE ST= F / Data Cube On/Off
HIERARCH ESO DET FRAM NO = 1 / Frame number
HIERARCH ESO DET FRAM TYPE = 'INT' / Frame type

```



```

HIERARCH ESO DET FRAM UTC      = '2009-08-11T04:54:19.5302' / Time Recv Frame
HIERARCH ESO DET IRACE ADC1 DELAY=      7 / ADC Delay Adjustment
HIERARCH ESO DET IRACE ADC1 ENABLE=     1 / Enable ADC Board (0/1)
HIERARCH ESO DET IRACE ADC1 FILTER1=    0 / ADC Filter1 Adjustment
HIERARCH ESO DET IRACE ADC1 FILTER2=    0 / ADC Filter2 Adjustment
HIERARCH ESO DET IRACE ADC1 HEADER=     1 / Header of ADC Board
HIERARCH ESO DET IRACE ADC1 NAME= 'VISTA-AQ-GRP' / Name for ADC Board
... similar entries for IRACE ADC2 to IRACE ADC15 are omitted ...
HIERARCH ESO DET IRACE ADC16 DELAY=     7 / ADC Delay Adjustment
HIERARCH ESO DET IRACE ADC16 ENABLE=    1 / Enable ADC Board (0/1)
HIERARCH ESO DET IRACE ADC16 FILTER1=   0 / ADC Filter1 Adjustment
HIERARCH ESO DET IRACE ADC16 FILTER2=   0 / ADC Filter2 Adjustment
HIERARCH ESO DET IRACE ADC16 HEADER=    1 / Header of ADC Board
HIERARCH ESO DET IRACE ADC16 NAME= 'VISTA-AQ-GRP' / Name for ADC Board
HIERARCH ESO DET IRACE SEQCONT=         F / Sequencer Continuous Mode
HIERARCH ESO DET MINDIT      =      1.0011000 / Minimum DIT
HIERARCH ESO DET MODE NAME  = '      ' / DCS Detector Mode
HIERARCH ESO DET NCORRS     =           3 / Read-Out Mode
HIERARCH ESO DET NCORRS NAME = 'Double ' / Read-Out Mode Name
HIERARCH ESO DET NDIT       =           5 / # of Sub-Integrations
HIERARCH ESO DET NDITSKIP   =           0 / DITs skipped at 1st.INT
HIERARCH ESO DET RSPEED     =           1 / Read-Speed Factor
HIERARCH ESO DET RSPEEDADD  =           0 / Read-Speed Add
HIERARCH ESO DET WIN NX     =          2048 / # of Pixels in X
HIERARCH ESO DET WIN NY     =          2048 / # of Pixels in Y
HIERARCH ESO DET WIN STARTX =           1 / Lower left X ref
HIERARCH ESO DET WIN STARTY =           1 / Lower left Y ref
HIERARCH ESO DET WIN TYPE   =           0 / Win-Type: 0=SW/1=HW
COMMENT -----
COMMENT Information from Primary Header
COMMENT -----
ROOTHEAD=          T          / Standard FITS (NOST-100-2.0)
ORIGIN  = 'ESO      '        / European Southern Observatory
DATE    = '2009-08-11T04:53:17' / Date this file was written
TELESCOP= 'VISTA  '        / ESO Telescope Name
INSTRUME= 'VIRCAM '        / Instrument used.
OBJECT  = 'DS      '        / Original target.
RA      =          342.734300 / 22:50:56.2 RA (J2000) pointing (deg)
DEC     =          -40.14130  / -40:08:28.6 DEC (J2000) pointing (deg)
EQUINOX =          2000.     / Standard FK5 (years)
RADECSYS= 'FK5    '        / Coordinate reference frame
EXPTIME =          50.000000 / Integration time
MJD-OBS =          55054.20368050 / Obs start
DATE-OBS= '2009-08-11T04:53:17.9884' / Observing date
UTC     =          17596.000 / 04:53:16.000 UTC at start (sec)
LST    =          77451.583 / 21:30:51.583 LST at start (sec)
PI-COI  = 'UNKNOWN '        / PI-COI name.
OBSERVER= 'UNKNOWN '        / Name of observer.
ORIGFILE= 'VIRCAM_IMG_OBS223_0016.fits' / Original File Name
JITTER_I=          3         / Sequence number of jitter
JITTER_X=          13.660    / X offset in jitter pattern [arcsec]
JITTER_Y=          3.660    / Y offset in jitter pattern [arcsec]
JITTRNUM=          3         / Value of 1st OBSNUM in jitter seq
JITTR_ID= 'Jitter5z'        / Name of jitter pattern
NJITTER =          5         / Number of jitter positions
NOFFSETS=          6         / Number of offset positions
NUSTEP  =          1         / Number of microstep positions
OBSNUM  =          16        / Observation number
OFFSET_I=          2         / Sequence number of offset
OFFSET_X=          -329.779  / X offset [arcsec]
OFFSET_Y=          0.000    / Y offset [arcsec]
OFFSTNUM=          15        / First OBSNUM in offset sequence
OFFST_ID= 'Tile6n '        / Name of offset pattern

```

```

RECIPE = 'DEFAULT ' / Data reduction recipe to be used
REQTIME = 10.000 / Requested integration time [s]
USTEPNUM= 16 / Value of 1st OBSNUM in ustep seq
USTEP_I = 1 / Sequence number of ustep
USTEP_ID= 'Single ' / Name of ustep pattern
USTEP_X = 0.000 / X offset in ustep pattern [arcsec]
USTEP_Y = 0.000 / Y offset in ustep pattern [arcsec]
ARCFILE = 'VCAM.2009-08-11T04:53:17.995.fits' / Archive File Name
CHECKSUM= 'JA5pL35mJA5mJ35m' / ASCII 1's complement checksum
DATASUM = '0 ' / data unit checksum updated 2009-08-11T
HIERARCH ESO OBS DID = 'ESO-VLT-DIC.OBS-1.11' / OBS Dictionary
HIERARCH ESO OBS EXEETIME = 0 / Expected execution time
HIERARCH ESO OBS GRP = '0 ' / linked blocks
HIERARCH ESO OBS ID = 378057 / Observation block ID
HIERARCH ESO OBS NAME = 'EV_DS1_1_1_1-J' / OB name
HIERARCH ESO OBS OBSERVER = 'UNKNOWN ' / Observer Name
HIERARCH ESO OBS PI-COI ID = 70033 / ESO internal PI-COI ID
HIERARCH ESO OBS PI-COI NAME = 'UNKNOWN ' / PI-COI name
HIERARCH ESO OBS PROG ID = '60.A-9292(A)' / ESO program identification
HIERARCH ESO OBS START = '2009-08-11T04:37:23' / OB start time
HIERARCH ESO OBS TARG NAME = 'DS ' / OB target name
HIERARCH ESO OBS TPLNO = 2 / Template number within OB
HIERARCH ESO TPL DID = 'ESO-VLT-DIC.TPL-1.9' / Data dictionary for TPL
HIERARCH ESO TPL EXPNO = 14 / Exposure number within template
HIERARCH ESO TPL FILE DIRNAME= '$INS_ROOT/$INS_USER/MISC/VISTA' / Storage filena
HIERARCH ESO TPL ID = 'VIRCAM_img_obs_tile6' / Template signature ID
HIERARCH ESO TPL NAME = 'VIRCAM tile 6 observation' / Template name
HIERARCH ESO TPL NEXP = 30 / Number of exposures within templat
HIERARCH ESO TPL PRESEQ = 'VIRCAM_img_obs_tile.seq' / Sequencer script
HIERARCH ESO TPL START = '2009-08-11T04:37:33' / TPL start time
HIERARCH ESO TPL VERSION = '$Revision: 1.42 $' / Version of the template
HIERARCH ESO DPR CATG = 'SCIENCE ' / Observation category
HIERARCH ESO DPR TECH = 'IMAGE,JITTER' / Observation technique
HIERARCH ESO DPR TYPE = 'OBJECT ' / Observation type
HIERARCH ESO TEL ABSROT END = 29.156065 / Abs rotator angle at end
HIERARCH ESO TEL ABSROT START= 28.715680 / Abs rotator angle at start
HIERARCH ESO TEL AG REFY = 1666.741 / Autoguider reference pixel X
HIERARCH ESO TEL AG REFY = 465.686 / Autoguider reference pixel Y
HIERARCH ESO TEL AIRM END = 1.084 / Airmass at end
HIERARCH ESO TEL AIRM START = 1.085 / Airmass at start
HIERARCH ESO TEL ALT = 67.096 / Alt angle at start (deg)
HIERARCH ESO TEL AMBI FWHM END= 0.79 / Observatory Seeing queried from AS
HIERARCH ESO TEL AMBI FWHM START= 0.73 / Observatory Seeing queried from AS
HIERARCH ESO TEL AMBI PRES END= 738.43 / Observatory ambient air pressure q
HIERARCH ESO TEL AMBI PRES START= 738.43 / Observatory ambient air pressure q
HIERARCH ESO TEL AMBI RHUM = 4. / Observatory ambient relative humi
HIERARCH ESO TEL AMBI TAUO = 0.004422 / Average coherence time
HIERARCH ESO TEL AMBI TEMP = 14.34 / Observatory ambient temperature qu
HIERARCH ESO TEL AMBI WINDDIR= 336. / Observatory ambient wind directio
HIERARCH ESO TEL AMBI WINDSP = 3.59 / Observatory ambient wind speed que
HIERARCH ESO TEL AO ALT = 67.206236 / Altitude of last closed loop a0
HIERARCH ESO TEL AO DATE = '2009-08-11T04:54:00' / Last closed loop a0
HIERARCH ESO TEL AO M1 DATE = '2009-08-11T04:54:00' / Last M1 update
HIERARCH ESO TEL AO M2 DATE = '2009-08-11T04:54:05' / Last M2 update
HIERARCH ESO TEL AO MODES = 15 / Which a0 modes corrected closed lo
HIERARCH ESO TEL AZ = 317.336 / Az angle at start (deg) S=0,W=90
HIERARCH ESO TEL DATE = 'not set ' / TCS installation date
HIERARCH ESO TEL DID = 'ESO-VLT-DIC.TCS-01.00' / Data dictionary for TEL
HIERARCH ESO TEL DID1 = 'ESO-VLT-DIC.VTCS-0.2' / Additional data dict. fo
HIERARCH ESO TEL DOME STATUS = 'FULLY-OPEN' / Dome status
HIERARCH ESO TEL ECS FLATFIELD= 0 / Flat field level
HIERARCH ESO TEL ECS MOONSCR = 0.58 / Moon screen position
HIERARCH ESO TEL ECS VENT1 = 1.00 / State of vent i

```

```

HIERARCH ESO TEL ECS VENT2 = 1.00 / State of vent i
HIERARCH ESO TEL ECS VENT3 = 1.00 / State of vent i
HIERARCH ESO TEL ECS WINDSCR = 1.00 / Wind screen position
HIERARCH ESO TEL FOCU ID = 'CA ' / Telescope focus station ID
HIERARCH ESO TEL FOCU VALUE = 2.617 / M2 setting (mm)
HIERARCH ESO TEL GEOELEV = 2530. / Elevation above sea level (m)
HIERARCH ESO TEL GEOLAT = -24.6157 / Tel geo latitude (+=North) (deg)
HIERARCH ESO TEL GEOLON = -70.3976 / Tel geo longitude (+=East) (deg)
HIERARCH ESO TEL GUID DEC = -39.98310 / Guide star DEC J2000
HIERARCH ESO TEL GUID FWHM = 1.09 / Seeing measured by autoguider
HIERARCH ESO TEL GUID ID = 'PY ' / Guider ID
HIERARCH ESO TEL GUID MAG = 13.60 / Magnitude of guide star
HIERARCH ESO TEL GUID PEAKINT= 0.00 / Peak intensity of guide star
HIERARCH ESO TEL GUID RA = 343.632454 / Guide star RA J2000
HIERARCH ESO TEL GUID STATUS= 'ON ' / Status of autoguider
HIERARCH ESO TEL ID = 'v 0.101 ' / TCS version number
HIERARCH ESO TEL M2 ACENTRE = -32.40 / M2 centring alpha
HIERARCH ESO TEL M2 ATILT = 35.35 / M2 tilt alpha
HIERARCH ESO TEL M2 BCENTRE = 102.30 / M2 centring beta
HIERARCH ESO TEL M2 BTILT = 54.49 / M2 tilt beta
HIERARCH ESO TEL M2 Z = 2.61723 / Focussing position of M2 in Z coor
HIERARCH ESO TEL MOON DEC = 11.92595 / 11:55:33.4 DEC (J2000) (deg)
HIERARCH ESO TEL MOON RA = 14.421736 / 00:57:41.2 RA (J2000) (deg)
HIERARCH ESO TEL OPER = 'Operator name not set' / Telescope Operator
HIERARCH ESO TEL PARANG END = -53.191 / Parallax angle at end (deg)
HIERARCH ESO TEL PARANG START= -53.624 / Parallax angle at start (deg)
HIERARCH ESO TEL POSANG = -89.956000 / Rot position angle at start
HIERARCH ESO TEL TARG ALPHA = 225056.232 / Alpha coordinate for the target
HIERARCH ESO TEL TARG COORDTYPE= 'M ' / Coordinate type (M=mean A=apparent)
HIERARCH ESO TEL TARG DELTA = -400828.674 / Delta coordinate for the target
HIERARCH ESO TEL TARG EPOCH = 2000.000 / Epoch
HIERARCH ESO TEL TARG EPOCHSYSTEM= 'J ' / Epoch system (default J=Julian)
HIERARCH ESO TEL TARG EQUINOX= 2000.000 / Equinox
HIERARCH ESO TEL TARG PARALLAX= 0.000 / Parallax
HIERARCH ESO TEL TARG PMA = 0.000000 / Proper Motion Alpha
HIERARCH ESO TEL TARG PMD = 0.000000 / Proper motion Delta
HIERARCH ESO TEL TARG RADVEL = 0.000 / Radial velocity
HIERARCH ESO TEL TH M1 TEMP = 14.13 / M1 superficial temperature
HIERARCH ESO TEL TH STR TEMP = 14.55 / Telescope structure temperature
HIERARCH ESO TEL TRAK STATUS = 'NORMAL ' / Tracking status
HIERARCH ESO INS DATE = '2009-06-05' / Instrument release date (yyyy-mm-d)
HIERARCH ESO INS FILT1 DATE = '2009-07-25T02:31:14' / Filter index time
HIERARCH ESO INS FILT1 ENC = 105866 / Filter wheel abs position [Enc]
HIERARCH ESO INS FILT1 ERROR = 2.0 / Filter home switch offset [Enc]
HIERARCH ESO INS FILT1 FOCUS = 0.000 / Filter focus offset [mm]
HIERARCH ESO INS FILT1 ID = 'SLOT5 ' / Filter slot name
HIERARCH ESO INS FILT1 NAME = 'J ' / Filter name
HIERARCH ESO INS FILT1 NO = 17 / Filter wheel position index
HIERARCH ESO INS FILT1 POSEGE= -106841 / In-position switch edge [Enc]
HIERARCH ESO INS FILT1 TRAYID= 'ESO-J-0002' / Filter tray ID
HIERARCH ESO INS FILT1 WLEN = 1250.000 / Filter effective wavelength [nm]
HIERARCH ESO INS HB1 SWSIM = F / If T, heart beat device simulated
HIERARCH ESO INS ID = 'VIRCAM/1.57' / Instrument ID
HIERARCH ESO INS LSC1 OK = T / If T, controller is operational
HIERARCH ESO INS LSC1 SWSIM = F / If T, lakeshore ctrllr simulated
HIERARCH ESO INS LSM1 OK = T / If T, controller is operational
HIERARCH ESO INS LSM1 SWSIM = F / If T, lakeshore monitor simulated
HIERARCH ESO INS LSM2 OK = F / If T, controller is operational
HIERARCH ESO INS LSM2 SWSIM = F / If T, lakeshore monitor simulated
HIERARCH ESO INS LSM3 OK = T / If T, controller is operational
HIERARCH ESO INS LSM3 SWSIM = F / If T, lakeshore monitor simulated
HIERARCH ESO INS PRES1 ID = 'Vac1 ' / Pressure sensor type
HIERARCH ESO INS PRES1 NAME = 'Vacuum gauge 1' / Pressure sensor name

```

```

HIERARCH ESO INS PRES1 UNIT = 'mbar ' / Pressure unit
HIERARCH ESO INS PRES1 VAL = 9999.000 / Pressure [mbar]
HIERARCH ESO INS SW1 ID = 'INPOS ' / Switch ID
HIERARCH ESO INS SW1 NAME = 'Filter In-position Switch' / Switch name
HIERARCH ESO INS SW1 STATUS = 'ACTIVE ' / Switch status
HIERARCH ESO INS SW2 ID = 'REFSW ' / Switch ID
HIERARCH ESO INS SW2 NAME = 'Filter Reference Select' / Switch name
HIERARCH ESO INS SW2 STATUS = 'PRIMARY ' / Switch status
HIERARCH ESO INS SW3 ID = 'HOME ' / Switch ID
HIERARCH ESO INS SW3 NAME = 'Filter Reference Switch' / Switch name
HIERARCH ESO INS SW3 STATUS = 'INACTIVE' / Switch status
HIERARCH ESO INS TEMP1 ID = 'Amb ' / Temperature sensor type
HIERARCH ESO INS TEMP1 NAME = 'Ambient temperature' / Temperature sensor name
HIERARCH ESO INS TEMP1 UNIT = 'K ' / Temperature unit
HIERARCH ESO INS TEMP1 VAL = 289.010 / Temperature [K]
HIERARCH ESO INS TEMP10 ID = 'CC1_2 ' / Temperature sensor type
HIERARCH ESO INS TEMP10 NAME = 'Cryo cooler 1 2nd' / Temperature sensor name
HIERARCH ESO INS TEMP10 UNIT = 'K ' / Temperature unit
HIERARCH ESO INS TEMP10 VAL = 9999.000 / Temperature [K]
HIERARCH ESO INS TEMP12 ID = 'CC2_2 ' / Temperature sensor type
HIERARCH ESO INS TEMP12 NAME = 'Cryo cooler 2 2nd' / Temperature sensor name
HIERARCH ESO INS TEMP12 UNIT = 'K ' / Temperature unit
HIERARCH ESO INS TEMP12 VAL = 9999.000 / Temperature [K]
HIERARCH ESO INS TEMP14 ID = 'CC3_2 ' / Temperature sensor type
HIERARCH ESO INS TEMP14 NAME = 'Cryo cooler 3 2nd' / Temperature sensor name
HIERARCH ESO INS TEMP14 UNIT = 'K ' / Temperature unit
HIERARCH ESO INS TEMP14 VAL = 9999.000 / Temperature [K]
HIERARCH ESO INS TEMP15 ID = 'WFS1 ' / Temperature sensor type
HIERARCH ESO INS TEMP15 NAME = 'WFS CCD assembly PY' / Temperature sensor name
HIERARCH ESO INS TEMP15 UNIT = 'K ' / Temperature unit
HIERARCH ESO INS TEMP15 VAL = 9999.000 / Temperature [K]
HIERARCH ESO INS TEMP16 ID = 'WFS2 ' / Temperature sensor type
HIERARCH ESO INS TEMP16 NAME = 'WFS CCD assembly NY' / Temperature sensor name
HIERARCH ESO INS TEMP16 UNIT = 'K ' / Temperature unit
HIERARCH ESO INS TEMP16 VAL = 9999.000 / Temperature [K]
HIERARCH ESO INS TEMP17 ID = 'Dt1AB ' / Temperature sensor type
HIERARCH ESO INS TEMP17 NAME = 'Science detector 1AB' / Temperature sensor name
HIERARCH ESO INS TEMP17 UNIT = 'K ' / Temperature unit
HIERARCH ESO INS TEMP17 VAL = 71.281 / Temperature [K]
HIERARCH ESO INS TEMP18 ID = 'Dt1CD ' / Temperature sensor type
HIERARCH ESO INS TEMP18 NAME = 'Science detector 1CD' / Temperature sensor name
HIERARCH ESO INS TEMP18 UNIT = 'K ' / Temperature unit
HIERARCH ESO INS TEMP18 VAL = 70.829 / Temperature [K]
HIERARCH ESO INS TEMP19 ID = 'Dt2BA ' / Temperature sensor type
HIERARCH ESO INS TEMP19 NAME = 'Science detector 2BA' / Temperature sensor name
HIERARCH ESO INS TEMP19 UNIT = 'K ' / Temperature unit
HIERARCH ESO INS TEMP19 VAL = 72.188 / Temperature [K]
HIERARCH ESO INS TEMP2 ID = 'Win ' / Temperature sensor type
HIERARCH ESO INS TEMP2 NAME = 'Cryostat window cell' / Temperature sensor name
HIERARCH ESO INS TEMP2 UNIT = 'K ' / Temperature unit
HIERARCH ESO INS TEMP2 VAL = 289.840 / Temperature [K]
HIERARCH ESO INS TEMP20 ID = 'Dt2DC ' / Temperature sensor type
HIERARCH ESO INS TEMP20 NAME = 'Science detector 2DC' / Temperature sensor name
HIERARCH ESO INS TEMP20 UNIT = 'K ' / Temperature unit
HIERARCH ESO INS TEMP20 VAL = 71.884 / Temperature [K]
HIERARCH ESO INS TEMP21 ID = 'Dt3AB ' / Temperature sensor type
HIERARCH ESO INS TEMP21 NAME = 'Science detector 3AB' / Temperature sensor name
HIERARCH ESO INS TEMP21 UNIT = 'K ' / Temperature unit
HIERARCH ESO INS TEMP21 VAL = 72.235 / Temperature [K]
HIERARCH ESO INS TEMP22 ID = 'Dt3CD ' / Temperature sensor type
HIERARCH ESO INS TEMP22 NAME = 'Science detector 3CD' / Temperature sensor name
HIERARCH ESO INS TEMP22 UNIT = 'K ' / Temperature unit
HIERARCH ESO INS TEMP22 VAL = 72.957 / Temperature [K]

```

```

HIERARCH ESO INS TEMP23 ID = 'Dt4BA ' / Temperature sensor type
HIERARCH ESO INS TEMP23 NAME = 'Science detector 4BA' / Temperature sensor name
HIERARCH ESO INS TEMP23 UNIT = 'K ' / Temperature unit
HIERARCH ESO INS TEMP23 VAL = 72.305 / Temperature [K]
HIERARCH ESO INS TEMP24 ID = 'Dt4DC ' / Temperature sensor type
HIERARCH ESO INS TEMP24 NAME = 'Science detector 4DC' / Temperature sensor name
HIERARCH ESO INS TEMP24 UNIT = 'K ' / Temperature unit
HIERARCH ESO INS TEMP24 VAL = 72.112 / Temperature [K]
HIERARCH ESO INS TEMP25 ID = 'FPA ' / Temperature sensor type
HIERARCH ESO INS TEMP25 NAME = 'FPA thermal plate' / Temperature sensor name
HIERARCH ESO INS TEMP25 UNIT = 'K ' / Temperature unit
HIERARCH ESO INS TEMP25 VAL = 67.874 / Temperature [K]
HIERARCH ESO INS TEMP26 ID = 'WFSpl ' / Temperature sensor type
HIERARCH ESO INS TEMP26 NAME = 'WFS plate' / Temperature sensor name
HIERARCH ESO INS TEMP26 UNIT = 'K ' / Temperature unit
HIERARCH ESO INS TEMP26 VAL = 95.801 / Temperature [K]
HIERARCH ESO INS TEMP3 ID = 'Tube ' / Temperature sensor type
HIERARCH ESO INS TEMP3 NAME = 'Cryostat tube' / Temperature sensor name
HIERARCH ESO INS TEMP3 UNIT = 'K ' / Temperature unit
HIERARCH ESO INS TEMP3 VAL = 287.910 / Temperature [K]
HIERARCH ESO INS TEMP4 ID = 'OBtop ' / Temperature sensor type
HIERARCH ESO INS TEMP4 NAME = 'Optical Bench Top' / Temperature sensor name
HIERARCH ESO INS TEMP4 UNIT = 'K ' / Temperature unit
HIERARCH ESO INS TEMP4 VAL = 92.781 / Temperature [K]
HIERARCH ESO INS TEMP5 ID = 'Baff ' / Temperature sensor type
HIERARCH ESO INS TEMP5 NAME = 'Baffle ' / Temperature sensor name
HIERARCH ESO INS TEMP5 UNIT = 'K ' / Temperature unit
HIERARCH ESO INS TEMP5 VAL = 148.360 / Temperature [K]
HIERARCH ESO INS TEMP6 ID = 'Lens ' / Temperature sensor type
HIERARCH ESO INS TEMP6 NAME = 'Lens barrel' / Temperature sensor name
HIERARCH ESO INS TEMP6 UNIT = 'K ' / Temperature unit
HIERARCH ESO INS TEMP6 VAL = 89.823 / Temperature [K]
HIERARCH ESO INS TEMP7 ID = 'FwShd ' / Temperature sensor type
HIERARCH ESO INS TEMP7 NAME = 'Filter wheel shield' / Temperature sensor name
HIERARCH ESO INS TEMP7 UNIT = 'K ' / Temperature unit
HIERARCH ESO INS TEMP7 VAL = 109.230 / Temperature [K]
HIERARCH ESO INS TEMP8 ID = 'FwHub ' / Temperature sensor type
HIERARCH ESO INS TEMP8 NAME = 'Filter wheel hub' / Temperature sensor name
HIERARCH ESO INS TEMP8 UNIT = 'K ' / Temperature unit
HIERARCH ESO INS TEMP8 VAL = 96.258 / Temperature [K]
HIERARCH ESO INS THERMAL AMB MEAN= 289.01 / Ambient temperature [K]
HIERARCH ESO INS THERMAL CLD MEAN= 0.00 / Cold head temperature [K]
HIERARCH ESO INS THERMAL DET MEAN= 71.98 / Detector mean temperature [K]
HIERARCH ESO INS THERMAL DET TARGET= 72.00 / Detector target temperature [K]
HIERARCH ESO INS THERMAL ENABLE= T / If T, thermal control enabled
HIERARCH ESO INS THERMAL FPA MEAN= 67.87 / Focal plane array temperature [K]
HIERARCH ESO INS THERMAL TUB MEAN= 287.91 / Tube temperature [K]
HIERARCH ESO INS THERMAL WIN MEAN= 289.85 / Window temperature [K]
HIERARCH ESO INS VAC1 OK = F / If T, controller is operational
HIERARCH ESO INS VAC1 SWSIM = F / If T, vacuum sensor simulated
HIERARCH ESO DET DIT = 10.000000 / Integration Time
HIERARCH ESO DET NCORRS NAME = 'Double ' / Read-Out Mode Name
HIERARCH ESO DET NDIT = 5 / # of Sub-Integrations
HIERARCH ESO GEN MOON RA = 14.43722 / Moon Right Ascension
HIERARCH ESO GEN MOON DEC = 11.98059 / Moon Declination
HIERARCH ESO GEN MOON DIST = 59.84113 / Moon distance to target
HIERARCH ESO GEN MOON ALT = 27.67441 / Moon altitude angle
HIERARCH ESO GEN MOON AZ = 60.12512 / Moon azimuth angle
HIERARCH ESO GEN MOON PHASE = 0.68 / Moon phase as fraction of period
HIERARCH ESO OCS DET1 IMGNAME= 'VIRCAM_IMG_OBS' / Data File Name.
HIERARCH ESO OCS EXPNO = 1 / Exposure number of dwell
HIERARCH ESO OCS NEXP = 1 / Number of exposures per dwell
HIERARCH ESO OCS RECIPE = 'DEFAULT ' / Data reduction recipe to be used

```

```
HIERARCH ESO OCS REQTIME      =      10.000 / Requested integration time [s]
HIERARCH ESO OCS SADT AOSA1 ID= 'S3303221272' / AO star A ID
HIERARCH ESO OCS SADT AOSA2 ID= 'S3303221280' / AO star A ID
HIERARCH ESO OCS SADT AOSA3 ID= 'S3303221277' / AO star A ID
HIERARCH ESO OCS SADT AOSA4 ID= 'S3303221279' / AO star A ID
HIERARCH ESO OCS SADT AOSA5 ID= 'S330322113566' / AO star A ID
HIERARCH ESO OCS SADT AOSB1 ID= 'S330322191' / AO star B ID
HIERARCH ESO OCS SADT AOSB2 ID= 'S3303231321' / AO star B ID
HIERARCH ESO OCS SADT AOSB3 ID= 'S3303231319' / AO star B ID
HIERARCH ESO OCS SADT AOSB4 ID= 'S3303231320' / AO star B ID
HIERARCH ESO OCS SADT AOSB5 ID= 'S3303231364' / AO star B ID
HIERARCH ESO OCS SADT CAT ID = 'GSC-2 at ESO' / Guide star catalogue used
HIERARCH ESO OCS SADT GS1 ID = 'S330322158' / Guide star ID
HIERARCH ESO OCS SADT IP ID  = 'SADT v3.04, VIRCAM-1.25' / Creator software vers
HIERARCH ESO OCS TARG ALPHAOBJ= 225055.896 / RA of target object [HHMMSS.TTT]
HIERARCH ESO OCS TARG DELTAOBJ= -401344.760 / Dec of target object [DDMMSS.TTT]
HIERARCH ESO OCS TARG X      =      0.00 / Pointing origin X coord [mm]
HIERARCH ESO OCS TARG Y      =      0.00 / Pointing origin Y coord [mm]
COMMENT VISTA IR Camera OS $Revision: 1.13 $
COMMENT FTU-2_5_2/2009-08-11T04:54:38/fitsTranslateTable-RAW.ht
HISTORY FTU-2_5_2/2009-08-11/ADD: GEN.MOON.RA
HISTORY FTU-2_5_2/2009-08-11/ADD: GEN.MOON.DEC
HISTORY FTU-2_5_2/2009-08-11/ADD: GEN.MOON.DIST
HISTORY FTU-2_5_2/2009-08-11/ADD: GEN.MOON.ALT
HISTORY FTU-2_5_2/2009-08-11/ADD: GEN.MOON.AZ
HISTORY FTU-2_5_2/2009-08-11/ADD: GEN.MOON.PHASE
ROOTEND =      T
COMMENT 9 blank lines
END
```