



EUROPEAN SOUTHERN OBSERVATORY

Organisation Européenne pour des Recherches Astronomiques dans l'Hémisphère Austral
Europäische Organisation für astronomische Forschung in der südlichen Hemisphäre

ESO - European Southern Observatory
Karl-Schwarzschild Str. 2, D-85748 Garching bei München

Very Large Telescope

HAWK-I User Manual

Doc. No. VLT-MAN-ESO-14800-3486

Issue 88.1
10 Jun 2011

Prepared . Giovanni Carraro and the HAWK-I IOT

Approved . C. Dumas

Name	Date	Signature
------	------	-----------

Released . A. Kaufer

Name	Date	Signature
------	------	-----------

Change Record

Issue/Rev.	Date	Section/Parag. affected	Reason/Initiation/Documents/Remarks
Issue 1	25 May 2007	all	First release for PAE
Issue 81	31 August 2007		prepared for CfP P81
	6 Dec. 2007	all	update after end of commissionings
Issue 82	06 March 2008		P82 Phase I version bump. Bug in overhead table corrected. Minor changes to introduction.
Issue 82.1	06 March 2008		minor bug
Issue 82.2	06 March 2008		Added warning about sky-subtraction.
Issue 83.0	01 Sep 2008		P83 Phase 1. cal plan.
Issue 83.1	27 Nov 2008		P83 addenda for the IP83 release.
Issue 84.0	29 May 2009		P84 addenda: New read-out mode and persistence study. Change of offset scheme.
Issue 84.1	27 Jun 2009		P84 addenda: cleaning and Phase II.
Issue 85.0	09 Dec 2009		P85 Phase I and II.
Issue 85.1	28 Feb 2010		Fast Photometry included.
Issue 86.0	30 Jun 2010		Several correction in the Appendix F.
Issue 87.0	02 Aug 2010		No changes from P86 to P87.
Issue 88.0	05 Feb 2011		Many different small changes.
Issue 88.1	10 June 2011		Many different small changes once again.

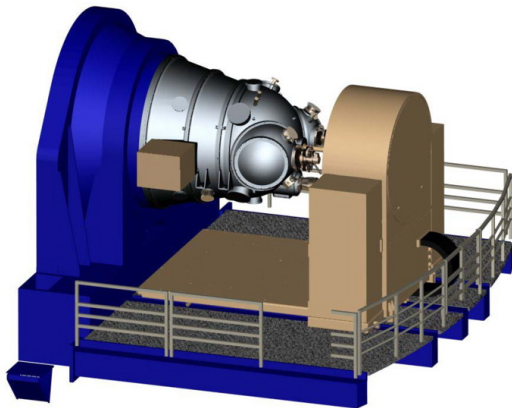

HAWK-I as a CAD drawing attached to the VLT and in the integration hall in Garching

HAWK-I in a Nutshell

Online information on HAWK-I can be found on the [instrument web pages](#) and in Kissler-Patig et al. 2008, A&A 491, 941.

HAWK-I is a near-infrared ($0.85 - 2.5 \mu\text{m}$) wide-field imager.

The instrument is cryogenic (120 K, detectors at 75 K) and has a full reflective design. The light passes four mirrors and two filter wheels before hitting a mosaic of four Hawaii 2RG 2048×2048 pixels detectors. The final F-ratio is F/4.36 ($1''$ on the sky correspond to $169.4 \mu\text{m}$).

The field of view (FoV) on the sky is $7.5' \times 7.5'$ (with a small cross-shaped gap of $\sim 15''$ between the four detectors). The pixel scale is $0.106'' / \text{pix}$. The two filter wheels of six positions each host ten filters: Y, J, H, K_s (identical to the VISTA filters), as well as 6 narrow band filters ($\text{Br}\gamma$, CH4, H2 and three cosmological filters at 1.061 , 1.187 , and $2.090 \mu\text{m}$).

Typical limiting magnitudes ($S/N=5$ in 3600s on source) are around $J= 23.9$, $H= 22.5$ and $K_s= 22.3$ mag (Vega).

Contents

1	Introduction	1
1.1	Scope of this document	1
1.2	Structure of this document	1
1.3	Glossary	1
1.4	Abbreviations and Acronyms	1
I	Observing with HAWK-I: from phase 1 to data reduction	2
2	PHASE 1: applying for observing time with HAWK-I	2
2.1	Is HAWK-I the right instrument for your project?	2
2.1.1	Field of View	2
2.1.2	Filters	3
2.1.3	Limiting magnitudes	3
2.1.4	Instrument's performance	4
2.2	Photometry with HAWK-I	4
2.2.1	Two ways to get reasonable photometry	5
2.2.2	Consider the 2MASS calibration fields	5
2.2.3	HAWK-I extinction coefficients	5
2.3	The Exposure Time Calculator	5
2.4	Proposal Form	6
2.5	Overheads and Calibration Plan	6
3	PHASE 2: Preparing your HAWK-I observations	8
3.1	HAWK-I specifics to templates, OBs, and p2pp	8
3.1.1	p2pp	8
3.1.2	Observing Blocks – OBs	8
3.1.3	Templates	8
3.2	Finding Charts and README Files	9
4	Observing (Strategies) with HAWK-I	11
4.1	Overview	11
4.2	Visitor Mode Operations	11
4.3	The influence of the Moon	11
4.4	Orientation, offset conventions and definitions	11
4.5	Instrument and telescope overheads	12
4.6	Recommended DIT/NDIT and Object–Sky pattern	13
II	Reference Material	16

A	The HAWK-I filters	16
B	The HAWK-I detectors	19
	B.1 Threshold-limited integration	20
	B.2 Detectors' structures and features	20
	B.3 Detectors' relative sensitivity	21
C	The HAWK-I Field-of-View	25
	C.1 Relative position of the four quadrants	25
	C.1.1 Center of Rotation and Centre of Pointing	25
	C.2 Vignetting of the field-of-view	26
D	The HAWK-I calibration plan	27
	D.1 Do you need special calibrations?	27
	D.2 The HAWK-I standard calibrations in a nutshell	27
	D.3 Quality Control	27
E	The HAWK-I pipeline	29
F	HAWK-I Burst and Fast Jitter Modes	30
	F.1 The Mode in Nutshell	30
	F.2 Description	30
	F.3 Timing Information	33
	F.4 Preparation and Observation	33
	F.4.1 OB Naming Convention	33
	F.4.2 OB Requirements and Finding Charts	33
	F.4.3 Observing Modes	34
	F.4.4 Calibration Plan	34
	F.4.5 FITS Files Names	34
	F.5 Template Guide	34
	F.5.1 Acquisition: <i>HAWKI_img_acq_FastPhot</i>	34
	F.5.2 Science template: <i>HAWKI_img_obs_FastPhot</i>	36
	F.5.3 Calibration templates: <i>HAWKI_img_cal_DarksFastPhot</i>	37

1 Introduction

1.1 Scope of this document

The HAWK-I user manual provides the information required for the proposal preparation (phase 1), the phase 2 observation preparation and the observation phase.

The instrument has started regular operations in period 81. We welcome any comments and suggestions on the manual; these should be addressed to our user support group at usd-help@eso.org.

1.2 Structure of this document

The document is structured in 2 parts. Part 1 (I) takes you step by step through the essentials (writing your proposal in phase 1, preparing your observations in phase 2, conducting your observations at the telescope and reducing your data). Part 2 (II) contains collected useful reference material.

1.3 Glossary

1.4 Abbreviations and Acronyms

DMO	Data Management and Operations Division
ESO	European Southern Observatory
ETC	Exposure Time Calculator
FC	Finding Chart
FoV	Field of View
FWHM	Full Width at Half Maximum
HAWK-I	High Acuity Wide-field K-band Imager
NIR	Near InfraRed
OB	Observing Block
P2PP	Phase II Proposal Preparation
PSF	Point Spread Function
QC	Quality Control
RTC	Real Time Computer
RTD	Real Time Display
SM	Service Mode
TIO	Telescope and Instrument Operator
USD	User Support Department
VLT	Very Large Telescope
VM	Visitor Mode

Part I

Observing with HAWK-I: from phase 1 to data reduction

2 PHASE 1: applying for observing time with HAWK-I

This section will help you to decide whether HAWK-I is the right instrument for your scientific projects, take you through a quick evaluation of the observing time needed, and guide you through the particularities of HAWK-I in the proposal form.

2.1 Is HAWK-I the right instrument for your project?

HAWK-I does only one thing, but does it well: direct imaging in the NIR (0.97 to 2.31 μm) over a large field (7.5' \times 7.5'). So far HAWK-I has been successfully used to study the properties of medium redshift galaxy clusters (see e.g. Lidman et al. 2008, A&A 489,981), outer solar system bodies (Snodgrass et al. 2010, A&A 511, 72), the very high redshift universe (Castellano et al. 2010, A&A 511, 20), and exo-planets (Gillone et al. 2009, A&A 506, 359). The recent implementation of Fast Photometry (see Appendix F) is probably going to boost more activity in the exo-planet field. If you are interested in doing stellar population studies, be aware that the present read-out mode does not allow to image field with bright stars in the Milky Way disk or bulge.

The basic characteristics (FoV, pixel scale, ...) can be found in the nutshell at the beginning of this document.

2.1.1 Field of View

The FoV of HAWK-I is defined by four Hawaii-2RG chips of 2048² pixels each (1 pixel corresponds to 0.106 arcsec on the sky). The detectors are separated by gaps of about 15 arcsec. Thus, the FoV looks like this:

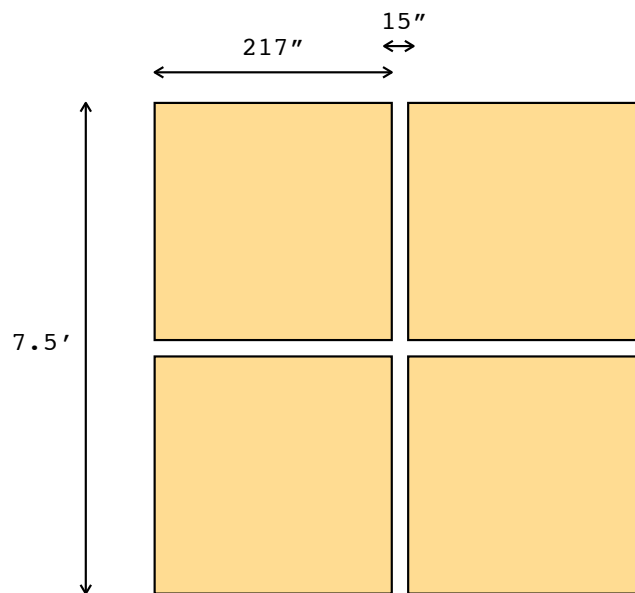

Note that it is very tempting to point *right onto* your favorite target and to loose it in the gap, since this is where the telescope points.

BEWARE of the gap between the detectors! And see the details in Appendix C.

2.1.2 Filters

HAWK-I is equipped with 10 filters: 4 broad band filters, and 6 narrow band filters. (see appendix A for detailed characteristics and the URL to download the filter curves in electronic form).

The broad-band filters are the classical NIR filters: Y,J,H,Ks. The particularity of HAWK-I is that the broad band filter set has been ordered together with the ones of VISTA. There are thus *identical* which allows easy cross-calibrations and comparisons.

The narrow band filters include 3 cosmological filters (for Ly α at z of 7.7 ($1.06\mu\text{m}$) and 8.7 ($1.19\mu\text{m}$), and H α at $z = 2.2$, i.e. $2.09\mu\text{m}$) as well as 3 stellar filters (CH $_4$, H $_2$, Br γ).

Can you bring your own filters? Possibly.

HAWK-I hosts large (105mm^2 , i.e. expensive) filters, and was designed to have an easy access to the filter wheel. However, to exchange filters the instrument needs to be warmed up which, usually, only happens once per year.

Thus, in exceptional cases, i.e. for very particular scientific program, user supplied filters can be installed in HAWK-I, within the operational constraints of the observatory. Please make sure to contact paranal@eso.org before buying your filters.

2.1.3 Limiting magnitudes

Limiting magnitudes are of course very much dependent on the observing conditions. The [exposure time calculator](#) (ETC) is reasonably well calibrated and we encourage you to use it. In order to give you a rough idea of the performance to be expected, we list here the limiting magnitudes (S/N=5 for a point source in 3600s integration on source) under average conditions (0.8" seeing, 1.2 airmass):

Filter	Limiting mag [Vega]	Limiting mag [AB]	Saturation limit (in 2 sec)*
J	23.9	24.8	10.0
H	22.5	23.9	10.3
K _s	22.3	24.2	9.2

*: assumed 0.8" seeing.

For more detailed exposure time calculation, in particular for narrow band filters, please use the [exposure time calculator](#).

Due to persistence effect of the detector, in service mode, no observation will be accepted for fields containing objects brighter than K_s=8.1 , H=9.1 & J=8.8 ; i.e. ~ 5 times the saturation level. This is really a generous lower limit, brighter objects will produce persistence, now more easily because of the larger minimum DIT (1.6762 secs). Please check carefully your fields during Phase II preparation.

2.1.4 Instrument's performance

We expect HAWK-I to be used for plain imaging, photometry and astrometry.

The image quality of HAWK-I is excellent across the entire field of view. Distortions are below 2% over the full 10' diagonal and the image quality has always been limited by the seeing (our best recorded images had FWHM below 2.2 pix, i.e. $<0.23''$ in the K_s band).

The photometric accuracy and homogeneity that we measured across one quadrant is $<5\%$ (as monitored on 2MASS calibration fields). We expect that with an even more careful illumination correction and flat-fielding about 3% absolute accuracy across the entire field will be achieved routinely when the calibration database is filled and stable.

Of course, differential photometry can be pushed to a higher accuracy. Note in particular, that given the HAWK-I field size, between 10 and 100 useful 2MASS stars (calibrated to 0.05 – 0.10 mag) are usually present in the field.

Finally, the relative astrometry across the entire field is auto-calibrated on a monthly basis (see HAWKI calibration plan), using a sample of globular clusters as references. The distortion map currently allows to recover relative position across the entire field with a precision of ~ 1 arcsec

A note of caution: as all current infrared arrays, the HAWK-I detectors suffer of persistence at the level of $10^{-3} - 10^{-4}$ (depending on how badly the pixels were saturated) that decays slowly over minutes (about 5min for the maximum tolerated saturation level in SM). This might leave artifacts reflecting the dither pattern around saturated stars.

2.2 Photometry with HAWK-I

As you will have noticed, acquiring a single star per night does not allow to carry out high precision photometry, but rather to monitor the instrument performance, and make a rough evaluation of the quality of the night.

2.2.1 Two ways to get reasonable photometry

If good photometry is your goal, you should go for one of the following options.

- **Ask for special calibrations!** Take into account as early as phase 1 (i.e. in your proposal) the fact that you want to observe more and other standard fields than the ones foreseen in the calibration plan.

In your README file you can then explain that you want your specified standard field observed e.g. before and after your science OB.

You can also specify that you want illumination maps for your filters close in time to your observations, and/or specify as special calibrations your own illumination maps.

- If a photometric calibration to ~ 0.05 – 0.1 magnitude is enough for your program, consider that the HAWK-I field is large and that (by experience) you will have 10–100 stars from the 2MASS catalog in your field.

These are typically cataloged with a photometry good to < 0.1 mag and would allow to determine the zero point on your image to ~ 0.05 mag, using these "local secondary standards". Extinction coefficients would automatically be taken into account. They are measured on a monthly basis. Besides, we remind that colour terms for HAWK-I are small, $\sim 0.1 \times (J-K)$.

Check with Skycat (or Gaia) ahead of time whether good (non-saturated!) 2MASS stars are present in your science field.

Skycat is available under <http://archive.eso.org/skycat/>

Gaia is part of the starlink project: <http://starlink.jach.hawaii.edu/>

2.2.2 Consider the 2MASS calibration fields

The 2MASS mission used a number of calibration fields for the survey. Details are given at http://www.ipac.caltech.edu/2mass/releases/allsky/doc/seca4_1.html

In particular the sect.III, 2 http://www.ipac.caltech.edu/2mass/releases/allsky/doc/sec3_2d.html provides a list of fields (touch-stone fields) that **you could use** as photometric fields in order to calibrate your observations.

2.2.3 HAWK-I extinction coefficients

We measured HAWK-I extinction coefficient for the broad-band filters as a result of a year monitoring. The results are:

$$J = 0.043 \pm 0.005$$

$$H = 0.031 \pm 0.005$$

$$K_s = 0.068 \pm 0.009$$

$$Y = 0.021 \pm 0.007$$

We plan to keep monitoring these coefficients on a monthly basis, according to the calibration plan.

2.3 The Exposure Time Calculator

The HAWK-I ETC can be found at:

<http://www.eso.org/observing/etc>

it returns a good estimation of the integration time (on source!) needed in order to achieve a given S/N, as a function of atmospheric conditions.

A few words about various *input variables* that might not be quite standard (also read the online help provided on the ETC page):

- the parameters to be provided for the input target are standard. The input magnitude can be specified for a point source, for an extended source (in which case we compute an integration over the surface defined by the input diameter), or as surface brightness (in which case we compute values per pixel e.g. 106×106 mas).
- Results are given as exposure time to achieve a given S/N or as S/N achieved in a given exposure time. In both cases, you are requested to input a typical DIT, which for broad band filters will be short (10 to 30s) but for narrow band filters could be long exposures between 60 and 300s before being sky background limited.
- Do not hesitate to make use of the many graphical outputs. In particular for checking your target line (and the sky lines) in the NB filters...

The *screen output from the ETC* will include the input parameters together with the calculated performance estimates. Here some additional notes about the ETC output values:

- The integration time is given on source: depending on your technique to obtain sky measurements (jitter? or offsets?), and accounting for overheads, the total observing time will be much larger.
- The S/N is computed over various areas as a function of the source geometry (point source, extended source, surface brightness). Check carefully what was done in your case.

Most of the other ETC parameters should be self-explaining and/or well explained in the online help of the ETC.

2.4 Proposal Form

HAWK-I allows only 1 set-up: direct Imaging.

Please indicate which filters (in particular narrow-band filters) you intend to use. This will allow us to optimize their calibration during the semester.

```
%\INSconfig\{HAWK-I}\Imaging\{provide HERE list of filters(s) (Y,J,H,K,NB1060,NB1190,NB2090,H2,BrG,CH4)}
```

2.5 Overheads and Calibration Plan

When applying for HAWK-I, do not forget to take into account all the overheads when computing the required time.

- Make sure that you compute the exposure time including on sky time (not only on source) if your observing strategy requires it.
- Verify in the **call for proposal** that you have taken into account all listed overheads; which can also be found in Sect. 4.5. To do so you can either refer to Sect. 4.5 or simulate the detailed breakdown of your program in terms of its constituent Observing Blocks (OBs) using the P2PP tutorial manual account (see Sect. 1.4 of the P2PP User Manual available at). The Execution Time Report option offered by P2PP provides an accurate estimate of the time needed for the execution of each OB, including all necessary overheads.
- Check whether you need any special calibration: have a look at the calibration plan in Sect. D – this is what the observatory will give you as default. You might need more, and we will be happy to provide you with more calibrations, if you tell us which. Note however that night calibrations should be accounted for by the user. Any additional calibration you might need should be mentioned in the phase 1 proposal and the corresponding (night) time to execute them must be included in the total time requested.

3 PHASE 2: Preparing your HAWK-I observations

This sections provides a preliminary guide for the observation preparation for HAWK-I in phase 2, both for Service mode (SM) or Visitor mode (VM).

We assume that you are familiar with the existing generic guidelines which can be found at:

- <http://www.eso.org/observing/observing.html> Proposal preparation
- <http://www.eso.org/observing/phase2/SMGuidelines.html> Service mode informations
- http://www.eso.org/paranal/sciops/VA_GeneralInfo.html VM informations

We know that they are not super-thrilling, but a quick browse over them might save you some time during phase 2.

3.1 HAWK-I specifics to templates, OBs, and p2pp

HAWK-I follows very closely the philosophy set by the ISAAC (short wavelength) and NACO imaging templates.

3.1.1 p2pp

Using p2pp to prepare HAWK-I observations does not require any special functions (no file has to be attached except for the finding chart, all other entries are typed).

3.1.2 Observing Blocks – OBs

As an experienced ESO user, it will come as no surprise to you that any HAWK-I science OB should contain one acquisition template, followed by a number of science templates.

If this **did** surprise you, you may need to get [back to the basics](#).

3.1.3 Templates

The HAWK-I templates are described in detail in the template reference guide available through the [instrument web pages](#).

A brief overview is given below. If you are familiar with the ISAAC SW imaging or NACO imaging templates, these will look very familiar to you and cover essentially the same functionalities.

The acquisition and science templates are listed in Table 1.

Two forms of acquisition exist: a simple preset (when a crude accuracy of a couple of arcsec is enough), and the possibility to intearctively place the target in a given position on the detector.

The science templates provide four forms of obtaining sky images: small jitter patterns for uncrowded fields; random sky-offsets for extended or crowded fields when the off-position needs to be acquired far from the target field; fixed sky-offsets when random sky-offsets are not suited; and finally the possibility to define an arbitrary offset pattern, when the standard strategies are not suited.

For Rapid Response Mode we offer two acquisition templates. They are exactly the same as the normal acquisition template, but with the string RRM appended to the name.

Table 1: Acquisition and science HAWK-I templates

acquisition templates	functionality	comment
HAWKI_img_acq_Preset	Simple telescope preset	recommended
HAWKI_img_acq_MoveToPixel	Interactive target acquisition	
HAWKI_img_acq_PresetRRM	Simple telescope preset for RRM	offered starting P82
HAWKI_img_acq_MoveToPixelRRM	Interactive target acquisition for RRM	offered starting P82
HAWKI_img_acq_FastPhot	Acquisition for windowed mode	
science templates		
HAWKI_img_obs_AutoJitter	imaging with jitter (no offsets)	recommended for low-density fields
HAWKI_img_obs_AutoJitterOffset	imaging with jitter and random sky offsets	recommended for extended objects
HAWKI_img_obs_FixedSkyOffset	imaging with jitter and fixed sky offsets	when random sky is not suited
HAWKI_img_obs_GenericOffset	imaging with user defined offsets	
HAWKI_img_obs_FastPhot	imaging with fast read out and windowing	

The calibration and technical templates are listed in Table 2.

The only calibration template accessible to the SM user is the one to take standard stars.

The calibration templates are foreseen to acquire darks, flat-fields and simple standard star observations to calibrate the zero point.

The technical templates are used for the periodical characterization of the instrument. The illumination frames are used to determine the variation of the zero point as a function of detector position. The astrometry and flexure templates are needed to compute the distortion map, the plate scale and relative positions of the detectors and to quantify possible flexures. Three further templates are used to characterize the detector, to determine the best telescope focus and to measure the reproducibility of the filter wheel positioning.

Table 2: Calibration and technical HAWK-I templates

calibration templates	functionality	comment
HAWKI_img_cal_Darks	series of darks	
HAWKI_img_acq_TwPreset	acquisition for flat-field	
HAWKI_img_cal_TwFlats	imaging twilight flat-field	
HAWKI_img_cal_SkyFlats	imaging sky flat-field	
HAWKI_img_cal_StandardStar	imaging of standard field	available to the SM user
technical templates		
HAWKI_img_tec_IlluFrame	imaging of illumination field	
HAWKI_img_tec_Astrometry	imaging of astrometric field	
HAWKI_img_tec_Flexure	measuring instrument flexure/center of rotation	
HAWKI_img_tec_DetLin	detector test/monitoring	
HAWKI_img_tec_Focus	telescope focus determination	
HAWKI_img_tec_FilterWheel	filter wheel positioning accuracy	

3.2 Finding Charts and README Files

In addition to the general instructions on finding charts (FC) and README files that are available at:

<http://www.eso.org/observing/p2pp>

the following HAWK-I specifics are recommended:

- The FoV of all FCs must be 10' by 10' in size, with a clear indication of the field orientation.

- Ideally, the FC should show the field in the NIR, or at least in the red, and the wavelength of the image must be specified in the FC and the README file.
- The (IR) magnitude of the brightest star in the field must be specified in the P2PP comment field of the OB.

4 Observing (Strategies) with HAWK-I

4.1 Overview

As with all other ESO instruments, users prepare their observations with the p2pp software. Acquisitions, observations and calibrations are coded via templates and OBs. OBs contain all the information necessary for the execution of an observing sequence.

At the telescope, OBs are executed by the instrument operator. HAWK-I and the telescope are setup according to the contents of the OB.

The HAWK-I Real Time Display (RTD) is used to view the raw frames. During acquisition sequences, the RTD can be used as well as for the interactive centering of the targets in the field.

Calibrations including DARKs, skyflats, photometric standard stars, illumination maps etc are acquired by the Observatory staff according to the calibration plan and monitored by the Quality Control group of ESO Garching.

4.2 Visitor Mode Operations

Information/policy on the Visitor Mode operations at the VLT are described at:

http://www.eso.org/paranal/sciops/VA_GeneralInfo.html

Visitors should be aware that about 30 minutes/night (of night time!) may be taken off their time, in order to perform the HAWK-I calibrations according to the calibration plan. In Visitor mode is also possible to observe bright objects using BADA0, say switching active optics off. **Telescope and/or instrument defocussing are however not permitted.**

4.3 The influence of the Moon

Moonlight does not noticeably increase the background in the NIR, so there is no need to request dark or gray time.

However, it is recommended not to observe targets closer than 30 deg to the Moon to avoid problems linked to the telescope guiding/active optics system. The effect is difficult to predict and to quantify as it depends on too many parameters. Just changing the guide star often solves the problem.

Visitors should check their target positions with respect to the Moon at the time of their scheduled observations (e.g. with the tools available at <http://www.eso.org/observing/support.html>). Backup targets are recommended whenever possible, and you are encouraged to contact ESO in case of severe conflict (i.e. when the distance to the Moon is smaller than 30 deg).

4.4 Orientation, offset conventions and definitions

HAWK-I follows the standard astronomical offset conventions and definitions: North is up and East to the left.

All offsets are given as telescope offsets (i.e. your target moves exactly the other way) in arcseconds. The reference system can be chosen to be the sky (offsets 1 and 2 refer to offsets

in Alpha and Delta respectively, independently of the instrument orientation on the sky) or the Detector (offsets 1 and 2 refer to the detector +X and +Y axis, respectively).

For jitter pattern and small offset, it is more intuitive to *use the detector coordinates* as you probably want to move the target on the detector, or place it on a different quadrant (in which case, do not forget the 15" gap!).

The sky reference system is probably only useful when a fixed sky frame needs to be acquired with respect to the pointing.

For a position angle of 0, the reconstructed image on the RTD will show North up (+Y) and East left (-X). The positive position angle is defined from North to East.

Note that **the templates use always offsets relative to the previous pointing**; not relative to the *original* position (i.e. each offset is measured with respect to the *actual pointing*).

For example, if you want to place a target in a series of four offsets in the center of each quadrant: point to the star, then perform the offsets (-115,-115) [telescope moves to the lower left, star appears in the upper right, i.e. in Q3]; (230, 0); (0, 230); (-230, 0).

Note that HAWK-I offers during execution a display that shows, at the start of a template, all the offsets to be performed (see below). It provides a quick visual check whether your pattern looks as expected (see Fig. 1):

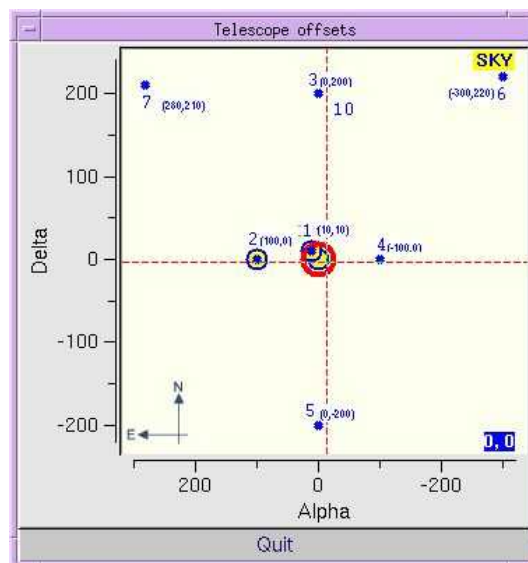

Figure 1: Pop-up window at the start of an example template: it provides a quick check of your offset pattern

In the above example (Fig. 1), 7 offsets are requested, and the way they are performed is shown in Fig. 2. The sequence of offset will be: (10,10), (90,-10), (-100,200), (100,-200), (-300,420) and (580,-10).

4.5 Instrument and telescope overheads

The telescope and instrument overheads are summarized below.

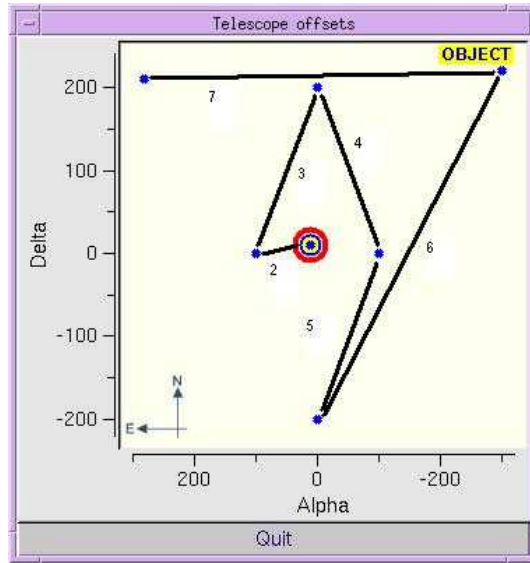

Figure 2: Offset execution along the template.

Hardware Item	Action	Time (minutes)
Paranal telescopes	Preset	6
HAWK-I	Acquisition	(*)
HAWK-I	Initial instrument setup (for ACQ only)	1
HAWK-I	Telescope Offset (small)	0.15
HAWK-I	Telescope Offset (large >90")	2.0
HAWK-I	Readout (per DIT)	0.03
HAWK-I	After-exposure (per exposure)	0.13
HAWK-I	Filter change	0.35

(*) The instrument set-up is usually absorbed in the telescope preset for a simple preset. In the case of 'MoveToPixel', the exact integration time is dependent on the number of images one needs to take (at least 2) and of course the corresponding integration time. For 3 images of Detector Integration Time (DIT) =2 (NDIT=1), the overhead is 1.5min.

4.6 Recommended DIT/NDIT and Object–Sky pattern

For DITs longer than 120sec, the SM user has to use one of the following DIT: 150, 180, 240, 300, 600 and 900sec.

Table 3 lists the contribution of the sky background for a given filter and DIT. Please note that these values are indicative and can change due to sky variability especially for H band, whose flux for a given DIT can fluctuate by a factor of 2, due to variations of the atmospheric OH lines. This effect also impacts the Y, J & CH4 filters. The Moon has an effect on the sky background, especially for the NB1060 and NB1190 filters. Similarly the variation of the outside temperature impacts the sky contribution for the K_s, BrG, H2 and NB2090 filters.

Due to the sky variations and in order to allow for proper sky subtraction, we recommend to offset at least every 2 minutes. Please be reminded that the minimum time at a position before an offset is about 1 minute.

Table 3: Sky background contribution & Useful integration times

Filter	Contribution from sky (electrons/sec)	RON limitation ~DIT (sec)	linearity limit ~DIT (sec)	Recommended DIT (sec)
Broad band filters				
K _s	1600	< 1	30	10
H	2900	< 1	20	10
J	350	1.15	140	10
Y	130	3	400	30
Narrow band filters				
CH4	1200	< 1	40	10
NB2090	60	7	900	60
NB1190	3.6	110	14000	300
NB1060	3.4	120	14000	300
H2	140	17	400	30
BrG	180	15	300	30

The figure 3 shows the quality of the sky subtraction as a function of pupil angle and time from the first frame. A sequence of frames in the K_s band was obtained when the target was near the zenith, and the pupil was rotating by 2.45 degrees/minute. Being the VLT an alt-azimuth telescope the image rotates with respect to the pupil. This is noticed as a rotation of the diffraction spikes seeing around bright stars. The sky-subtraction error is larger when the pupil rotation angle between the two images is largest.

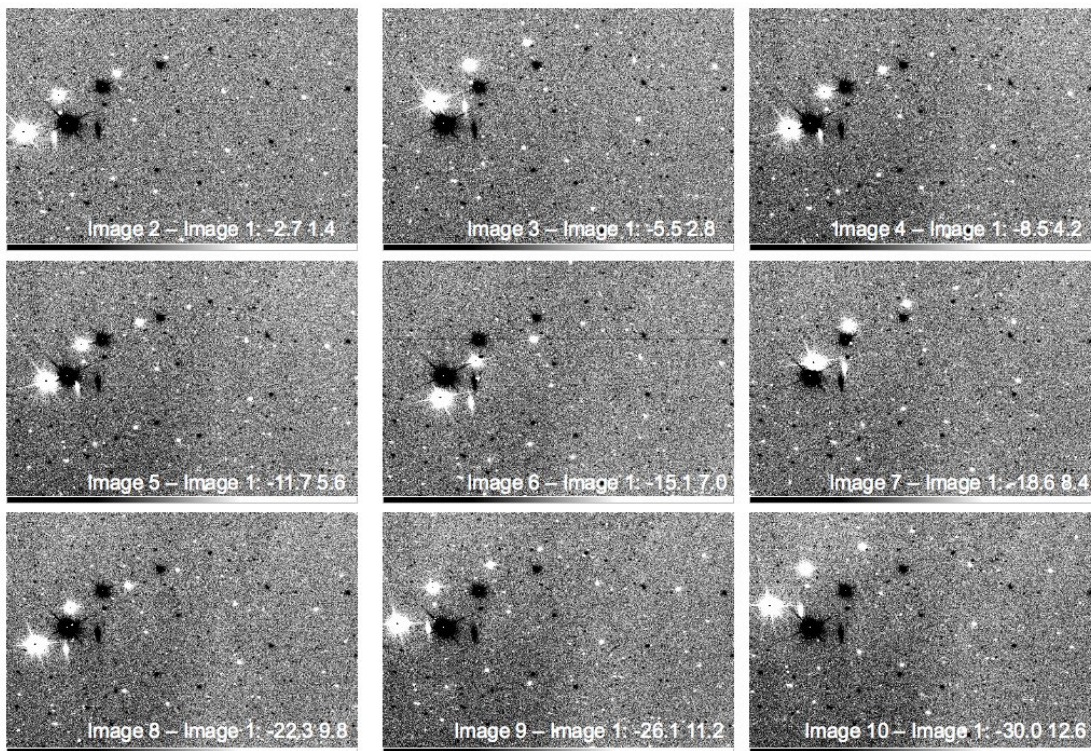

Figure 3: The annotation indicate the difference in pupil angle between the two frames being subtracted, and the difference in start time between the two exposures.

Part II

Reference Material

A The HAWK-I filters

The 10 filters in HAWK-I are listed in Table 4.

The filter curves as ascii tables can be retrieved from the [hawki instrument page](#).

Note in particular that the Y band filter leaks and transmits 0.015% of the light between 2300 and 2500 nm. All other filters have no leaks (at the $<0.01\%$ level).

Table 4: HAWK-I filter summary

Filter name	central wavelength [nm]	cut-on (50%) [nm]	cut-off (50%) [nm]	width [nm]	transmission [%]	comments
Y	1021	970	1071	101	92%	LEAKS! 0.015% at 2300–2500 nm
J	1258	1181	1335	154	88%	
H	1620	1476	1765	289	95%	
K _s	2146	1984	2308	324	82%	
CH ₄	1575	1519	1631	112	90%	
Br γ	2165	2150	2181	30	77%	
H ₂	2124	2109	2139	30	80%	
NB1060	1061	1057	1066	9	70%	
NB1190	1186	1180	1192	12	75%	
NB2090	2095	2085	2105	20	81%	

Optical ghosts (out of focus images showing the M2 and telescope's spiders) have been rarely found only with the NB1060 (Ly α at $z = 7.7$) & NB1190 (Ly α at $z = 8.7$) filters. As illustrated in Fig. 4, the ghost images are 153 pixels in diameter and offset from the central star in the same direction; however the latter varies with each quadrant and is not symmetric to the centre of the mosaic. The total integrated intensities of the ghosts are in both cases $\sim 2\%$ but their surface brightnesses are a factor 10^{-4} of the peak brightness in the stellar PSF.

The figure 5 summarizes the HAWK-I filters graphically.

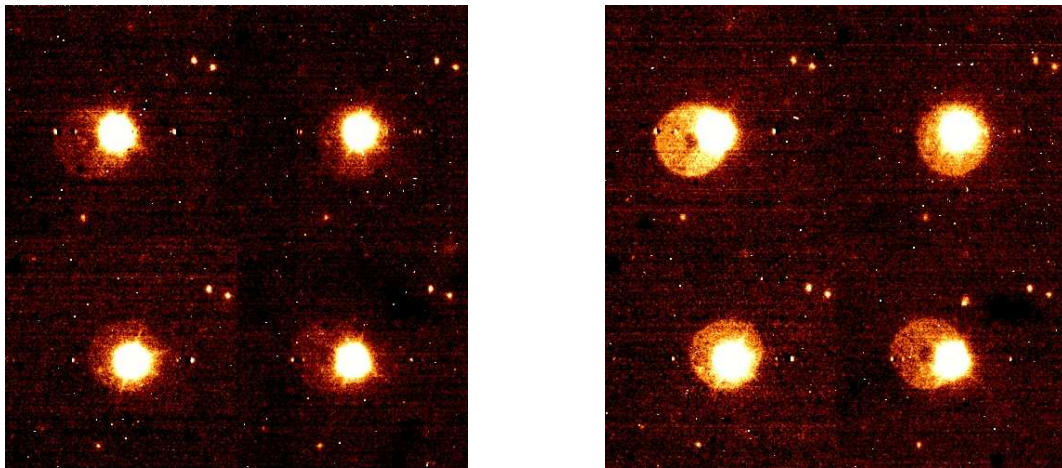

Figure 4: Smoothed enhanced images of the optical ghosts visible in the four quadrants for the NB1060 (left) & NB1190 (right) filters

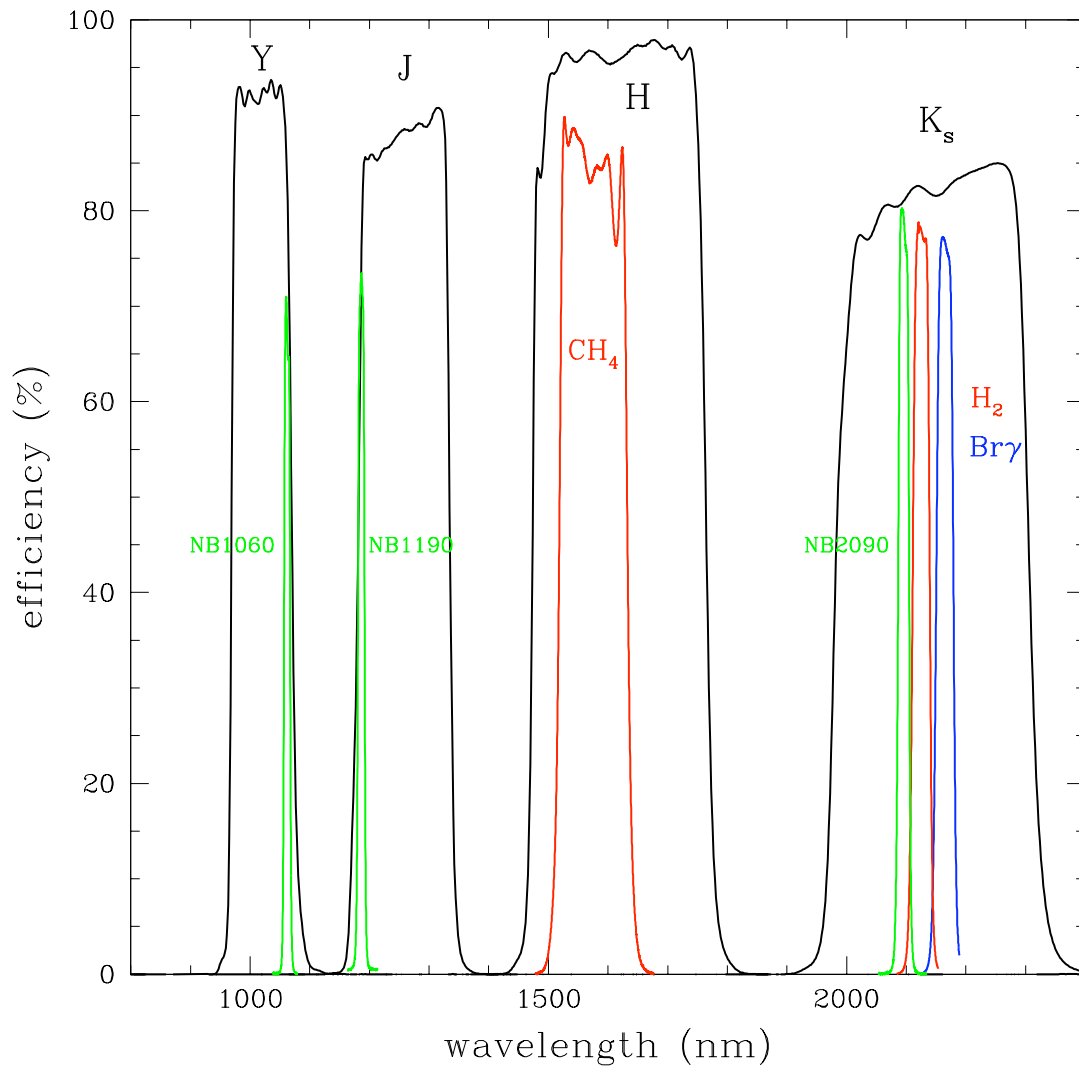
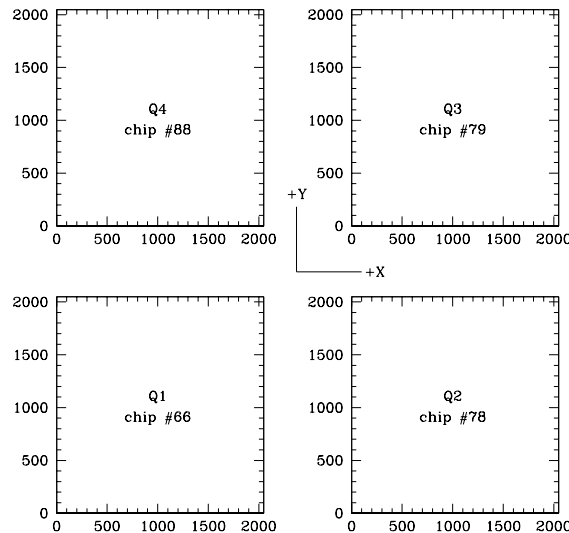

Figure 5: HAWK-I Filters. Black: broad-band filters Y, J, H, K_s , Green: cosmological filters NB1060, NB1190, NB2090; Red: CH_4 , H_2 ; Blue: $Br\gamma$

B The HAWK-I detectors

The naming convention for the four detectors is the following:



Note that quadrant 1,2,3,4 are usually, **but not necessarily**, stored in extensions 1,2,4,3 of the HAWK-I FITS file. Indeed, FITS convention forbids to identify extensions by their location in the file. Instead, look for the FITS keyword EXTNAME in each extension and verify that you are handling the quadrant that you expect (eg. EXTNAME = 'CHIP1.INT1').

The characteristics of the four detectors are listed below:

Detector Parameter	Q1	Q2	Q3	Q4
Detector Chip #	66	78	79	88
Operating Temperature	75K, controlled to 1mK			
Gain [e ⁻ /ADU]	1.705	1.870	1.735	2.110
Dark current (at 75 K) [e ⁻ /s]	between 0.10 and 0.15			
Minimum DIT	1.6762 s			
Read noise ¹ (NDR)	~ 5 to 12 e ⁻			
Linear range (1%)	60.000 e ⁻ (~ 30.000 ADUs)			
Saturation level	between 40.000 and 50.000 ADUs			
DET.SATLEVEL	25000			

¹ The noise in Non-Destructive Read (NDR) depends on the DIT: the detector is read continuously every ~1.6762s, i.e the longer the DIT, the more reads are possible and the lower the RON. For the minimum DIT (1.6762s), the RON is ~12e⁻; for DIT=10s, the RON is ~8e⁻ and for DIT>15s, the RON remains stable at ~5 e⁻.

Figure 6 represents the quantum efficiency curve for each of the detectors.

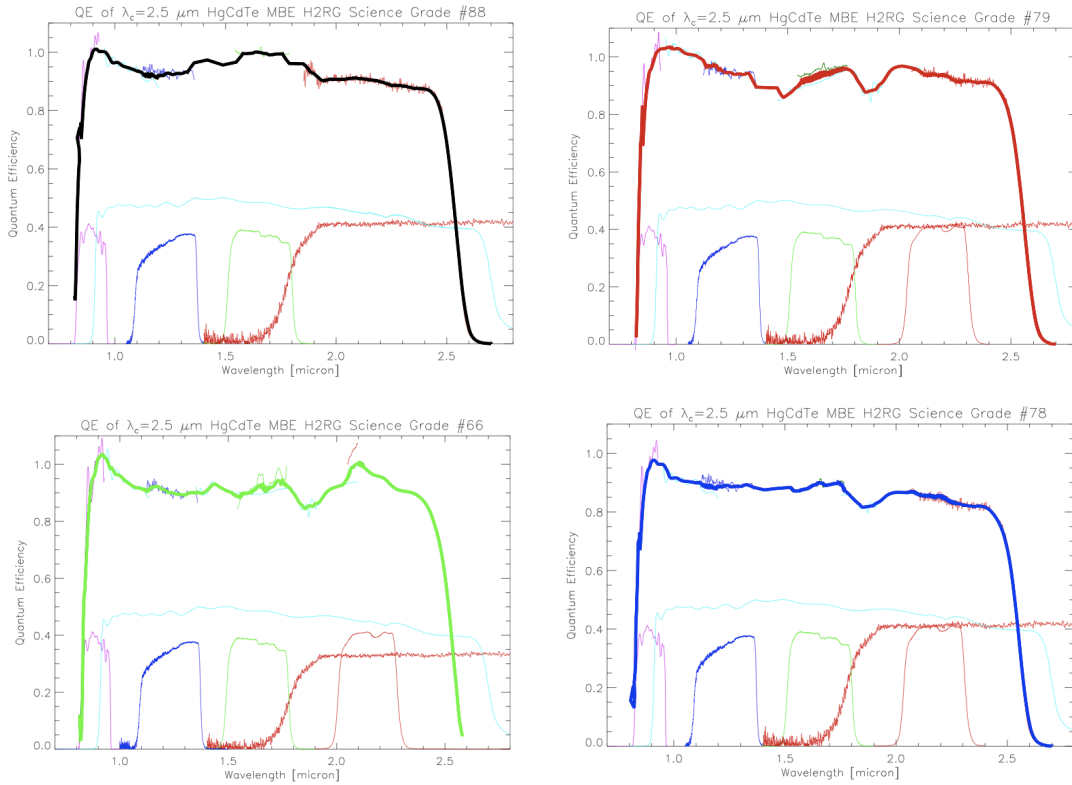

Figure 6: Quantum efficiency of the HAWK-I detectors

B.1 Threshold-limited integration

The normal mode of operation of the HAWK-I detectors defined a threshold by setting the keyword `DET.SATLEVEL`. All pixels which have absolute ADU values below this threshold are processed normally. Once pixels illuminated by a bright star have absolute ADU values above the threshold, the values are no longer used to calculate the slope of the regressional fit. For these pixels only non-destructive readouts having values below the threshold are taken into account. The pixel values written into the FITS file is the value **extrapolated** to the integration time DIT and is calculated from the slope using only readouts below the threshold. The pixels that have been extrapolated can be identified because their values are above `DET.SATLEVEL`.

B.2 Detectors' structures and features

We present some of HAWK-I's detector features in two examples.

Figure 7 is a typical long (> 60s) exposure. Some features have been highlighted:

- 1: some black features on chip 66 & 79. For both of them, when light falls directly on these spots some diffraction structures can be seen, as shown in the corresponding quadrants in Fig. 7.
- 2: On the left (chip #88) there is an artefact on the detector's surface layer. On the right (chip #79), these are sort of doughnut shaped features. More of these can be seen in Fig. 8 on chip #88. Both features are stable and removed completely by simple data reduction (no extra step needed).

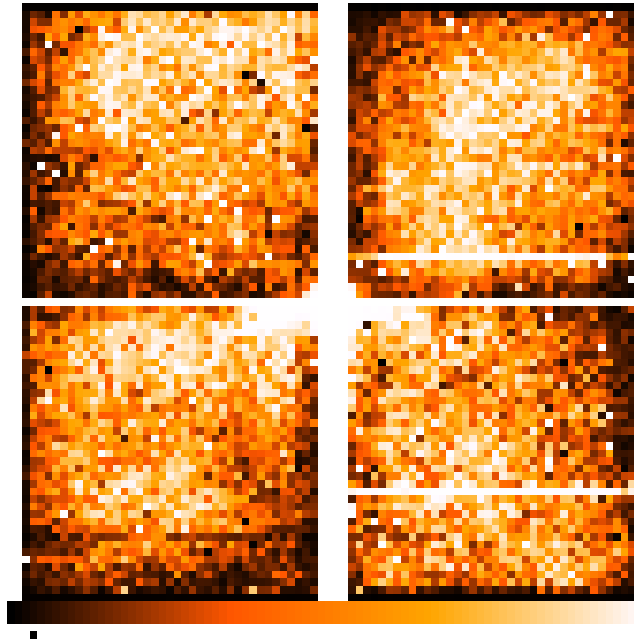

Figure 7: Typical raw HAWK-I dark frame (DIT=300sec)

- 3: Detector glow, which is visible for long DITs, but is removed by e.g. sky subtraction
- 4: The darker area visible in Fig 8 corresponds to the shadow of the baffling between the detectors.
- 5: Emitting structure, whose intensity grows with the integration time. It is however fully removed by classical data reduction.
- 6: Q2 chip#78 suffers from radioactive effects (see Fig. 10 below)
- 7: Q4 chip#88 dark median has been found to be larger than the other detectors, and to increase with NDIT (see Fig. 9). Thanks to Sylvain Guieu for detecting this.

B.3 Detectors' relative sensitivity

We undertook a program to assess the relative sensitivities of the four HAWK-I chips, using observations of the high galactic latitude field around the $z=2.7$ quasar B0002-422 at RA 00:04:45, Dec. -41:56:41 taken during technical time. The observations consist of four sets of 11×300 sec AutoJitter sequences in the NB1060 filter. The four sequences are rotated by 90 degrees in order that a given position on the sky is observed by each of the four chips of the HAWK-I detector. The jitter sequences are reduced following the standard two-pass background subtraction workflow described in the HAWK-I pipeline manual. Objects have been detected with the SExtractor software (courtesy of Gabriel Brammer), including a $0.9''$ gaussian convolution kernel roughly matched to the average seeing measured from the reduced images. Simple aperture photometry is measured within $1.8''$ diameter apertures.

The resulting number counts as a function of aperture magnitude observed by each chip are shown in Fig. 11. As expected, the coaddition of the four jitter sequences reaches a factor of 2 (0.8 mag) deeper than do the individual sequences. The limiting magnitudes, here taken to be the magnitude

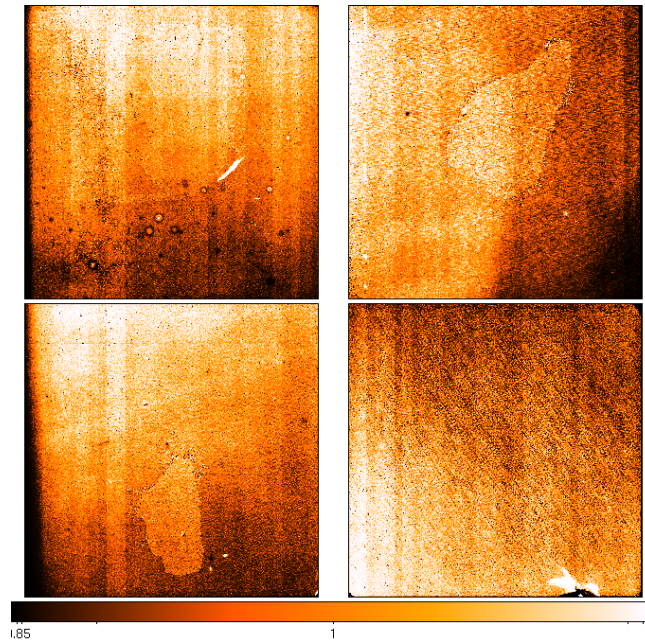

Figure 8: Typical raw HAWK-I twilight flat field (Y Band)

where the number counts begin to decrease sharply and a proxy for the chip sensitivities, are remarkably similar between the four chips. We conclude that any sensitivity variations between the chips are within the 10%. While they do not appear to affect the overall sensitivity, the image artifacts on CHIP2 caused by radioactivity events (see Fig. 10) do result in an elevated number of spurious detections (dashed lines in Fig. 11) at faint magnitudes, reaching 20% at the limiting magnitude for this chip. The number of spurious detections in the other chips is negligible (see Fig 7). This rate of spurious detections on CHIP2 should be considered as a conservative upper limit, as it could likely be decreased by more careful optimization of the object detection parameters.

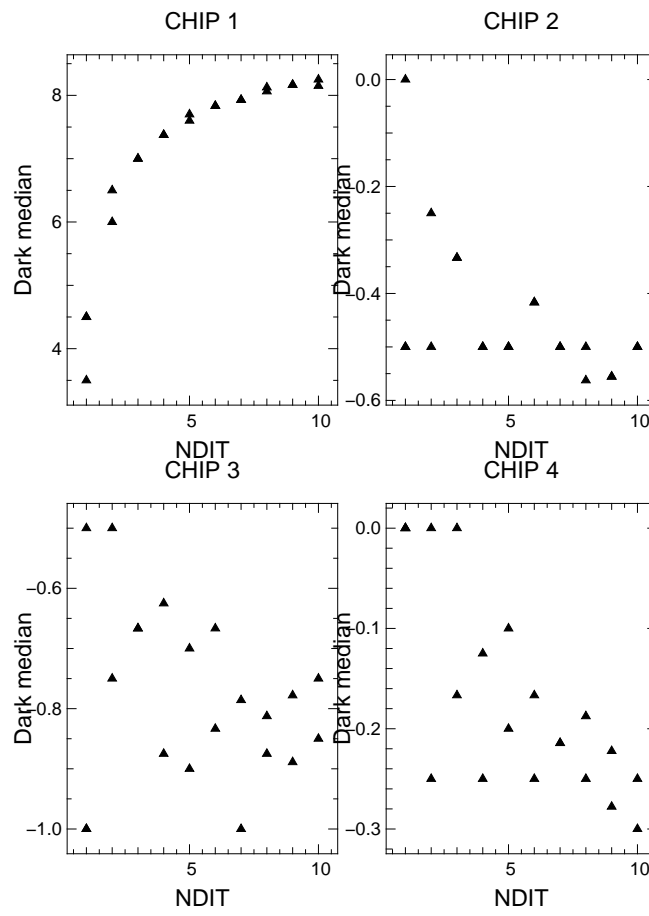

Figure 9: Trend of dark with NDIT in the 4 detectors.

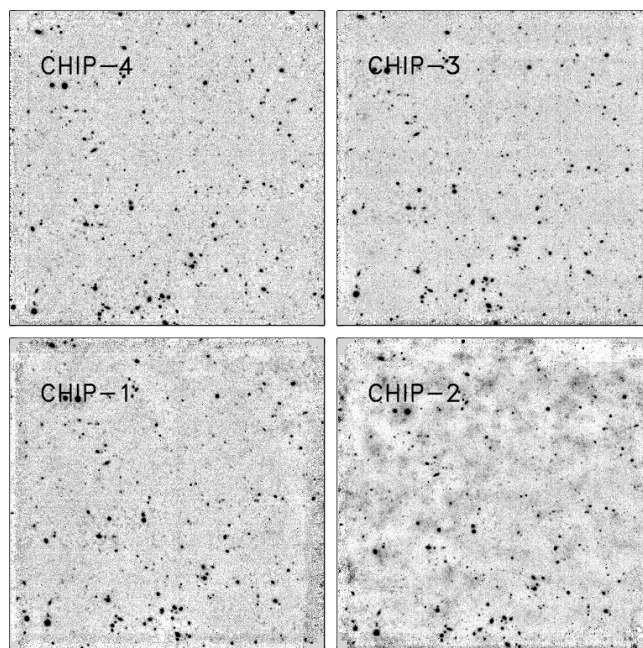

Figure 10: The field around the $z=2.7$ quasar B0002-422 as seen in the 4 HAWK-I quadrants.

Figure 11: Number counts as a function of aperture magnitude for the four HAWK-I chips. The magnitudes as plotted adopt an arbitrary zeropoint of 25 plus the relative zeropoint offsets as monitored for the J filter (-0.14, +0.03, -0.23 mag for chips 2–4, relative to chip 1). The limiting magnitudes, i.e. the location of the turnover in the number counts, of the four chips are essentially identical within the measurement precision of this exercise ($\leq 10\%$). Also shown are the number counts for a deep coadded stack of the four rotated and aligned jitter sequences. We use this deep image to assess the number of spurious sources detected on each chip: objects matched from the single chip image to the deeper image are considered to be real, while objects that only appear on the single-chip images are considered spurious. The number of spurious detections is negligible for chips 1, 3, and 4, though for chip 2 it reaches 20% around the limiting magnitude.

C The HAWK-I Field-of-View

C.1 Relative position of the four quadrants

The four quadrants are very well aligned with respect to each other. Yet, small misalignments exist. They are sketched below:

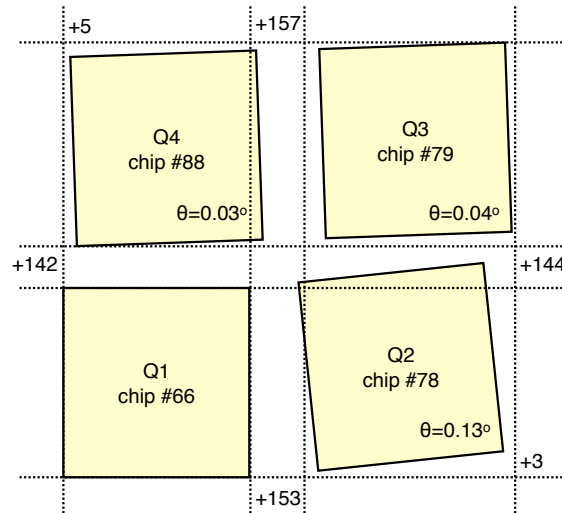

Quadrants 2,3,4 are tilted with respect to quadrant 1 by 0.13, 0.04, 0.03 degrees, respectively. Accordingly, the size of the gaps changes along the quadrant edges.

The default orientation (PA=0 deg) is North along the +Y axis, East along the -X axis, for quadrant #1.

For reference purposes, we use the (partly arbitrarily) common meta system:

Quadrant	offset in X (pix)	offset in Y (pix)
Q1	0	0
Q2	2048 + 153	0 + 3
Q3	2048 + 157	2048 + 144
Q4	0 + 5	2048 + 142

It is valid in its crude form to within a few pixels. The distortion corrections for a proper astrometry will be added to all image headers.

Distortions (including the obvious rotation component) will be defined with respect to the above system. First qualitative evaluations with respect to HST/ACS astrometric calibration fields recovered the relative positions of objects to about 5 mas once the distortion model was applied (a precision that should satisfy most purposes).

C.1.1 Center of Rotation and Centre of Pointing

The center of rotation of the instrument **is not exactly the centre of the detector array.**

In the standard orientation (North is +Y, East is -X) the center of the detector will be located ~0.4" East and ~0.4" South of the telescope pointing.

The common reference point for all four quadrants, taken as the centre of the telescope pointing and centre of rotation, has the following pixel coordinates (to ± 0.5 pix) in the respective quadrant reference system:

Quadrant	CRPIX1	CRPIX2
Q1	2163	2164
Q2	-37.5	2161.5
Q3	-42	-28
Q4	2158	-25.5

The CRVAL1 and CRVAL2 have the on-sky coordinates of the telescope pointing (FITS keywords TEL.TARG.ALPHA , TEL.TARG.DELTA) in all quadrants.

C.2 Vignetting of the field-of-view

The Hawaii2RG detectors have 4 reference columns/rows around each device which are not sensitive to light. In addition, due to necessary baffling in the all-reflective optical design of HAWK-I, some vignetting at the edges of the field has turned out to be inevitable due to positioning tolerances of the light baffles. The measured vignetting during commissioning on the sky is summarised in the following table:

Edge	No of columns or rows vignettted > 10%	Maximum vignetting
+Y	1	14%
-Y	8	54%
-X	7	36%
+X	2	15%

The last column represents the maximum extinction of a vignettted pixel, i.e. the percentage of light absorbed in the pixel row or column, with respect to the mean of the field.

Note : although the +Y edge vignetting is small in amplitude, it extends to around 40 pixels at < 10%.

D The HAWK-I calibration plan

D.1 Do you need special calibrations?

The calibration plan defines the default calibrations obtained and archived for you by your friendly Paranal Science Operations team.

The calibration plan is what you can rely on without asking for any special calibrations. However, these are indeed the only calibration that you can rely on without asking for special calibrations!!

Thus, we strongly advise all the users to carefully think whether they will need additional calibrations and if so, to request them right in phase 1.

For example: is flat-fielding very critical for your program, i.e. should we acquire more flats (e.g. in your narrow band filters)? Would you like to achieve a photometry better than a few percent, i.e. do you need photometric standards observe right before/after your science frames? Is the homogeneity of the photometry critical for your program - i.e. should you ask for illumination frames close to your observations? Is the astrometry critical, i.e. should we acquire a full set of distortion and flexure maps around your run?

We would be more than happy to do all that for you *if you tell us so* ! (i.e. if you mention it in phase 1 when submitting your proposal).

D.2 The HAWK-I standard calibrations in a nutshell

Here is what we do, if we do not hear from you:

HAWK-I – Calibration Plan			
Calibration	number	frequency	comments / purpose
Darks	10 exp. / DIT	daily	for $\text{DIT} \times \text{NDIT} \leq 120$
Darks	5 exp. / DIT	daily	for $\text{DIT} \times \text{NDIT} > 120$
Twilight Flat-fields	1 set / filter	daily	broad-band filters (best effort basis)
	1 set / filter	as needed	for narrow-band filters
Zero points	1 set / (broad-band) filter	daily	UKIRT/MKO or Persson std
Colour terms	1 set	monthly	broad-band filters only (best effort basis)
Extinction coefficients	1 set	monthly	broad-band filters only (best effort basis)
Detector characteristics	1 set	monthly	RON, dark current, linearity, ...

Please do not hesitate to contact us (usd-help@eso.org) if you have any questions!

D.3 Quality Control

All calibrations taken within the context of the calibration plan are pipeline-processed and quality-controlled by the Quality Control group at ESO Garching. Appropriate master calibrations, and the raw data they are derived from, for reducing the science data are included in each Service Mode data package along with the raw science data and the science pipeline products. More information about the HAWK-I quality control can be found under http://www.eso.org/qc/index_hawki.html.

The time evolution of the most important instrument parameters like DARK current, detector characteristics, photometric zero-points and others can be followed via the continuously updated trending plots available on the HAWK-I QC webpages.

E The HAWK-I pipeline

We refer to the pipeline manual for a full description on the HAWK-I pipeline. This section provides only a very brief overview of what to expect from the pipeline.

The pipeline full documentation is available at <http://www.eso.org/sci/data-processing/software/pipeline>

The planned data reduction recipes included in this delivery will be:

- `hawki_img_dark`: The dark recipe produces master dark and bad pixel map.
- `hawki_img_flat`: The flat-field recipe produces a master flat, a bad pixel map, a statistics table, the fit error image.
- `hawki_img_zpoint`: This recipe provides the zero points for the UKIRT selected standards.
- `hawki_img_detlin`: This recipe determines the detector linearity polynomial coefficients computation as well as the error on the fit.
- `hawki_img_illum`: The illumination map of the detectors is obtained by observing a bright photometric standard consecutively at all predefined positions over a grid.
- `hawki_img_jitter`: All science data resulting from the jitter and generic offset templates. The four quadrants are combined separately. The four combined products are eventually stitched together. The online reduction pipeline, working on Paranal, will not provide this stitched image if $\min(\text{offset}) < -1500$ or $\max(\text{offset}) > 1500$.

Besides, utilities will be provided to make it easier for the users to reduce the data by hand, step by step. This utilities list is not finalised yet, but will contain among others:

- `hawki_util_distortion`: Apply the distortion correction
- `hawki_util_stitch`: Stiches 4 quadrant images together
- `hawki_util_stdstars`: Generates the standard stars catalog from ascii files
- `hawki_util_gendist`: Generates the distortion map used for the distortion correction

F HAWK-I Burst and Fast Jitter Modes

F.1 The Mode in Nutshell

This section describes a mode for high-cadence and high time-resolution observations with HAWK-I: the fraction of time spent integrating is typically $\sim 80\%$ of the execution time, and the minimum DIT is in the range ~ 0.001 - 0.1 sec. This is achieved by windowed down the detectors to speed up the observations (in other words, to shorten the minimum DIT) and to decrease the overheads.

The burst mode is intended for applications that require short high time resolution observations, i.e. lunar and KBO occultations, transits of extrasolar planets, etc. The Fast Jitter mode is intended for observations of extremely bright objects that require short DITs to avoid saturation, and small overheads, to increase the efficiency, i.e. exo-planetary transits.

As of mid-2010 the burst mode suffers from an extra overhead of 0.15 sec plus one minimum DIT (the exact value depends on the detector windowing but for the most likely window sizes it is a few tens of a second or larger; an upper limit for a non-windowed detectors is $MINDIT \sim 1.8$ sec) associated with each DIT. This makes observations with very high cadence requirements problematic. Addressing this issue requires a modification of the detector readout mode. Efforts to minimize the overheads are under way. Please, check the HAWK-I web page for updates.

The fast photometry may be familiar to the users of fast jitter and burst modes of ISAAC, NaCo, VISIR, and SofI. The main advantage of HAWK-I in comparison with these instruments is the wide field of view that allows broader selection of bright reference sources for relative photometry.

F.2 Description

The HAWK-I detectors are read in 16 vertical stripes each. The stripes span 128×2048 px, and the detectors span 2048×2048 px, each. A window can be defined in **each** of the stripes, but **the locations of the windows are not independent**, i.e. they all move together in a consistent manner that will be described further.

Therefore, the total number of windows for each HAWK-I frame is $4 \times 16 = 64$ because of the 4 detector arrays. Along the X-axis the windows can be contiguous or separated within each detector; note that the four detectors only offer a sparse coverage of the focal plane, i.e. there is space between the arrays, so one can not have a single contiguous window across the entire focal plane. The closest to that are four stripes across each detector.

The detector windows are described by the following parameters:

- `DET.WIN.STARTX` and `DET.WIN.STARTY` – They define the starting point of the window **within** an individual stripe. Note that the X-axes on all detectors increase in the same direction, but the Y-axes on the upper and the lower detectors increase in opposite directions, so when the values of `DET.WIN.STARTX` and `DET.WIN.STARTY` increase, the starting points of the windows move to the right along the X-axis, and towards the central gap along the Y-axis. Note also that these parameters are different than the parameters `DET.WIN.STARTX` and `DET.WIN.STARTY` used to define the windowing in other modes! Values larger than 100 px are recommended for `DET.WIN.STARTY` because the background at the edges of the detectors is higher due to an amplifier glow. The allowed value ranges for `DET.WIN.STARTX` and `DET.WIN.STARTY` are $1..128$ and $1..2048$, respectively but if they are set to 128 and 2048, the window will only be 1×1 px, so the users should select smaller values.

- DET.WIN.NX and DET.WIN.NY – They define the windowing by giving the sizes of the windows in each individual stripe. For example, if the user wants to define a window of 18×28 px on each stripe, the corresponding values of DET.WIN.NX and DET.WIN.NY will be 18 and 28, respectively, but these values will produce a fits file with four extensions, each a data cube with $288 \times 28 \times \text{NDIT}$ because of the 16 stripes in each of the detectors along the X-axis ($18 \times 16 = 288$). The allowed values are 1..128 and 1..2048 for DET.WIN.NX and DET.WIN.NY, respectively, but the users should take care that the starting point plus the size of the window along each axis do not exceed the size of the stripe along that axis.

The FastPhot templates are discussed in details further, but for clarity we will point out here that they work in a distinctly different way, with respect to the templates for other ESO instruments: **the windowing parameters are present only in the acquisition template, and their values are carried over to the science template(s) by the Observing Software. (OS)** To modify the windowing one must re-run the acquisition. If an OB has been aborted, the windowing parameters are remembered by the observing software (as long as the DCS and OS panels have not been reset/restarted) so the OB can simply be restarted, skipping the acquisition.

Figure 13 shows examples of various detector window definitions. For instance, an increase of the parameter DET.WIN.STARTX would move the violet set of windows towards the yellow set, if the other parameters are fixed. Similarly, an increase of the parameter DET.WIN.STARTY would move the violet set towards the solid black set. The dashed black line set corresponds to DET.WIN.NX=128 (128×16 stripes $\times 2$ detectors = 4096 px in total along the X direction) that defines contiguous windows (see bellow).

The minimum DIT depends on both the size and the location of the detector windows. For example: DET.WIN.STARTX=48, DET.WIN.STARTY=1075, DET.WIN.NX=32 and DET.WIN.NY=32, corresponding to windows on the stripes with sizes of 32×32 px ($\sim 3.4 \times 3.4$ arcsec), gives MINDIT=4 millisecc.

An interesting special case is to define contiguous regions (i.e. the windows on the individual stripes are as wide as the stripes themselves, so there are no gaps along the X-axis) - one has to use for example: DET.WIN.STARTX=1, DET.WIN.STARTY=48, DET.WIN.NX=128 and DET.WIN.NY=32, corresponding to windows on the stripes with sizes of 128×32 px ($\sim 13.6 \times 3.4$ arcsec), gives MINDIT=20 millisecc. Note that the stripes are 128 px wide, so this is indeed a contiguous region on each of the detectors, with size 2048×32 px ($\sim 217.7 \times 3.4$ arcsec).

One should try to use as big windows as the requirements for the MINDIT and for lowering the overheads allow because the larger windows greatly help with the target acquisition and tolerate target drifts, inaccurate coordinates, and even give a larger margin for human error – issues that require time to be addressed, which may not be available when observing time-critical events.

The data product is a fits file, with four extensions, each a cube for one of the four detector arrays. Each slice of the cube is a tiled images of all windows, spliced together, i.e. without the gaps that may be present between the individual windows. The Burst sub-mode generates a single fits tile, the FastJitt - as many files as the number of the executed jitters.

The only readout mode for which the new mode is implemented currently is *NonDest*. The new mode works **only** with hardware detector windowing. The difference between the hardware and the other option - the software windowing - is that in the first case only specified portion of the detectors is read, while in the second case the entire detector is read, and the windowing is applied later by software means. The hardware windowing is set explicitly in the templates, and doesn't

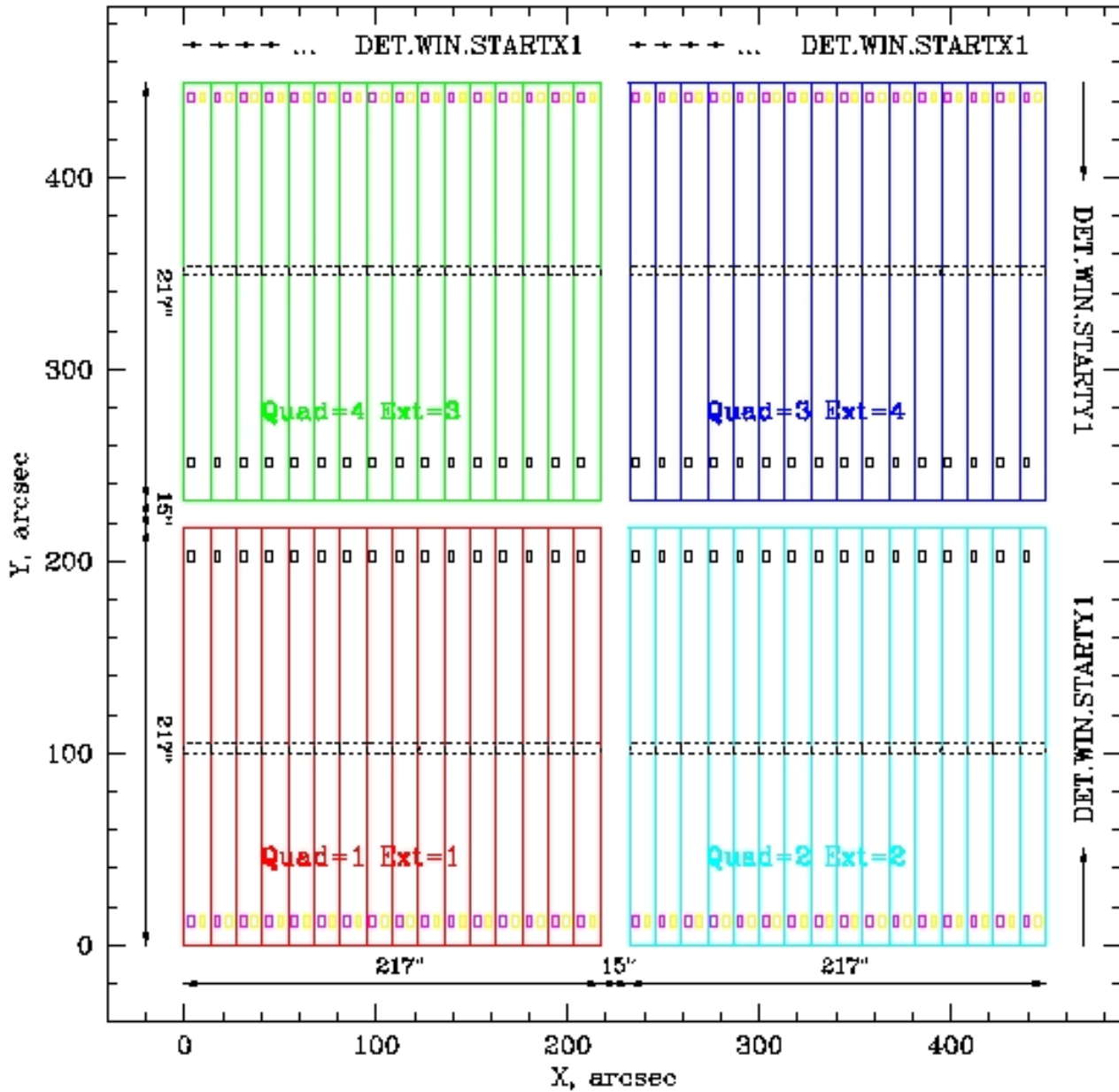

Figure 12: Definition of the windows. The location of the four HAWK-I detectors on the focal plane are shown, as well as the 16 stripes in which each detector is being read. The sizes of the detectors and the gaps, projected on the sky in arcsec are also given. The binaries generated from quadrants 1, 2, 3, and 4 are usually (but not always) stored in fits extensions 1, 2, 4, and 3. Arrows indicate the direction in which the parameters DET.WIN.STARTX, DET.WIN.STARTY, DET.WIN.NX and DET.WIN.NY increase. Note, that the parameter DET.WIN.STARTX defines the starting point of the window, counted from the beginning of each detector stripe, not from the beginning of the detector. Note that all these parameters are defined in pixels, although this figure is plotted in arcsec. Four different sets of windows are shown in violet, yellow, solid and dashed black lines.

require action on the part of the user.

F.3 Timing Information

The minimum DIT and the execution time for some parameter combinations are listed in Table 5. These values may change quickly, for the latest information please check the HAWK-I web pages.

Table 5: Timing Parameters for $\text{NDIT} \times \text{DIT} = 1000 \times 1 \text{ sec} = 1000 \text{ sec}$ of integration. The 32 and 2 multiplication factors are given to remind the user that the NX and NY parameters are the total width of the detector windows across the entire set of stripes. The readout mode is NonDest.

STARTX	NX	STARTY	NY	MINDIT, sec	Exec. Time, sec	Overhead, sec	Overhead per DIT, sec
1	64	128	64	0.0260	1174	174	0.174
1	64	128	128	0.0517	1199	199	0.199
1	128	128	64	0.0506	1198	198	0.198
1	128	128	128	0.1008	1248	248	0.248
1	128	128	256	0.2013	1349	349	0.349
1	128	1792	128	0.1037	1251	251	0.251
1	32	128	32	0.0070	1155	155	0.155

F.4 Preparation and Observation

F.4.1 OB Naming Convention

Following the common convention for the fast modes:

- *FastJitter* OBs (BURST=F) should start with the prefix "FAST" in their name,
- *Burst* OBs (BURST=T) which does not make use of the EVENT keywords (EVENT.DATE=0 and EVENT.TIME=0) should start with the prefix "BURST" in their name,
- *Burst* OBs (BURST=T) which make use of the EVENT keywords (EVENT.DATE=YYMMDD and EVENT.TIME=HHMMSS) need to include the time at which the science template (not the acquisition!) should start, i.e. the UT time of the EVENT time minus half the total exposure time. For example, let us assume that you are exposing for 30sec in total and lets assume that your event occurs at UT date YYMMDD and UT time HHMMSS, then, your OB name should include the following prefix: BURSTUTYYMMDDHHMMss, where $ss = SS - 30/2 = SS - 15$.

F.4.2 OB Requirements and Finding Charts

The *Burst* mode OBs are allowed to use the *HAWKI_img_acq_Preset* template. This is necessary for example, for Lunar occultations where a large number of events can be followed in a row, with small intervals in between. The OBs making use of this acquisition template do not need

an attached finding chart. It will be responsibility of the user to double check his/her coordinates since this is in effect a “blind” telescope pointing. The typical accuracy of the VLT pointings is bellow 1 arcsec.

Remember, that the windowing is defined in the specialized acquisition template it `HAWKI_img_acq_FastPhot`. These parameters can not be modified with the `HAWKI_img_acq_Preset` template. Therefore, `HAWKI_img_acq_FastPhot` must be executed at least once, and the windowing parameters should be kept the same during the entire sequence. The usage of `HAWKI_img_acq_Preset` template is allowed only in Visitor mode, and it is forbidden in Service.

For more details on the templates see Sec. F.5).

The finding chart requirements are the same as for the other VLT instruments.

F.4.3 Observing Modes

The *Burst* and *FastJitter* modes are offered both in Visitor and in Service modes. However, in the case of Lunar occultations, only disappearances are offered in Service. Visitor mode must be requested in the case of appearances.

F.4.4 Calibration Plan

- Darks taken with the same windowing and readout mode (the latter is valid only if and when other readout modes are offered),
- Twilight Flats, non-windowed and with the same filters as the science observations are offered, the users only have to excise from them the relevant windows; we compared windowed and non-windowed K_S flats and found no significant difference (Fig. 13).

F.4.5 FITS Files Names

The file names for the fast mode should contain “FAST” for clarity. The extentions SAMPLE and DIT are also appended to the FITS file name.

F.5 Template Guide

F.5.1 Acquisition: `HAWKI_img_acq_FastPhot`

The template is similar to the `ISAACLW_img_acq_FastPhot`. The action sequence performed by the template includes:

1. Preset the telescope, set up the instrument (no windowing at this stage, the full field of view is shown on the RTD).
2. Move to the sky position, take a non-windowed image, ask the operator to save it in the RTD and to turn on the sky subtraction
3. Take a non-windowed image of the field of view, ask the operator if an adjustment is necessary. Note that the adjustment here includes both the telescope pointing (and field of view orientation), and the detector windowing parameters. At this stage the operator is expected

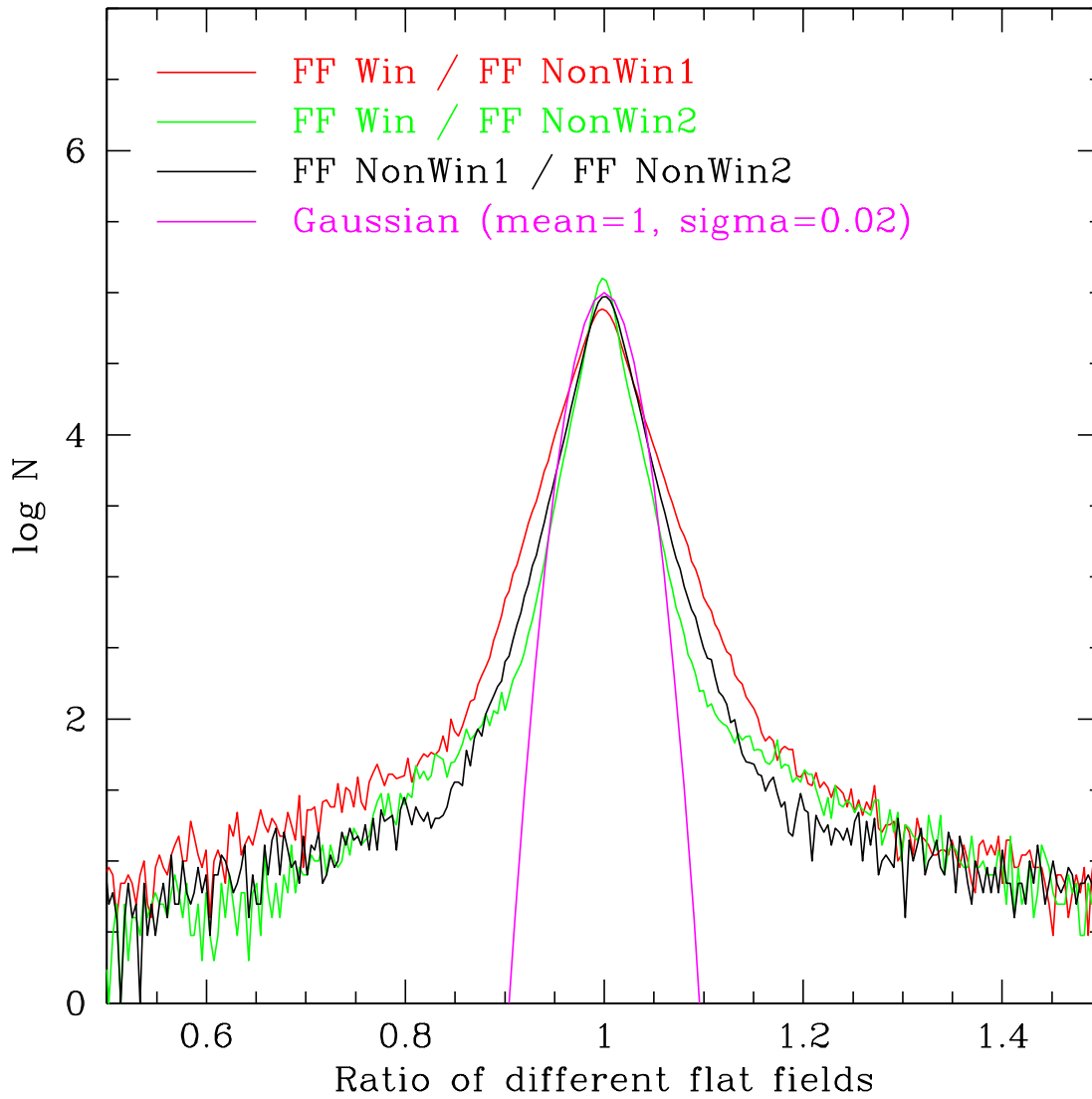

Figure 13: Histograms of the ratios between a windowed and two non-windowed K_S twilight flats. For comparison, the ratio of the two non-windowed flats and a Gaussian function is also shown.

to press the "draw" button that draws on the RTD the windowing as defined in the acquisition template. The operator can modify it at any time from now on, but has to redraw to have the latest version shown on the RTD.

4. If the operator gives a negative answer, the template acquires an image, saves it, and then ends. Otherwise, an offset window is opened on the RTD to let the operator to define an offset and rotator angle offset (and to modify the windowing parameters).
5. The offsets (including the rotator offsets) are sent to the telescope and after they are executed, the template returns to item 3

The windowing parameters defined in the acquisition template are stored in OS registers, and used by the science template later. They can be accessed by the science template even if it has been aborted and restarted multiple times, as long as the OS has not been stopped and restarted.

Some additional details:

- The new windowing parameters (DET.WIN.STARTX, DET.WIN.STARTY, DET.WIN.NX and DET.WIN.NY) are this template. They are used to draw on the RTD the locations of the 32 windows.
- The parameters BADAG and BADA0 determine if the template checks and waits for guiding and active optics (*False* - check, *True* - no check). These parameters are "hidden", i.e. they are not available to the user via the P2PP and if the user requires degraded AO performance (for example, because of extremely bright target), they should request this in the README. The BADAG is best left unchanged. Please, consult the HAWK-I saturation limiting magnitudes given earlier in this manual.

F.5.2 Science template: *HAWKI_img_obs_FastPhot*

This template is similar to the *ISAACLW_img_obs_FastPhot*. It operates in two modes: *Burst* and *FastJitter*. In *Burst* mode the telescope is staring at the target for the duration of the integration ($INT=NDIT \times DIT$) and only one data cube is produced. In *FastJitter* mode, the telescope can jitter in the sky and many data cubes can be produced within one template.

In *Burst* mode it is possible to set the absolute time on which the observation has to be centered. For example, this is the case of Lunar occultations: if one wants to observe an event at time T and sets a total integration of 60 seconds, the template will start to collect data at $time=T-30$ and end at $T+30$. The template ignores the timing parameters, if they are set to zero.

Action sequence performed by the template is identical to that of the *HAWKI_img_obs_AutoJitter* template:

1. Sets up the instrument, including selection hardware detector windowing.
2. Performs a random offset (most users are likely to set the jitter box size to zero to keep the objects located on the same pixels, which should reduce systematic effects from imperfect flat fielding).
3. Acquires a images stored in a cube, and continues as long as the number of the frames in the cube is equal to the value of the parameter DET.NDIT (this parameter defines the length of the cube).

4. Goes back to step and repeats the actions until SEQ.NEXPO cubes are collected.

Specific details:

- The new windowing parameters (DET.WIN.STARTX, DET.WIN.STARTY, DET.WIN.NX and DET.WIN.NY) are not accessible to the user from this template.
- The parameter DET.BURST.MODE selected between Burst (*True*) and Fast Jitter (*False*) modes.
- The parameters: EVENT.DATE and EVENT.TIME define the time at which the observation has to be centered. They are ignored if DET.BURST.MODE is set to *False*. They are also ignored if they are set to zero to streamline the usage of the *Burst* mode for non-time critical observations (i.e. for lucky imaging).
- Readout mode is set to *NonDest* because for now this is the only one for which the new windowing is implemented.
- The hardware windowing is set to true (implicitly for the use).
- The store-in-cube option is set to *True*.
- The parameters BADAG and BADA0 determine if the template checks and waits for guiding and active optics (*False* - check, *True* - no check).

F.5.3 Calibration templates: *HAWKI_img_cal_DarksFastPhot*

Twilight flats for this mode are obtained with the normal non-windowing *HAWKI_img_cal_TwFlats* template making the dark current calibration template *HAWKI_img_cal_DarksFastPhot* the only unique calibration template for the fast mode. It is similar to the usual dark current template *HAWKI_img_cal_Darks*, with the execution of the hardware windowing and the storage of the data in cubes. The parameters for filter, DIT, and NDIT are lists, allowing to obtain multiple darks in one go.

Specific details:

- The new windowing parameters (DET.WIN.STARTX, DET.WIN.STARTY, DET.WIN.NX and DET.WIN.NY) define the detector windowing. As in the science template, they are used to window the detectors but unlike the science template they are explicitly defineable and accessible by the users.
- The parameter is not available in the calibration templates. All the calibration are taken as reconstructed images, in other words DET.BURST.MODE is internally always set to *False*.
- Readout mode is set in the template implicitly to *NonDest* because for now this is the only one for which the new windowing is implemented.
- The hardware windowing is set to true.
- The store-in-cube option is set to true.