

MAIN LIBRARY

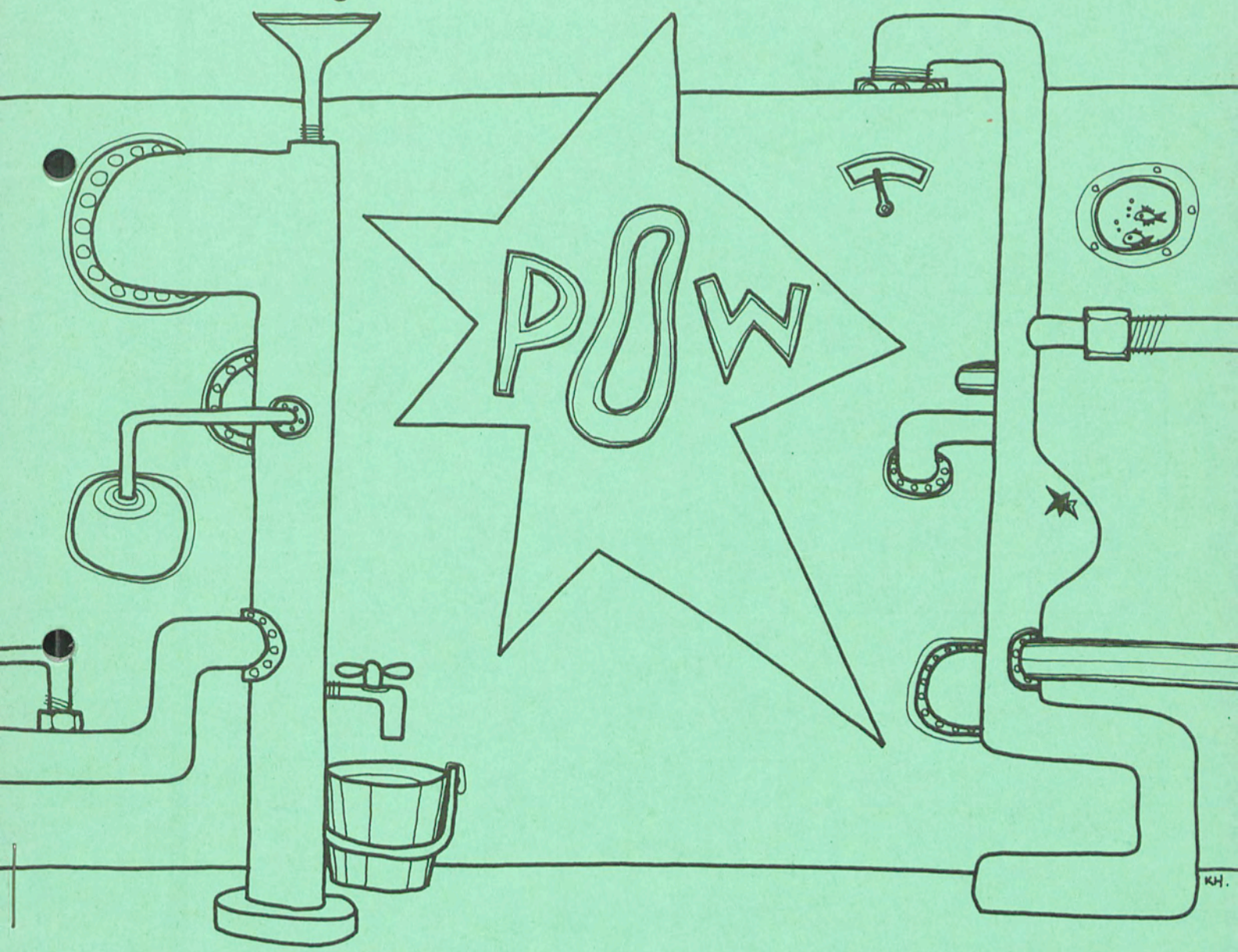

# 3.6m telescope MAINTENANCE MANUAL NUMBER 9

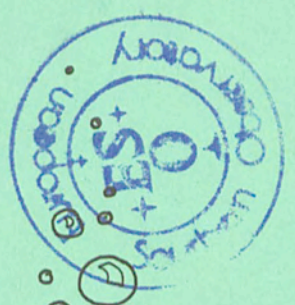

## ALUMINIZING PLANT

## CONTENT

	PAGE
1. Introduction	2
2. Vacuum Plant General Description	3
2.1 Introduction	3
2.2 System Components and their function	3
2.3 Vacuum Pumping System	4
a - Backing pump	4
b - Booster pump	5
c - Small backing pump	7
d - Diffusion pump	8
2.4 Gate Valves	9
2.5 Pressure gauges	9
a - Thermovac gauge	9
b - Combitron CM 30 gauge	10
c - Residual gas analyzer	10
2.6 Film Thickness Monitor	11
2.7 Liquid Nitrogen level control	12
3. Vacuum Chamber preparation for aluminizing	13
3.1 Loading Filaments	13
3.2 Preparation of mirror's fixation on the cover	13
4. Cleaning of Mirrors	14
4.1 Introductory remarks	14
4.2 Chemicals	14
4.3 Cleaning	15
4.4 Handling and last cleaning	16
5. Aluminizing Process	17
6. Firm addresses	19

## 1. INTRODUCTION

This manual mainly gives descriptions and operation instructions of mirror preparation and aluminization facilities available for the 3.6-m telescope; in the second part handling and cleaning procedures are indicated which are necessary to bring mirrors into the vacuum chamber in proper conditions; the last part will indicate the aluminization procedure itself.

Five mirrors are concerned by the following procedure:

- the main mirror (concave)
- the Cassegrain secondary mirror (convex)
- the Coudé secondary mirror (convex)
- the third Coudé mirror (flat)
- the fourth Coudé mirror (flat)

## 2. VACUUM PLANT

### GENERAL DESCRIPTION

#### 2.1 Introduction

This system's primary function is to evaporate, in vacuo, a coating of aluminium on the front surface of the 3.6-m telescope mirrors (primary mirror, Cassegrain secondary, Coudé 2, 3, 4) to provide a highly reflective surface. Coudé 5 mirror is aluminized with the 1.6-meter Edwards vacuum chamber.

The aluminizing plant for the 3.6-m mirrors has been manufactured by High Vacuum Equipment Corporation at Hingham, Boston.

#### 2.2 System Components and their Function

Each component of the system has a function related to the aluminizing of the mirror and the transport of the system inside the observatory. The component function is as follows:

- Horizontal Vacuum Chamber = this chamber encloses the mirror and supports the filament array, glow discharge array and the Meissner trap.

- Mirror center support = the mirror center support is attached to the cover plate and the mirror is mounted and locked on the support for transport and aluminizing. The primary mirror is supported by a metallic cylinder adjusted inside its center hole while the other mirrors are supported by an external ring.

- Cover plate = the cover plate is mounted on the carriage drive assembly. It supports the mirror and seals the chamber for evacuation.

- Carriage and drive assembly = this system is designed to move the cover plate and mirror to engage the chamber for aluminizing. It has two speeds, controlled from a fixed or a remote panel, and travels on rails mounted on the observatory floor.

- Wheel assembly = this is the assembly of the drive and wheels which support the carriage and cover plate.

- Glow discharge = this array provides an ion bombardment or plasma to clean the surface of the mirror after it is installed and under vacuum.

- Filament array shield = this shield has a number of holes aligned with the evaporant filaments. The holes tend to focus the evaporant and provide specular coatings on the mirror. The holes are disposed on two circles, the external used for the primary mirror and the internal used for smaller mirrors. Also the shield acts as a barrier for the four

getter filaments and prevents interaction between the filaments and the glow discharge.

- Circuit diagram = this diagram shows the electric circuitry in schematic form for information and troubleshooting.

- Vacuum pumping system = this system is designed to evacuate the chamber to a pressure of  $2 \times 10^{-6}$  torr or less.

- Meissner trap = the purpose of this trap is to condense water vapor and gases that will condense at LN temperature inside the vacuum chamber.

### 2.3 Vacuum Pumping System

Short description and routine maintenance.

#### 2.3.a - Backing pump, manufactured by Kinney Vacuum Company. Model KT 500 B triplex pump.

The pump is an oiled sealed, rotary piston type vacuum pump. The pump functions by drawing air in at the pump inlet for almost one full revolution and then compressing it for almost another revolution until adequate pressure is reached to discharge it from the pump. Both cycles are performed simultaneously, one side of the piston draws in air while the other side compresses air drawn in on a previous cycle. The triplex pump has three cams and pistons pumping in parallel, driven by a common shaft.

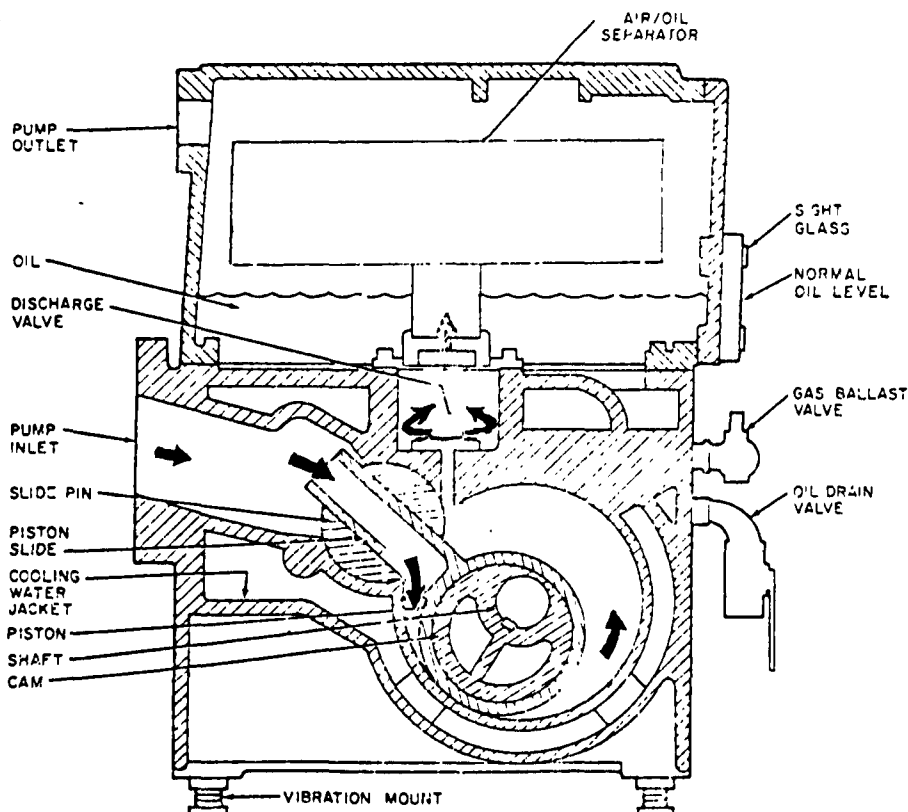

CROSS SECTION OF THE BACKING PUMP

Operation: it is a good practice to run the pump at blank off until the temperature has reached operating level, in order to minimize differential expansion effect between the internal parts and the cylinder. KT 500 B model must be run at blank off for 15 minutes before opening the suction of the pump to a higher air pressure.

Starting the pump:

- close the isolation valve
- open the cooling water flow
- start pump
- adjust the gas ballast valve: with the pump operating, fully open the gas ballast valve during periods when this will not affect the process (work preparation, recycling, etc.). This will aid in cleaning the oil.

Stopping the pump:

- close isolation valve
- vent pump to atmosphere through gas ballast valve
- stop pump
- shut off cooling water.

Maintenance - oil contamination

When the pump has operated satisfactorily for some time and then gradually the vacuum becomes poor, clean the oil by applying gas ballast, or change the oil.

Oil capacity 12 US Gals used only Kinney type A oil.

Filling the pump with oil: remove the filler plug at the top of the separator housing and add oil until the level reaches the top of the right gauge. The level will drop to mid-center of the gauge once the pump is operated at blank off and the oil is distributed. Add or drain oil as necessary to keep the oil level within the gauge range. The oil level changes with operating pressure, reaching the lowest level at blank-off.

Usual troubleshooting: excessive pump noise at low pressures due to hydraulic noise of pump discharge; remedy = open gas ballast valve.

2.3.b - Booster pump, manufactured by Kinney Vacuum Company.  
Model KMBD 1602.

Pump construction consists of two figure eight shaped rotors enclosed in a machine housing supported at each end by ball bearings. The drive power turns the drive rotor directly and rotates the driven rotor by means of helical gears, which have low backlash. Vacuum pumping is accomplished by trapping a volume of air between each rotor and the pump housing. By revolving the

rotors, this volume is carried to the exhaust side of the pump and then discharged as shown on the following figure.

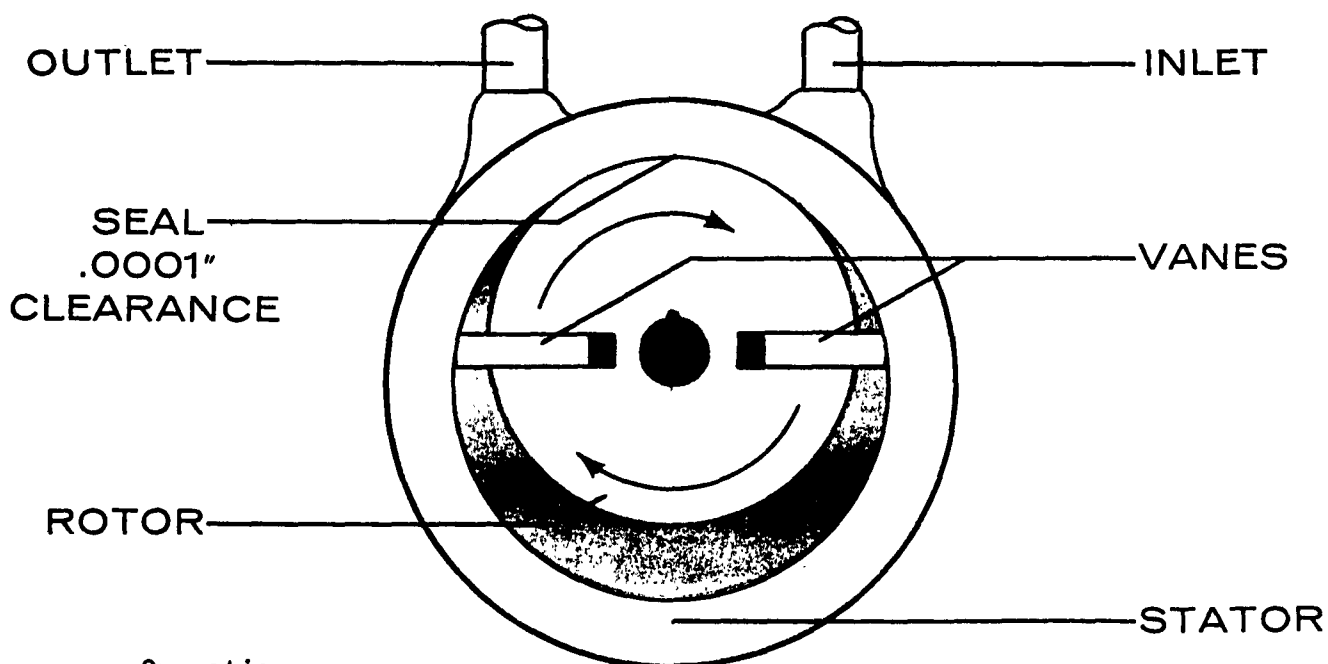

### Operation

#### Starting the pump:

The cooling water flow is opened with the same Tap as used for the cooling of the backing pump, besides a flow switch stops the pump when the flow is interrupted.

- pump down the system with the backing pump to a pressure of 70 torr
- start the booster pump. A pressure switch arrangement is included in the unit to stop the booster pump if the backing pressure of 70 torr is not reached.

#### Stopping the pump:

- stop the booster by turning off motor power. Do not stop the pump by increasing pressure to open the pressure switch.
- stop the backing pump
- turn off the cooling water supply.

### Maintenance

Lubrication - use Kinney Super X or type A oil. The booster pump should have the same oil as the backing pump. The booster oil quantity is 1 US Gal.

To fill pump, proceed as follows:

- remove oil fill plugs on each end cover and pour in the oil. The oil level should be about midway at the sight glasses

- on each end,
- replace oil fill plugs, using a light coat of Kinseal on the threads. Oil cannot be added to the ends while the booster is operating, because the oil reservoirs are under inter-stage vacuum.

To drain pump oil proceed as follows:

- remove the drain plugs from bottom of both end covers. Remove both fill plugs,
- when oil is drained, replace all plugs, using a light coat of Kinseal on the threads.

Under normal operating conditions check the oil level every 24 hours of continuous operation and the oil should be changed every 800 hours of operation.

- 2.3.c - Small backing pump, manufactured by WELCH Scientific Company. The Welch duo-seal pump consists of a rotor mounted concentrically on the drive shaft and positioned eccentrically in a cylindrical stator. The rotor is fitted with two spring loaded, diametrically-opposed vanes which move in and out of their slots, always pressing against the inner surface of the stator ring. The vane sweeps the air from the crescent-shaped space and forces it out the one-way exhaust valve. This operation is repeated twice each revolution.



## Oil changes and level

To change oil disconnect the pump from the system. Warm the oil by operating the pump with the intake closed, for approximately 15 minutes. Stop the pump and remove the oil drain cap. Most of the oil will drain out freely. Caution, oil will be hot. The small residue remaining in the pump can be forced out by turning the pump pulley by hand. After removing all oil, close the drain and pour clean Duo-Seal oil into the intake port. Fill to proper level indicated on the sight glass.

### 2.3.d - HS 32 PURIFYING Diffusion Pump, manufactured by Varian Lexington Vacuum Division.

In this pump the oil is vaporized by a heater and emerges as a high velocity stream from the pump nozzle. Gas molecules from the system diffuse into the jet stream and undergo collisions with the vaporized oil. These collisions impart a downward velocity to the gas molecules. The gas is forced downstream, compressed and removed from the system by the forepump.

#### Operation

##### Starting the pump:

- turn on cooling water. A flow switch stops the pump when there is no water circulation.
- turn on power to the diffusion pump when the backing pump has reached a pressure of 10 microns. If the backing pressure increases a pressure switch will stop the diffusion pump heating.

##### Stopping the pump:

- turn off the power to the pump,
- let water circulate for an hour until boiler area is cool to touch,
- stop the forepump and admit air to the system,
- turn off cooling water.

#### Special precautions

Do not admit air to the diffusion pump while the heater is turned on. An exposure for more than a few seconds to atmospheric pressure while the pump is hot will cause the heat sensitive diffusion pump oil to break down and will need cleaning the pump and replacing the oil.

#### Maintenance - oil level sight glass.

The valves of the assembly are in the open position with the handles horizontal. Set the scale with the top left hand line corresponding to the actual oil level and clamp scale tightly.

During operation, some surging of the oil level is normally seen. Use only diffusion pump oil DC 704 or DC 705 oil capacity 3 gallons.

## 2.4 Gate valves

Electro-pneumatic actuation valves are used to isolate the various pumps and also to isolate the vacuum chamber and the pumps. Besides a handwheel actuation valve is used to isolate the chamber and the atmosphere. All the valves are manufactured by AIRCO Tenescal.

Operation: air pressure to operate air actuated types must be between 4,8 Kg/cm<sup>2</sup> and 9,5 Kg/cm<sup>2</sup>. Higher pressures may damage the piston actuator. (Usual pressure 8 Kg/cm<sup>2</sup>)

Do not excessively tighten or adjust the hand operated valves. Check for O-ring damage and cleanliness if leakage should occur.

### Maintenance

- Recommended Cleaning Agents  
Metal parts - acetone  
O-rings - methyl alcohol, do not use acetone.
- Recommended lubricants / grease.  
Valve seal gaskets and O-rings = Dow Corning High Vacuum grease.  
Actuating Mechanism = light machine oil.

## 2.5 Pressure Gauges

Various vacuum gauges are used to check the pressure in several points of the system.

- 2.5.a - Thermovac gauge, manufactured by Leyhold Heraus measuring range  $10^{-3}$  to 760 torr, response time = 20 ms.

Operation: within certain limits, the thermal conductivity of a gas is dependent on its pressure. This physical phenomenon is utilized for the purpose of pressure measurement in thermal conductivity vacuum gauges. The sensing filament located in the gauge tube forms a branch of a Wheatstone bridge circuit. The heating potential applied to this bridge is so regulated that the resistance and therefore the temperature of the sensing filament remains constant independent of the rate of heat loss from the filament; this means that the bridge remains permanently balanced. Since the rate of transfer of heat from the sensing filament to the gas increases with rising gas pressure, the potential applied to the bridge is a measure of the pressure. The measuring potential is corrected by electronic means in such a way that an approximately logarithmic response is achieved over the entire measuring range.

Pressure switches: the required switch point can be set on the front panel when the pressure drops below the switch point, a relay is energized, a pilot lamp lights up.

Fault indicator: the built-in fault indicator is activated if the sensing filament breaks or the sensing tube is disconnected.

Maintenance: the sensing tube can be cleaned by the use of suitable solvents (benzene,  $\text{CCl}_4$ , ether). Mechanical cleaning methods such as brushing must not be used, as the sensing filament would be destroyed.

#### 2.5.b - Combitron CM 30 gauge, manufactured by Leyhold-Heraus.

In the Combitron CM 30 both the vacuum gauges Thermovac and Penningvac PM 30 are included in one instrument thereby covering the complete measuring range  $10^{-6}$  to 760 torr.

Operation: the high voltage supplied by the control unit to the penningvac gauge head induces a pressure-dependent electric discharge between anode and cathode that is maintained by means of the magnetic field of the permanent magnet of the gauge head.

Measuring: select thermovac gauge T1 or T2 by means of push button switch for gauge selection. For the pressure range  $10^{-6}$  to  $10^{-2}$  torr push selector switch P. Read the pressure on the middle scale P in torr. Do not push selector switch button P when the pressure is known to be higher than  $10^{-2}$  torr. When frequently pressing this switch at higher pressure the gauge head might become very quickly contaminated.

Maintenance: cleaning the Penningvac gauge tube.

The anode and the cathode plate can be exchanged if necessary. Clean with fine emery paper anode and cathode after removing, the glass insulator internal surface should be very carefully washed with solvent. After thoroughly cleaning, the reassembled head should be once again washed through with solvents and then dried to remove any possible contamination such as fingerprints.

#### 2.5.c - Residual gas analyzer, model SPI-10 manufactured by Veeco.

Description: the Veeco SPI-10 Single Pole Residual Gas Analyzer consists of three major systems: the analyzer tube, electronics (RF) head and control module.

##### 1. Analyzer Tube

The analyzer tube is the heart of the SPI-10 system and is comprised of the ion source, the analyzing region and the collector. The tube is of all stainless steel construction. Electrical connections (feedthroughs) are of a special ceramic-to-metal design. The leads are nickel-coated stainless steel.

The analyzer tube source includes two replaceable filaments. The design of the filament assembly and mounting is such that replacement is simple and alignment automatic; no critical adjustments are required.

## 2. Electronics (RF) Head

The RF head houses the highly sensitive MOSFET amplification system and the RF generator. Due to the high sensitivity of the amplifier, it is attached directly to the analyzer tube to avoid any external electrostatic interference that may result from interconnecting cables. The ion current from the analyzer tube is fed directly into the electronics head where it is amplified. Due to the high sensitivity of this amplifier, the analyzer tube uses no electron multiplier.

## 3. Control Module

The control module houses the oscilloscope and all necessary power supplies and controls for operation of the RF head and analyzer tube.

Mass spectra are produced by varying the amplitude of the RF voltage supplied to the analyzer tube. This, in effect, forces the ions in the tube to oscillate at different amplitudes. Since the amplitude of the ion is proportional to the amplitude of the RF voltage and the ionic mass, only ions with a certain mass will follow a trajectory that allows detection. Thus a mass spectrum is produced; besides, when placed in the total pressure position, the SPI-10 system is converted into a means for measuring total pressure within the vacuum system being monitored. In this position the SPI-10 will have a sweep trace of fixed duration displayed on the scope and the ion current meter will indicate a signal level proportional to total pressure of gas sampled within the vacuum chamber.

For spectral interpretation see the manual supplied by Veeco.

### 2.6 Film Thickness monitor OM 300, manufactured by Kronos, Inc.

The Kronos digital film thickness monitor measures and displays the change in thickness of aluminium deposited on a transducer located near the surface of the mirror. The linearity of period measurement results from the direct application of the basic equation governing the oscillation of a quartz crystal  $\tau = kT$ . For any changes in thickness  $\Delta\tau = k\Delta T$  where  $\tau$  is the period of oscillation of the quartz crystal,  $k$  is a constant. In the case of Aluminium, the variable scaling thumbwheel switches located on the front panel are set at 370. For astronomical mirrors the ideal aluminium thickness must be between 800 Å and 1000 Å, then on the thickness display one can push the 10 KÅ button providing 9.999 KÅ full scale reading, in this range the thickness resolution is 1 Å  $\pm$  0.1% of full scale. For stable operation the monitor should be allowed to warm up and to stabilize

for 30 minutes before use.

Maintenance: Be sure to use recommended replacement crystals obtainable only from Kronos, Inc. The crystal must be properly centered under aperture. Clean crystal with acetone and do not contact electrodes with fingers.

2.7 Liquid nitrogen level control model F77, manufactured by High vacuum equipment.

The F77 model is an all electric liquid level controller. The thermistor probe bodies are normally self heated by means of current which passes through them. Since heat is dissipated more rapidly when a probe body is immersed in the liquid than when it is exposed, the change in body temperature effects a change in the circuit electrical resistance. This change in resistance varies the bias of transistor amplifiers in the F77 control which in turn control a relay. The relay then causes a remote control valve to open or close depending on the level of the cooling agent.

### 3. VACUUM CHAMBER PREPARATION FOR ALUMINIZING

#### 3.1 Filaments' Loading

- For the primary mirror, filaments with a basket shape are placed on the outer ring. Be sure that the correct connection of the power on the ring is done. Filaments are washed with acetone and are handled with gloves. Filaments have to be clamped so that the very ends of the filaments are held tightly, otherwise the filament could be cooled at the ends due to thermal conduction through the copper filament holders. This will cause incomplete evaporation. Position the filaments so that they are horizontal and centrally located in front of the focusing holes in the shields. New filaments should be installed for each aluminization of the main mirror. Use four aluminium clips 18 mm long on each filament. Clips must be handled with tweezers after cleaning with acetone.
- For small mirrors, filaments are placed on the inner ring. Use 3 aluminium clips 18 mm long on each filament.
- For all aluminizing, it is necessary to load the four getter filaments with four aluminium clips 18 mm long. These filaments can be used three or four times. For loading or installation of getter filaments unscrew and open the four small doors on the main shield. Two mirrors allow to see the filaments from outside when the chamber is closed, these mirrors have to be adjusted after all operations on filaments. Sometimes the rear looking window must be removed and cleaned with the same procedure as for mirror cleaning.

#### 3.2 Preparation of mirror's fixation on the cover

- Primary mirror, the main mirror is fixed on the cover by means of a metallic cylinder going through its central hole. This adjustable cylinder is fixed on the cover itself by means of 6 hexagonal socket head screws M 24.
- Small mirrors, they are fixed by means of an external ring used also for their transportation. This frame is fixed by 4 hexagonal socket head screws M 16 on four steel spacers. The preparation consists of fixing these four steel spacers on the cover. After the previous operations install the thickness sensor in such a manner that the exposed face of the crystal is directly facing the source so that it will receive, as closely as possible the same rate of deposit as the mirror does. The chamber interior must be perfectly clean with cotton and alcohol as well as the mirror support. Clean the O ring on the flanch of the tank with alcohol, also the opposite side. Put inside the chamber a plate with drying agent. Then the chamber is closed and pump down. All the previous operation should be done one day before aluminizing. in order to outgas completely the chamber.

## 4. CLEANING OF MIRRORS

### 4.1 Introductory Remarks

The room where the cleaning is done should be clean, orderly and free of dust. During the later phases of the mirror cleaning, smoking and opening of doors should be strictly forbidden, avoid to speak in the direction of the mirror (spitting). During all phases of the work on the mirror one should have frequently washed hands (there should be several clean towels) and short sleeves. Clothes that are not dusty should preferably be worn (nylon). All materials that are used on the mirror should be checked for solid particles that may cause scratches.

In principle, lyes and acids, should only be used in diluted form. Concentrated lyes can affect the polish. Concentrated acids are relatively harmless. Be careful with liquids in which solids are dissolved or suspended = normal water (chalk), lyes (NaOH, KOH). Such agents should be continuously distributed over the surface, sufficiently diluted with water and finally, be washed away thoroughly with another agent not containing solid particles = HCl, demineralized water, alcohol.

### 4.2 Chemical Formulas for the different solutions

Sodiumhydroxide, NaOH 5% = 1000 cm<sup>3</sup> distilled water + 50 gr NaOH pastils  
Potassiumhydroxide, KOH 10% = 1000 cm<sup>3</sup> distilled water + 100 gr KOH pastils  
Mercurichloride HgCl<sub>2</sub> (2.5%) = 1000 cm<sup>3</sup> distilled water + 25 gr HgCl<sub>2</sub> powder  
Hydrochloric acid 1:4 with coppersulphate = 680 cm<sup>3</sup> HCl (37%)  
320 cm<sup>3</sup> distilled water + 1/4 tea-spoon CuSO<sub>4</sub>

All chemicals to be dissolved in a tray and enter into bottles through a filter. Carefully indicate on each bottle its contents. Some solutions develop some heat while being prepared (KOH, NaOH, HCl & CuSO<sub>4</sub>). Prepare them beforehand so that they are at room temperature at the moment they should be used.

Other chemicals and materials to be used:

- Products from E. MERCK, A.G. Darmstadt
- Propanol(2) zur analyse =
- Chloroform zur analyse
- di - Phosphorpentoxid zur analyse (drving agent)
- Natriumhydroxid Plätzchen
- Teepol = Shell liquid detergent

- Alcohol absoluto para uso medicinal from droguería Michelson S.A. Santiago
- Aluminium clips to be ordered via Edwards High Vacuum
- tungsten filaments
- use clean rubber gloves

#### 4.3 Cleaning of the mirror

For the main mirror don't forget to prepare the three rubber supports of which location is painted on the floor. For smaller mirrors the mobil wash-basin will be used.

Before letting the mirror clean its back side. This can best be done while it is hanging on the crane. Especially grease and marks from metallic (lead) contacts have to be removed well.

Before resting the mirror on the rubber or teflon supports, clean those supports.

- Make the mirror dust-free: this is done by rinsing thoroughly with ordinary water (through two hoses located on the left wall of the room). No other means should be used since all friction may cause the dust to scratch the mirror. Even the water should not be applied to the mirror with force.

- Immediately after, i.e., before the water has had even the slightest chance to dry, make the mirror dirt and grease free. This is done by washing with Teepol diluted with ordinary water in the ratio 1:10. Use soft paper pads to apply the Teepol to the mirror, but do not rub or even press. Clean the soap off by rinsing well with the water hose. If there remain dirty or greasy spots, repeat the operation until the mirror is satisfactorily clean. At each next application one may rub a little bit more, but really heavy friction should be avoided. If rests of dirt or grease are staying on the mirror, these will delay the removal of the old aluminium coat at the next step of the operation. Finally, the mirror is dried with cotton or soft paper without rubbing or other friction.

If the mirror is sufficiently clean and it is still necessary to aluminize it (sometimes after washing of the dirt one finds a remarkably good mirror that one should hesitate to aluminize anew), the following method is applied. For the main mirror a teflon ring is put in the center hole in order to retain chemical products. If the mirror is convex, build a dike of cotton along the edge of the mirror. At the next step one should choose either the KOH or the  $\text{HCl}_2$  for removing the aluminium.

- Put large pieces of soft paper on the mirror and soak them with KOH, pour also over the whole surface. With the paper keep the KOH well distributed over the mirror. The paper should be renewed very often. Clean also the sides of the



mirror but be careful not to bring dirt from the sides onto the surface again. When all aluminium has been removed, rinse well with demineralized water.

- Put some pieces of paper on the mirror and soak them with (HCl + CuSO<sub>4</sub>). pour it also over the whole surface. Do not forget the sides of the mirror and give special attention to its edge.

- Rinse the mirror well with distilled water. Dry a bit with paper, do not forget the sides of the mirror nor the central hole. A piece of paper that once has passed over the side of the mirror should never come back to the optical surface.

- Clean and dry the mirror with alcohol. Rub gently and make sure that the alcohol does not dry by itself, but rather under the rubbing action. Especially for this step a high quality paper is essential.

- Apply the breathing test: if one sees a blue uniform film rapidly evaporating from the edge to the center, the mirror can be put immediately in the tank; if not, start again to clean applying the previous procedure.

#### 4.4 Handling and Last Cleaning

- As soon as the mirror is clean enough and hanging on the crane, clean its back side with alcohol. Turn the mirror into its vertical position.

Now one fixes the mirror on the cover using the center support and a triangular arm as a security to retain the main mirror or using an external frame for the smaller mirrors. Check that the thickness sensor is in correct position.

Clean the mirror with the static master radioactive anti-static brush. (Model 3C500). Then the carriage which supports the cover and the mirror can be driven at low speed to shut the chamber using either the fixed command console or the remote control. The cover must be slightly tilted to adjust its parallelism with the chamber's flange. Tight the cover using the external clamps. Connect the coaxial cable to the thickness sensor.

## 5. ALUMINIZATION PROCESS

- Ensure that all valves are in the closed position. The chamber's inlet valve and the inlet valve corresponding to the space between the two O-rings are closed with their handwheels fully clockwise.
- water on to mechanical pump.

The vacuum system is now ready for operation. Refer to the graphic panel on the control console when operating the vacuum system. Using the test light switch on the graphic panel, check all lights.

- Start diffusion pump
  - power on to control console
  - water on to diffusion pump
  - air on to the electro-pneumatic valves
  - connect LN<sub>2</sub> from LN<sub>2</sub> dewar to the diffusion pump trap
  - power on to the small backing pump
  - open the holding pump valve between diffusion and small backing pumps
  - power on to the diffusion pump
  - start the backing pump
  - open the roughing valve
  - check the pressure at the holding pump and at the backing pump read on the combitron and thermovac gauges
  - after 10 minutes when the pressure is less than 70 torr start the booster pump
  - in about 25 minutes the chamber is evacuated to a pressure of  $1.5 \cdot 10^{-2}$  torr
  - pressure control ON (glow discharge power supply' panel)
  - start air inlet to the chamber via the throttle valve to maintain the pressure around  $2.5 \cdot 10^{-2}$  for best glow discharge results
  - start the glow discharge controlling the ionization light through the side windows
  - after 10 minutes stop the glow discharge and close the throttle valve
  - when the pressure is less than 7 microns close the roughing valve
  - open the foreline valve
  - close the holding valve
  - open the seal valve
  - open the bypass valve
  - when the pressure reaches  $5 \cdot 10^{-3}$  open high vacuum valve (The Meissner trap is not used)
  - when pressure reaches  $10^{-5}$ , control and analyze with the residual gas analyzer
  - film thickness monitor ON
  - in about 2 hours pressure reaches  $1.5 \cdot 10^{-6}$
  - start getter power supply. Bring up the power gradually until the correct temperature of the getter filaments is obtained. This is determined empirically by observing the colour of the filaments through the rear window. Hold for 10 to 15

- seconds to getter residual oxygen in the system
- turn off the residual gas analyzer
  - start evaporation procedure
  - filament power supply ON
  - start the power to the outer filaments for large mirror. Bring the power up to 400 amp. Increase the current by short cycles every 10 seconds until 800 amp is attained. Bring current up to 960 amp slightly faster until the thickness signal from the Kronos monitor crystal does not change
  - shut off power to filaments  
The maximum current required for small mirrors using the inner ring of filaments is 520 amp
  - shut high vacuum and bypass valve
  - shut: seal valve, LN<sub>2</sub> to diffusion pump, diffusion pump
  - open holding valve
  - shut foreline valve, booster pump and roughing pump
  - unscrew all the clamps around the cover
  - let chamber up to air by opening the two handwheels inlet valve (3 minutes)
  - disconnect the coaxial cable from the thickness sensor
  - open the chamber with the slow motion
  - remove the mirror
  - tilt the cover to adjust its parallelism with the tank
  - pump down the chamber

6. FIRM ADDRESSES

HVEC	- 2 Churchill Road Hingham, Mass. 02043
Kinney	- Vacuum Division 3529 Washington Street Boston, Mass. 02130
WELCH	- Scientific Company 7300 North Linder Avenue Skokie, Illinois
VARIAN	- Lexington Vacuum Division 121 Hartwell Avenue Lexington, Mass. 02173
AIRCO TEMESCAL	- 2850 Seventh Street Berkeley, California 94710
Leybold Heraus GMBH & CO KG	- Bonnerstrasse 504 5000 Köln 51
Veeco Instruments Inc.	- Terminal drive, plainview Long Island, New York 11803
KRONOS Inc.	- 20601 S. Annalee Avenue Carson, California 90746
MERCK	- Darmstadt, RFA
Nuclear Products Co.	- P.O. Box 5178 El Monte, California 91734

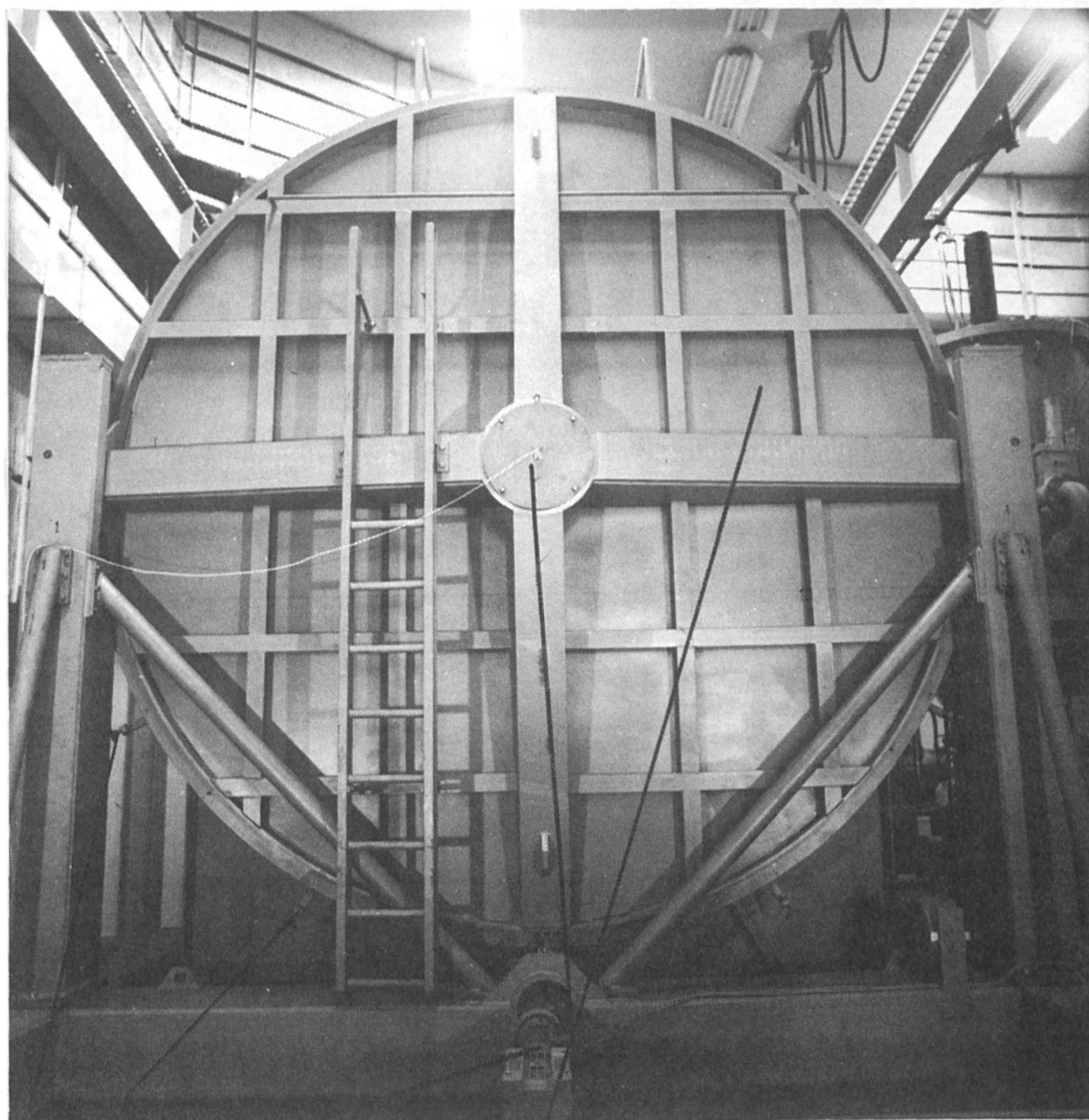

Carriage and drive assembly  
clamps

Connection and cooling  
of the crystal.  
Cover

FRONT VIEW OF THE PLANT

LN<sub>2</sub> COOLING TO MEISSNER TRAP

LN<sub>2</sub> TRAP

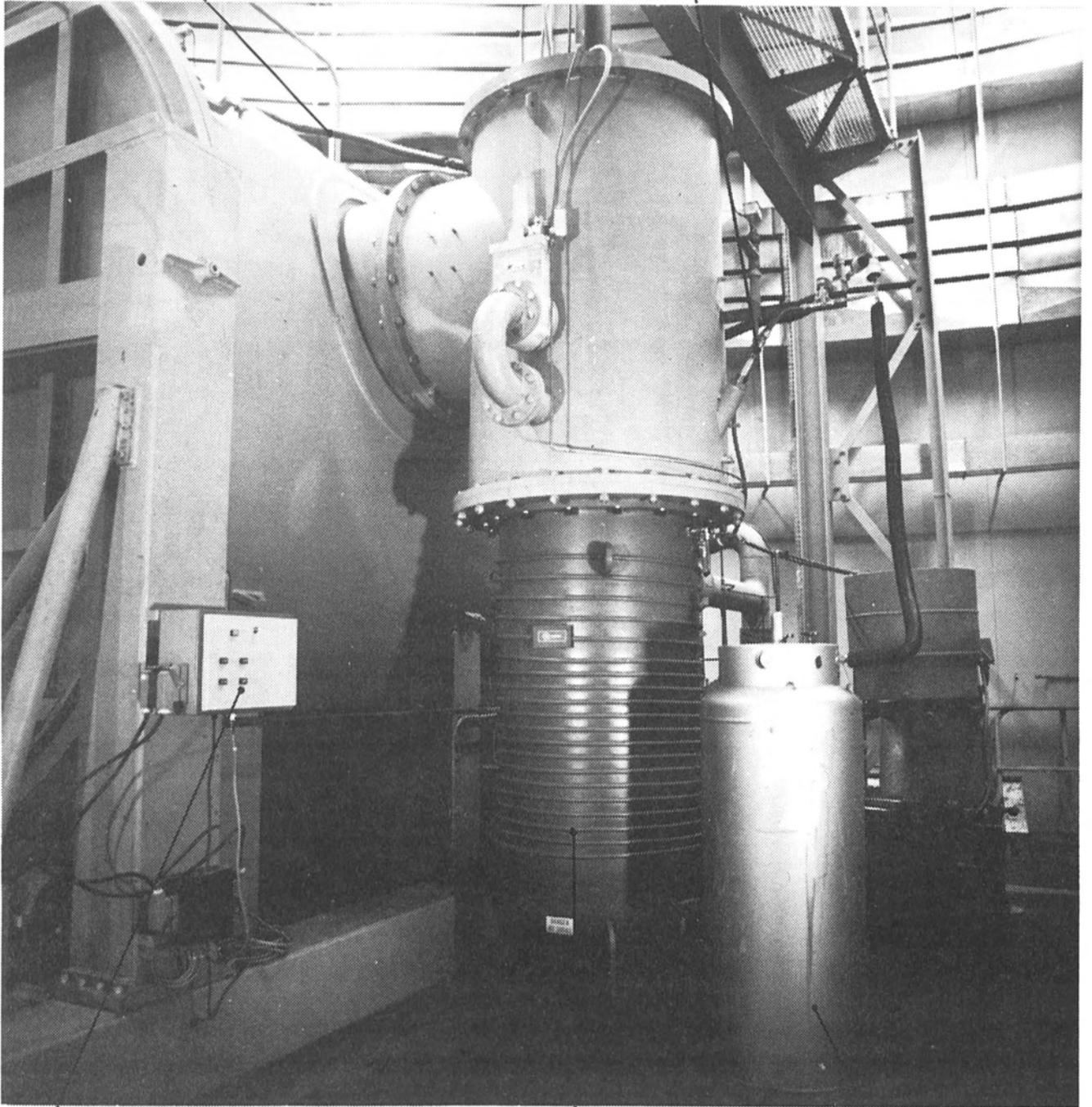

DRIVE ASSEMBLY COMMAND  
CONSOLE

DIFFUSION PUMP

LN<sub>2</sub> DEWAR

SIDE VIEW OF THE PLANT

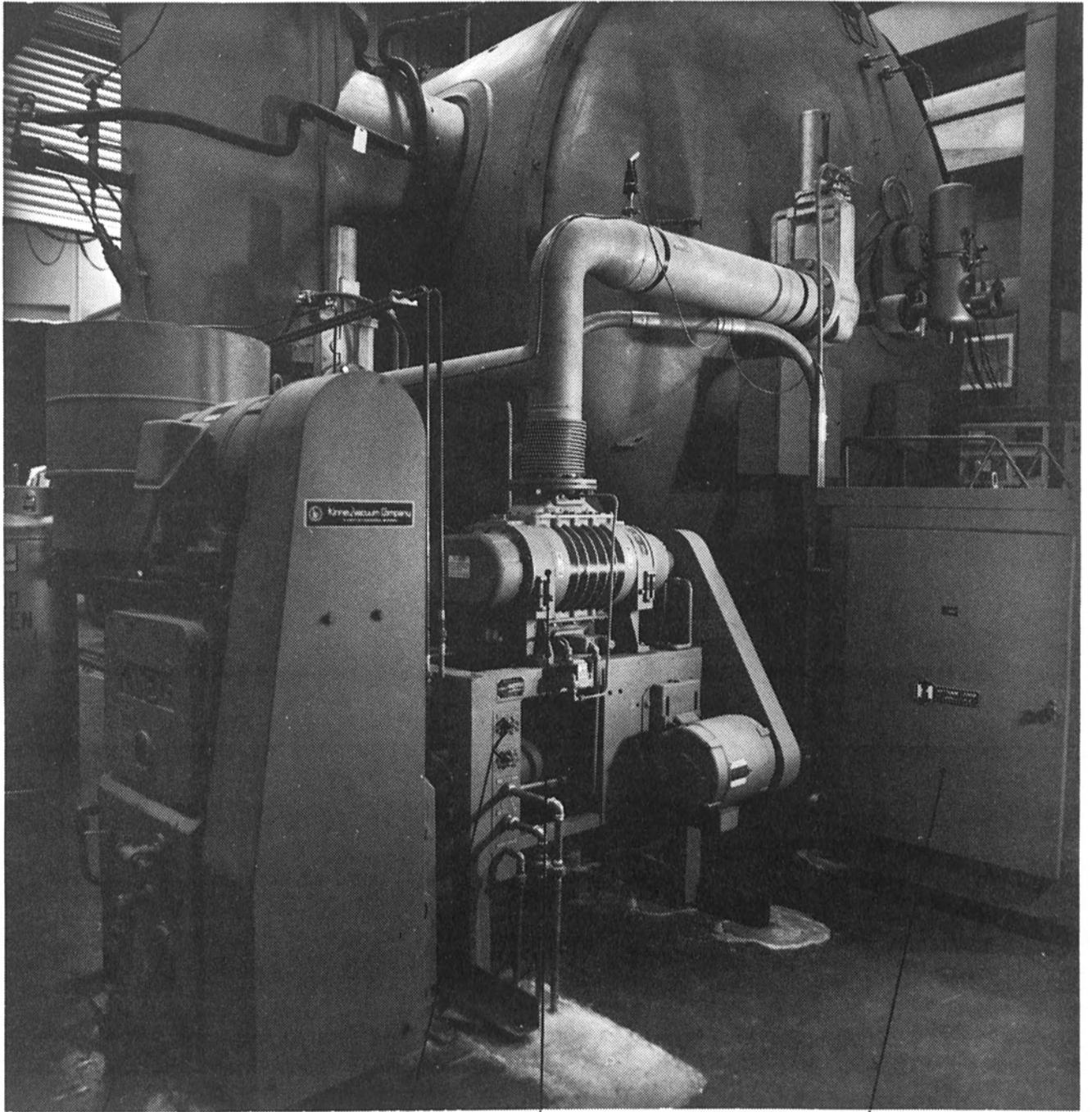

BOOSTER PUMP

WATER ON

ROOTS PUMP

POWER COMMAND

BACK VIEW OF THE PLANT

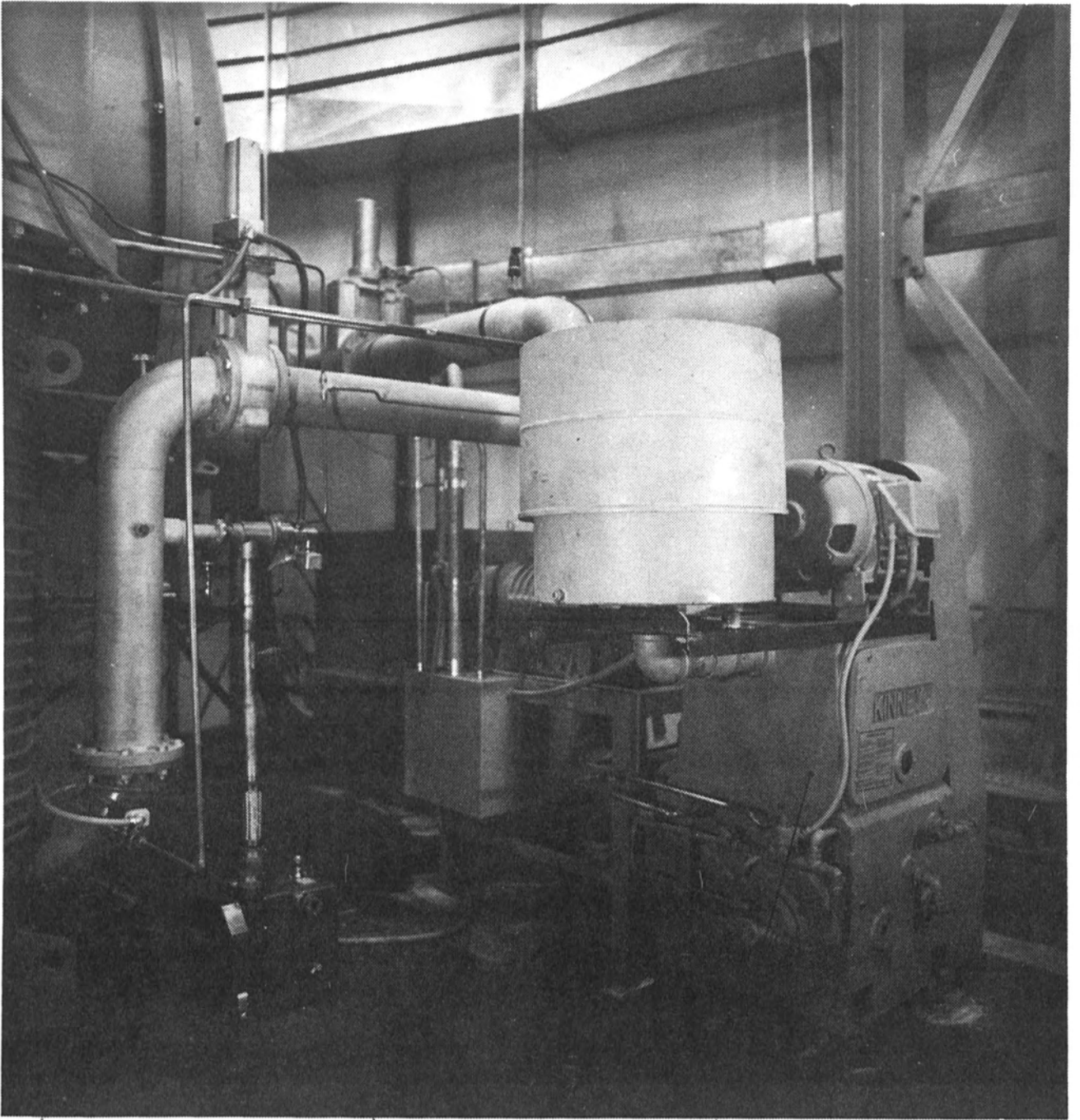

FLOW SWITCH FOR  
DIFFUSION PUMP

HOLDING PUMP

BOOSTER PUMP'S OIL

VACUUM PUMPS



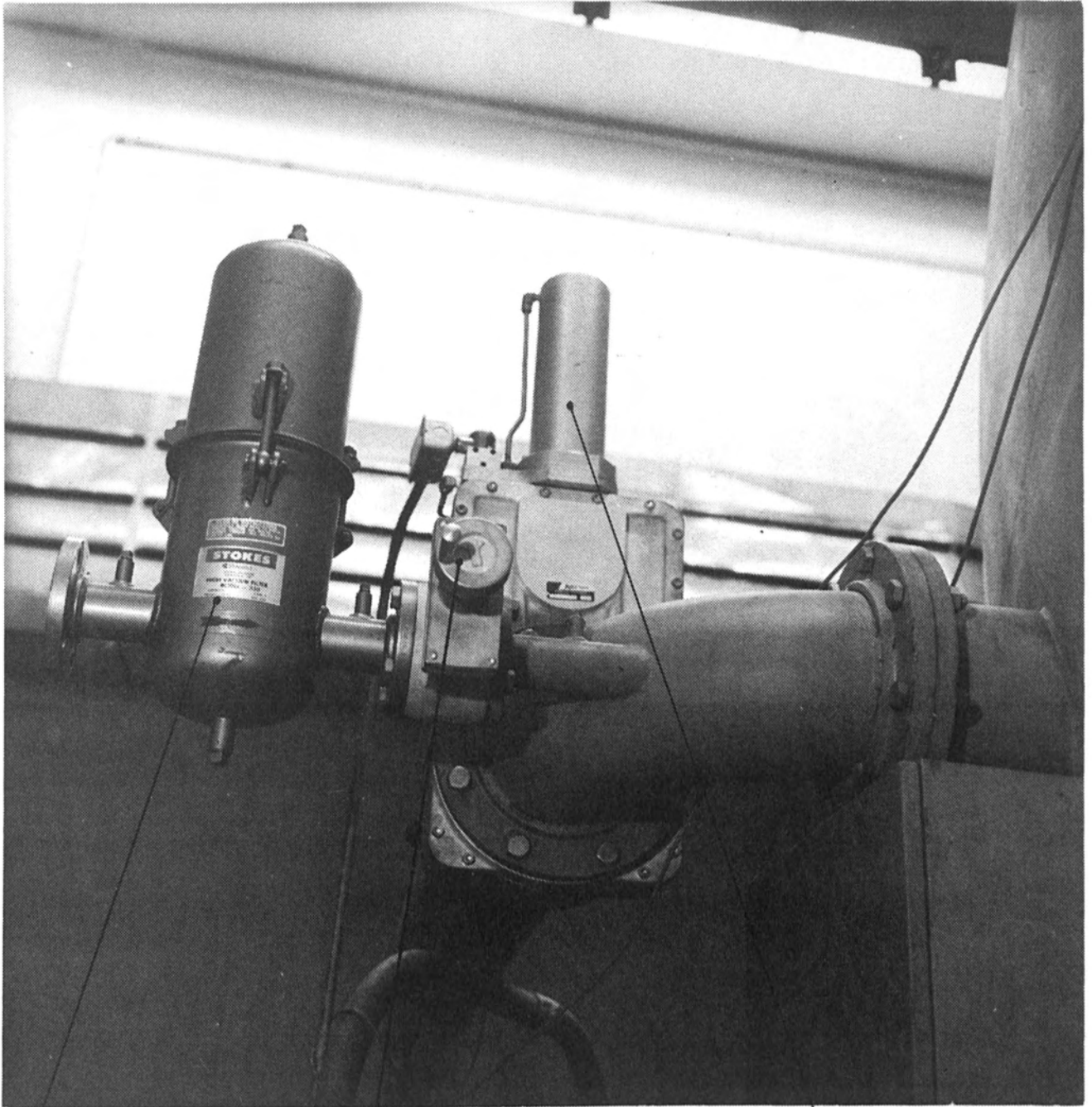

PIPE LINE FILTER  
AIR

HANDWHEEL ACTUATION  
FOR AIR ENTRANCE

ELECTRO-PNEUMATIC  
ACTUATION

GATE VALVES

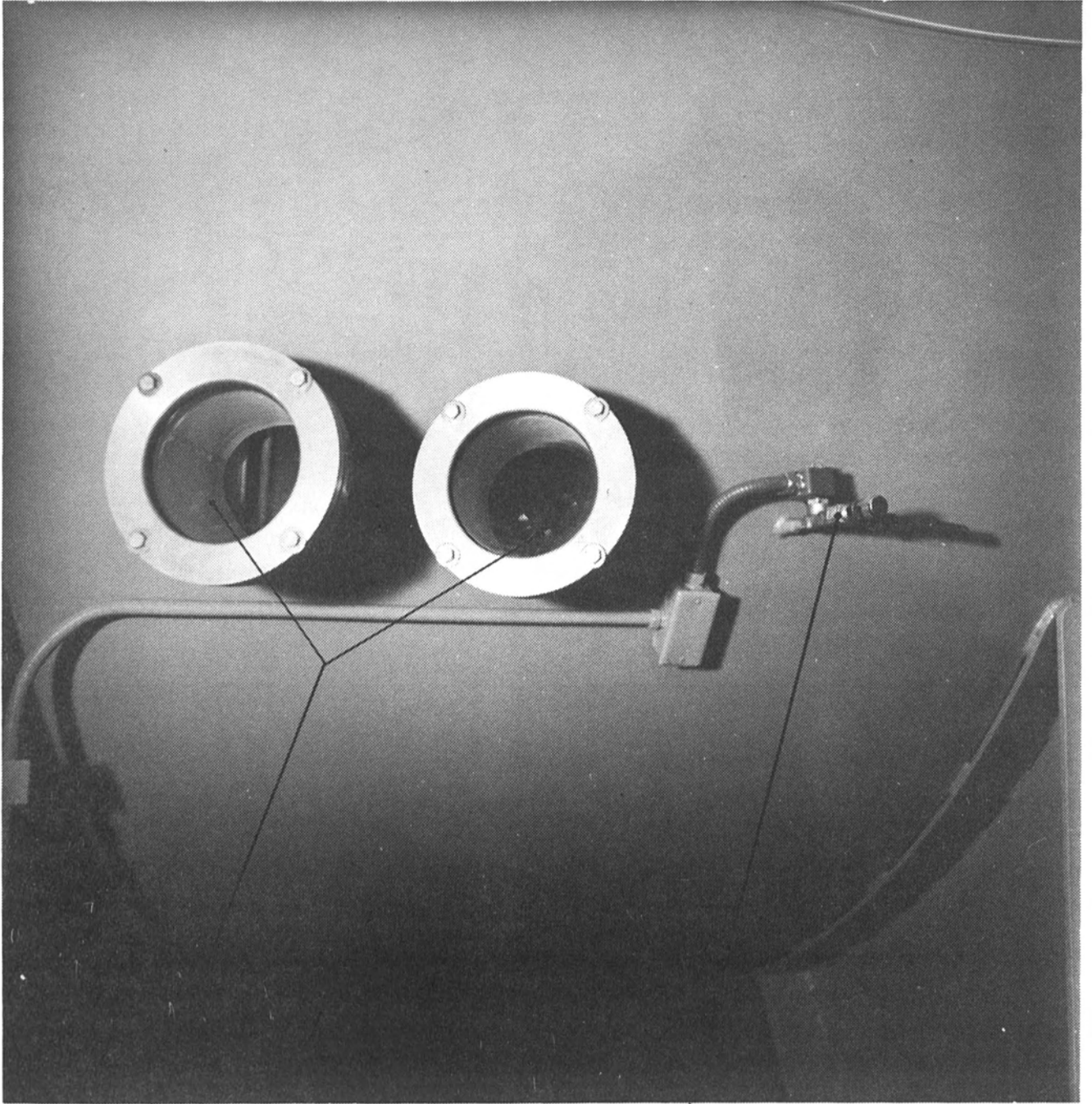

SIDE WINDOWS FOR  
FIRING CONTROL

THROTTLE VALVE

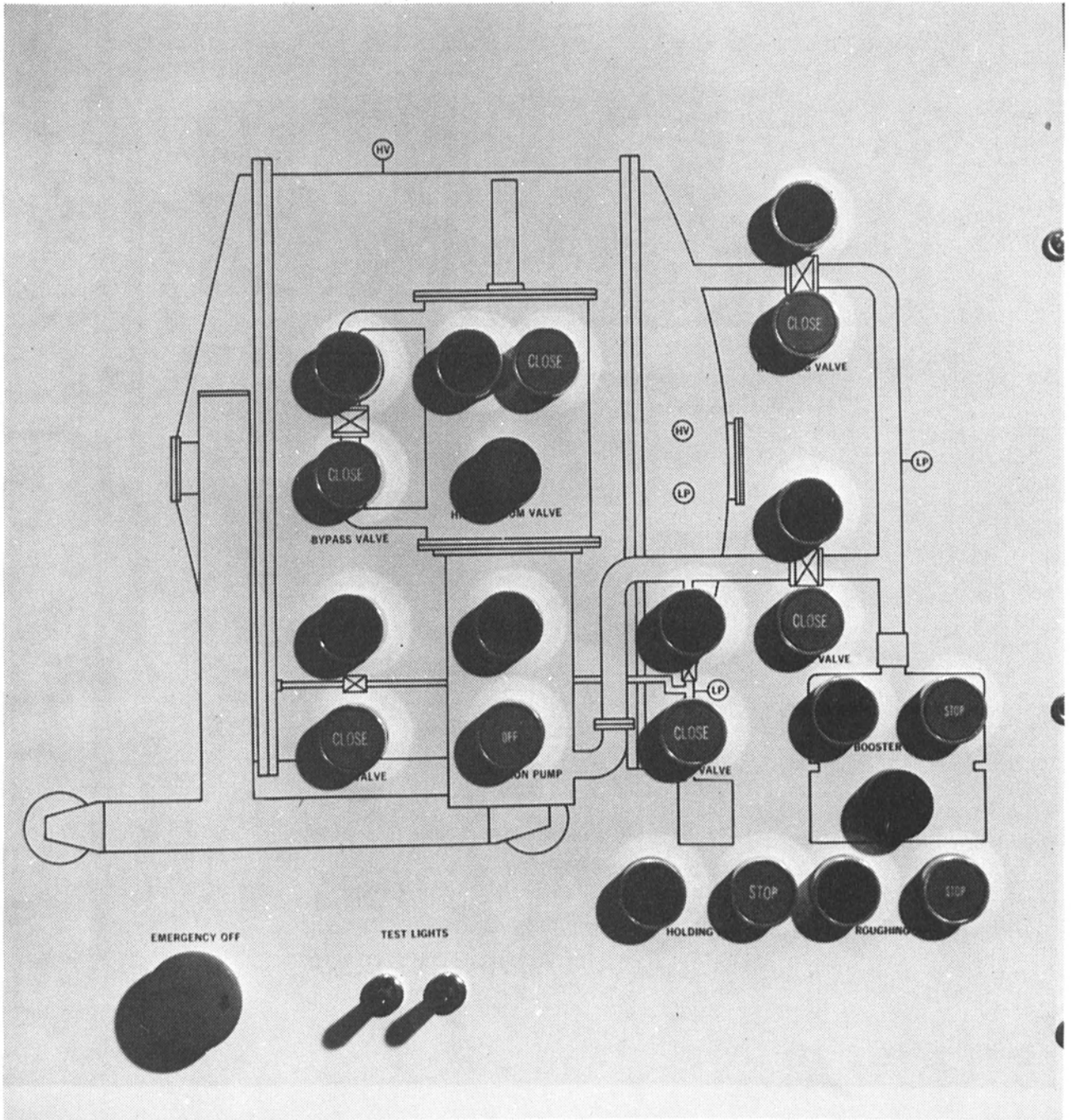

SYNOPSIS OF THE VACUUM PROCESS

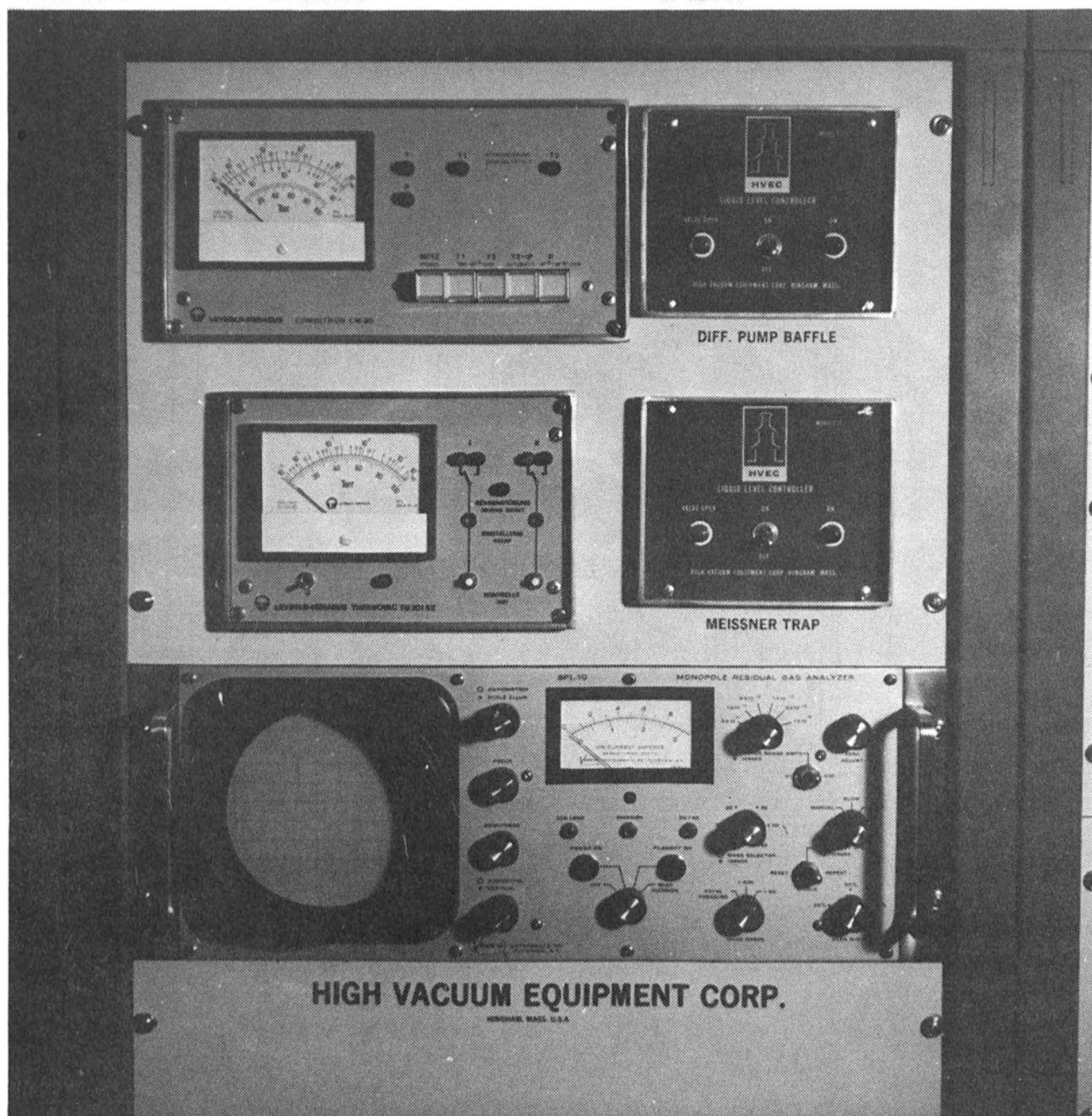

PRESSURE CONTROL PANEL

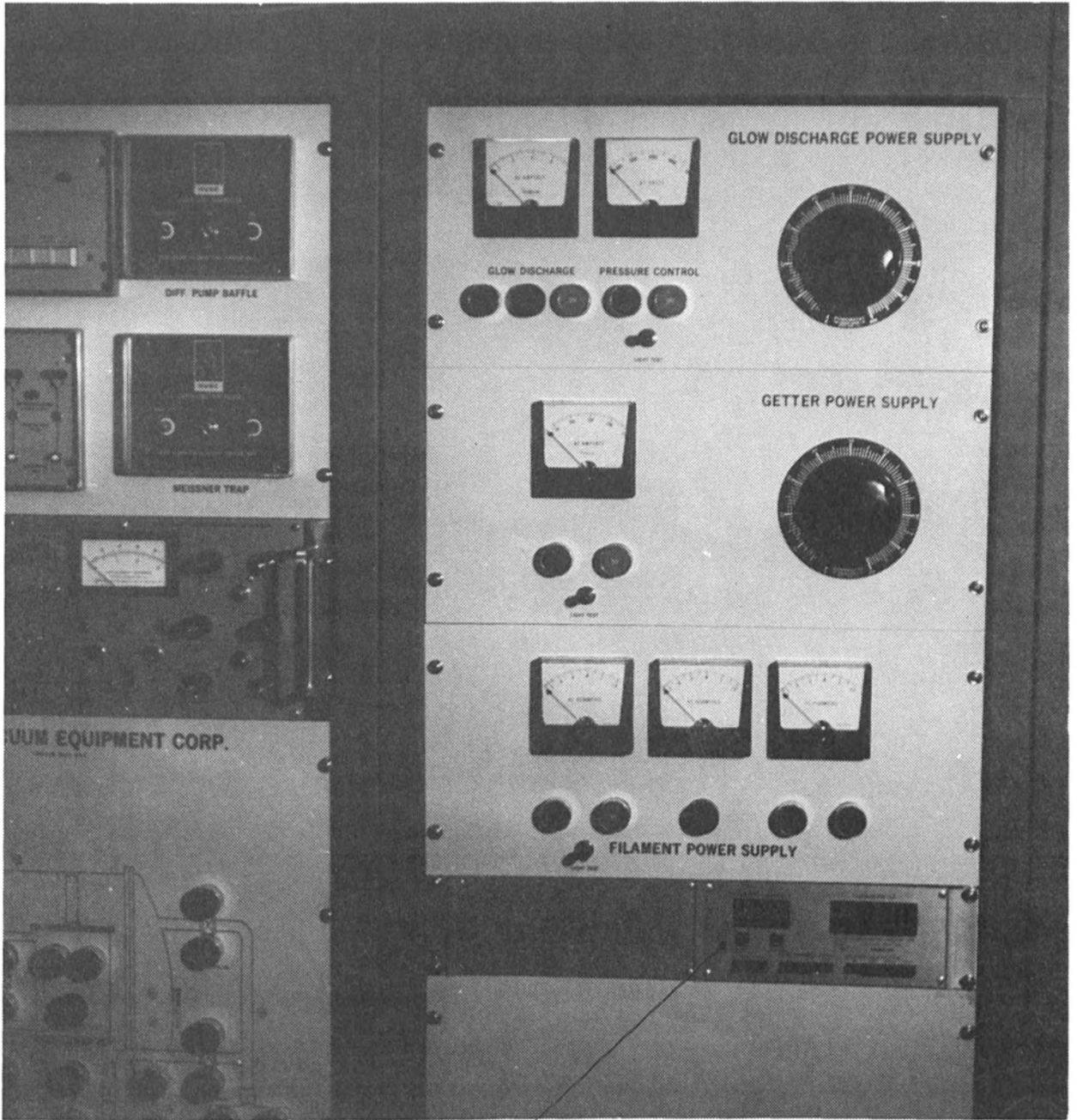

FILM THICKNESS MONITOR

FIRING CONTROL PANEL